



Industrial Automation Headquarters

Taiwan: Delta Electronics, Inc.

Taoyuan Technology Center
No.18, Xinglong Rd., Taoyuan District,
Taoyuan City 33068, Taiwan
TEL: +886-3-362-6301 / FAX: +886-3-371-6301

Asia

China: Delta Electronics (Shanghai) Co., Ltd.

No.182 Minyu Rd., Pudong Shanghai, P.R.C.
Post code : 201209
TEL: +86-21-6872-3988 / FAX: +86-21-6872-3996
Customer Service: 400-820-9595

Japan: Delta Electronics (Japan), Inc.

Industrial Automation Sales Department
2-1-14 Shibadaimon, Minato-ku
Tokyo, Japan 105-0012
TEL: +81-3-5733-1155 / FAX: +81-3-5733-1255

Korea: Delta Electronics (Korea), Inc.

1511, 219, Gasan Digital 1-Ro., Geumcheon-gu,
Seoul, 08501 South Korea
TEL: +82-2-515-5305 / FAX: +82-2-515-5302

Singapore: Delta Energy Systems (Singapore) Pte Ltd.

4 Kaki Bukit Avenue 1, #05-04, Singapore 417939
TEL: +65-6747-5155 / FAX: +65-6744-9228

India: Delta Electronics (India) Pvt. Ltd.

Plot No.43, Sector 35, HSIIDC Gurgaon,
PIN 122001, Haryana, India
TEL: +91-124-4874900 / FAX: +91-124-4874945

Thailand: Delta Electronics (Thailand) PCL.

909 Soi 9, Moo 4, Bangpoo Industrial Estate (E.P.Z),
Pattana 1 Rd., T.Phraksa, A.Muang,
Samutprakarn 10280, Thailand
TEL: +66-2709-2800 / FAX: +66-2709-2827

Australia: Delta Electronics (Australia) Pty Ltd.

Unit 2, Building A, 18-24 Ricketts Road,
Mount Waverley, Victoria 3149 Australia
Mail: IA.au@deltaww.com
TEL: +61-1300-335-823 / +61-3-9543-3720

Americas

USA: Delta Electronics (Americas) Ltd.

5101 Davis Drive, Research Triangle Park, NC 27709, U.S.A.
TEL: +1-919-767-3813 / FAX: +1-919-767-3969

Brazil: Delta Electronics Brazil Ltd.

Estrada Velha Rio-São Paulo, 5300 Eugênio de
Melo - São José dos Campos CEP: 12247-004 - SP - Brazil
TEL: +55-12-3932-2300 / FAX: +55-12-3932-237

Mexico: Delta Electronics International Mexico S.A. de C.V.

Gustavo Baz No. 309 Edificio E PB 103
Colonia La Loma, CP 54060
Tlalnepantla, Estado de México
TEL: +52-55-3603-9200

EMEA

EMEA Headquarters: Delta Electronics (Netherlands) B.V.

Sales: Sales.IA.EMEA@deltaww.com
Marketing: Marketing.IA.EMEA@deltaww.com
Technical Support: iatechnicalsupport@deltaww.com
Customer Support: Customer-Support@deltaww.com
Service: Service.IA.emea@deltaww.com
TEL: +31(0)40 800 3900

BENELUX: Delta Electronics (Netherlands) B.V.

Automotive Campus 260, 5708 JZ Helmond, The Netherlands
Mail: Sales.IA.Benelux@deltaww.com
TEL: +31(0)40 800 3900

DACH: Delta Electronics (Netherlands) B.V.

Coesterweg 45, D-59494 Soest, Germany
Mail: Sales.IA.DACH@deltaww.com
TEL: +49(0)2921 987 0

France: Delta Electronics (France) S.A.

ZI du bois Challand 2, 15 rue des Pyrénées,
Lisses, 91090 Evry Cedex, France
Mail: Sales.IA.FR@deltaww.com
TEL: +33(0)1 69 77 82 60

Iberia: Delta Electronics Solutions (Spain) S.L.U

Ctra. De Villaverde a Vallecas, 265 1º Dcha Ed.
Hormigueras - P.I. de Vallecas 28031 Madrid
TEL: +34(0)91 223 74 20

Carrer Llacuna 166, 08018 Barcelona, Spain

Mail: Sales.IA.Iberia@deltaww.com

Italy: Delta Electronics (Italy) S.r.l.

Via Meda 2-22060 Novedrate(CO)
Piazza Grazioli 18 00186 Roma Italy
Mail: Sales.IA.Italy@deltaww.com
TEL: +39 039 8900365

Russia: Delta Energy System LLC

Vereyskaya Plaza II, office 112 Vereyskaya str.
17 121357 Moscow Russia
Mail: Sales.IA.RU@deltaww.com
TEL: +7 495 644 3240

Turkey: Delta Greentech Elektronik San. Ltd. Sti. (Turkey)

Şerifali Mah. Hendem Cad. Kule Sok. No:16-A
34775 Ümraniye - İstanbul
Mail: Sales.IA.Turkey@deltaww.com
TEL: + 90 216 499 9910

MEA: Eltek Dubai (Eltek MEA DMCC)

OFFICE 2504, 25th Floor, Saba Tower 1,
Jumeirah Lakes Towers, Dubai, UAE
Mail: Sales.IA.MEA@deltaww.com
TEL: +971(0)4 2690148

Delta Sensorless Vector Control Compact Drive VFD-EL-W Series



Digitized Automation for a Changing World

Delta Sensorless Vector Control Compact Drive VFD-EL-W Series



www.deltaww.com

*We reserve the right to change the information in this manual without prior notice.

DELTA_IA-MDS_VFD-EL-W_UM_EN_20230221

Send Quote Requests to info@automatedpt.com
Call +1(800)985-6929 To Order or Order Online At Deltaacdrives.com



Copyright notice

©Delta Electronics, Inc. All rights reserved.

All information contained in this user manual is the exclusive property of Delta Electronics Inc. (hereinafter referred to as "Delta ") and is protected by copyright law and all other laws. Delta retains the exclusive rights of this user manual in accordance with the copyright law and all other laws. No parts in this manual may be reproduced, transmitted, transcribed, translated or used in any other ways without the prior consent of Delta.

Limitation of Liability

The contents of this user manual are only for the use of the AC motor drives manufactured by Delta. Except as defined in special mandatory laws, Delta provides this user manual "as is" and does not offer any kind of warranty through this user manual for using the product, either express or implied, including but not limited to the following: (i) this product will meet your needs or expectations; (ii) the information contained in the product is current and correct; (iii) the product does not infringe any rights of any other person. You shall bear your own risk to use this product.

In no event shall Delta, its subsidiaries, affiliates, managers, employees, agents, partners and licensors be liable for any direct, indirect, incidental, special, derivative or consequential damages (including but not limited to the damages for loss of profits, goodwill, use or other intangible losses) unless the laws contains special mandatory provisions to the contrary.

Delta reserves the right to make changes to the user manual and the products described in the user manual without prior notice and afterwards.

READ PRIOR TO INSTALLATION FOR SAFETY.



- ☑ Disconnect AC input power before connecting any wiring to the AC motor drive.
- ☑ Even if the power has been turned off, a charge may still remain in the DC-link capacitors with hazardous voltages before the POWER LED is OFF. Do NOT touch the internal circuits and components.
- ☑ There are highly sensitive MOS components on the printed circuit boards. These components are especially sensitive to static electricity. Take anti-static measure before touching these components or the circuit boards.
- ☑ Never modify the internal components or wiring.
- ☑ Ground the AC motor drive by using the ground terminal. The grounding method must comply with the laws of the country where the AC motor drive is to be installed.
- ☑ Do NOT install the AC motor drive in a location with high temperature, direct sunlight or inflammable materials or gases.



- ☑ Never connect the AC motor drive output terminals U/T1, V/T2 and W/T3 directly to the AC mains circuit power supply.
- ☑ After finishing the wiring of the AC motor drive, check if U/T1, V/T2, and W/T3 are short-circuited to ground with a multimeter. Do NOT power the drive if short circuits occur. Eliminate the short circuits before the drive is powered.
- ☑ The rated voltage of power system to install motor drives is listed below. Ensure that the installation voltage is in the correct range when installing a motor drive.
 1. For 230V models, the range is between 180–264V.
 2. For 460V models, the range is between 342–528V.
- ☑ Only qualified persons are allowed to install, wire and maintain the AC motor drives.
- ☑ Even if the three-phase AC motor is stopped, a charge with hazardous voltages may still remain in the main circuit terminals of the AC motor drive.
- ☑ The performance of electrolytic capacitor will degrade if it is not charged for a long time. It is recommended to charge the drive that is stored in no charge condition every 2 years for 3–4 hours to restore the performance of electrolytic capacitor in the motor drive. **NOTE:** When power up the motor drive, use adjustable AC power source (ex. AC autotransformer) to charge the drive at 70–80% of rated voltage for 30 minutes (do not run the motor drive). Then charge the drive at 100% of rated voltage for an hour (do not run the motor drive). By doing these, restore the performance of electrolytic capacitor before starting to run the motor drive. Do NOT run the motor drive at 100% rated voltage right away.
- ☑ Pay attention to the following precautions when transporting and installing this package (including wooden crate and wood stave)
 1. If you need to deworm the wooden crate, do NOT use fumigation or you will damage the drive. Any damage to the drive caused by using fumigation voids the warranty.
 2. Use other methods, such as heat treatment or any other non-fumigation treatment, to deworm the wood packaging material.
 3. If you use heat treatment to deworm, leave the packaging materials in an environment of over 56°C for a minimum of thirty minutes.
- ☑ Connect the drive to a three-phase three-wire or three-phase four-wire Wye system to comply with UL standards.
- ☑ If the motor drive generates leakage current over AC 3.5 mA or over DC 10 mA on a grounding conductor, compliance with local grounding regulations or IEC61800-5-1 standard is the minimum requirement for grounding.

NOTE: The content of this manual may be revised without prior notice. Consult our distributors or download the latest version at http://www.deltaww.com/iadownload_acmotordrive

Table of Contents

Chapter 1 Introduction.....	1
1-1 Receiving and Inspection	3
1-2 Preparation for Installation and Wiring	8
1-3 Dimensions.....	11
Chapter 2 Installation and Wiring.....	15
2-1 Wiring	17
2-2 External Wiring	21
2-3 Main Circuit	22
2-4 Control Terminals	25
2-5 NPN / PNP Mode	28
Chapter 3 Keypad and Start-up	29
3-1 Description of the Digital Keypad	31
3-2 Operation Method	34
3-3 Trial Run.....	35
Chapter 4 Parameters	37
4-1 Summary of Parameter Settings.....	39
4-2 Parameter Settings for Applications.....	60
4-3 Description of Parameter Settings	64
00 User Parameters	64
01 Basic Parameters.....	71
02 Operation Method Parameters.....	79
03 Output Function Parameters.....	87
04 Input Function Parameters.....	91
05 Multi-step Speed Operation	103
06 Protection Parameters	104
07 Motor Parameters	110
08 Special Parameters.....	115
09 Communication Parameters	121
10 PID Control Parameters.....	133
4-4 Adjustment and Application	145
Chapter 5 Troubleshooting	159
5-1 Over-Current (oc)	160
5-2 Over-Voltage (ov)	161
5-3 Low Voltage (Lv)	162
5-4 Overheat (oH1)	163
5-5 Overload (oL)	164
5-6 Keypad Display is Abnormal	165
5-7 Phase Loss (PHL).....	166
5-8 Motor Does Not Run	167

5-9 Motor Speed Cannot be Changed	168
5-10 Motor Stalls during Acceleration.....	169
5-11 The Motor Does Not Run as Expected.....	170
5-12 Electromagnetic/Induction Noise.....	171
5-13 Operating Environment Condition	172
5-14 Affecting Other Machines	173
Chapter 6 Fault Code Information and Maintenance	175
6-1 Fault Code Information.....	177
6-2 Maintenance and Inspections	181
Appendix A. Specifications	185
A-1 230V 1φ Models.....	187
A-2 460V 3φ Models.....	188
A-3 General Specifications	189
A-4 Environment for Operation, Storage and Transportation.....	190
A-5 Derating Curve for Ambient Temperature and Carrier Frequency	191
Appendix B. Accessories	193
B-1 Non-fuse Circuit Breaker Chart.....	194
B-2 Reactor	195
B-3 Digital Keypad.....	198
B-4 Auxiliary Cooling Fan	203
Appendix C. How to Select the Right AC Motor Drive	205
C-1 Capacity Formulas.....	207
C-2 General Precautions	209
C-3 How to Choose a Suitable Motor.....	210

Issued Edition: 00

Firmware Version: V2.04 (Refer to Pr.00-06 on the product for the firmware version.)

Issued Date: 2023/02

Chapter 1 Introduction

1-1 Receiving and Inspection

1-2 Preparation for Installation and Wiring

1-3 Dimensions

Chapter 1 Introduction | VFD-EL-W

Keep the AC motor drive in the shipping carton or crate before installation. In order to retain the warranty coverage, properly store the AC motor drive when it is not to be used for an extended period of time. The proper storage conditions are listed below.

**CAUTION**

- ☑ Store in a clean and dry location without any direct sunlight or corrosive fumes.
- ☑ Store in an ambient temperature range between -20°C to +60°C.
- ☑ Store in a relative humidity range between 0% to 90% and non-condensing environment.
- ☑ DO NOT store in the environment with corrosive gas or liquid.
- ☑ DO NOT place directly on the ground. If the surrounding environment is humid, you should put a desiccant in the carton or crate.
- ☑ DO NOT store in an area with rapid changes in temperature that may cause condensation or frost to form.
- ☑ If the AC motor drive is stored for more than three months, the temperature should not be higher than 30°C. Storage for longer than one year is not recommended; it could result in the degradation of the electrolytic capacitors.
- ☑ When the AC motor drive is not used for long time after installation in an environment with humidity and dust, it is the best to move the AC motor drive to a better environment as stated above.

1-1 Receiving and Inspection

This VFD-EL-W AC motor drive has gone through rigorous quality control tests at the factory before shipment. After receiving the AC motor drive, please check for the following:

- ☑ Inspect the unit to ensure it was not damaged during shipment.
- ☑ Make sure that the part number indicated on the nameplate matches the part number of your order.
- ☑ If the nameplate information does not match your purchase order or if there are any problems, please contact your distributor

Nameplate Information

Example for 1 HP/0.75 kW three-phase 230V AC motor drive

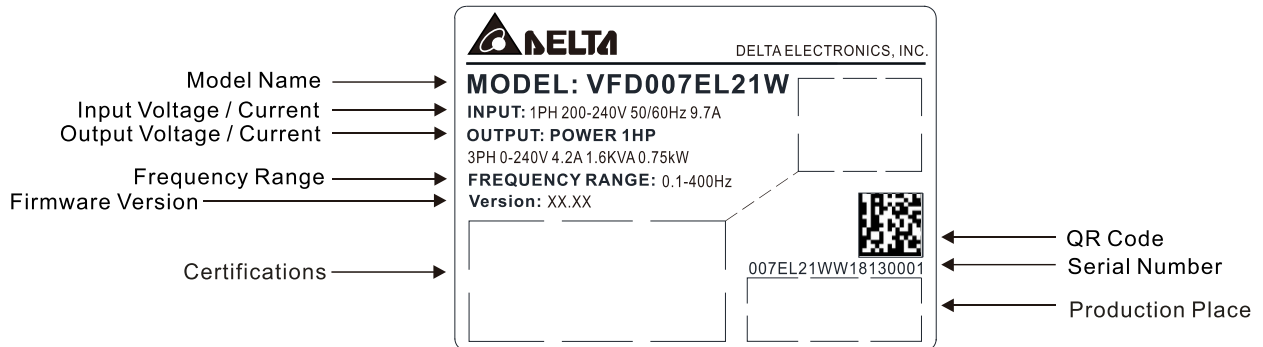

Model Name

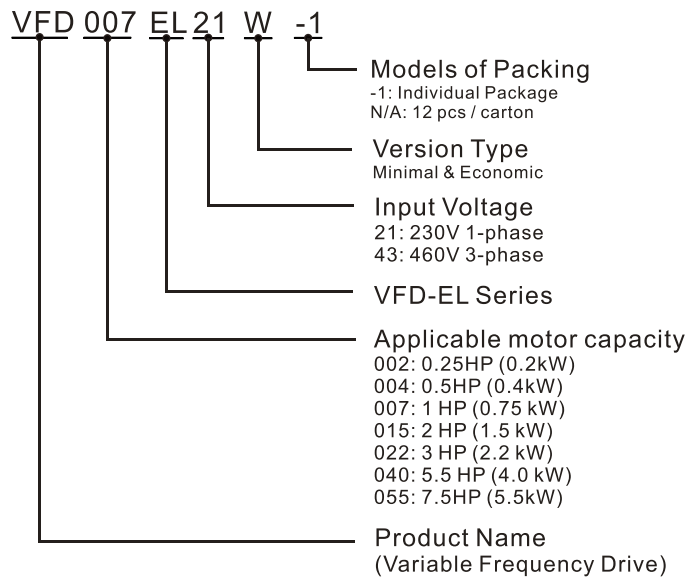

Serial Number

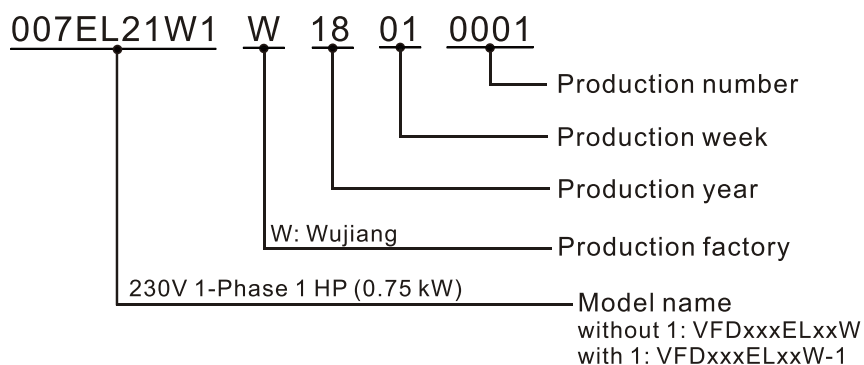

Chapter 1 Introduction | VFD-EL-W

Drive Frames and Appearances

Frame A1

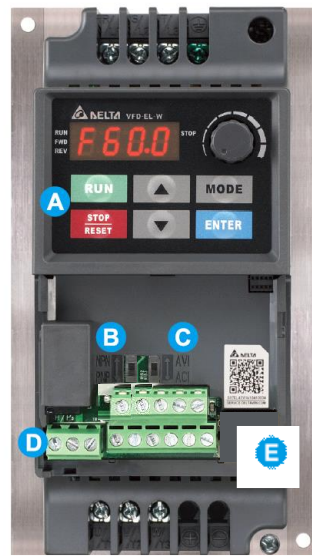

Frame A2

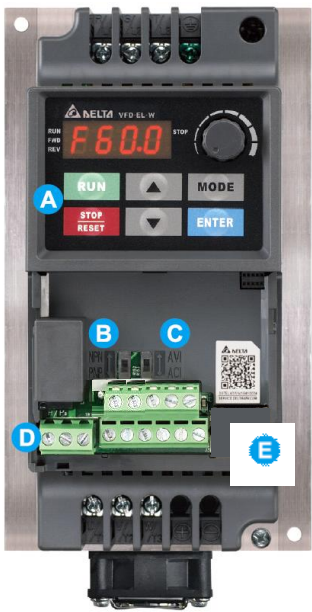

Frame B

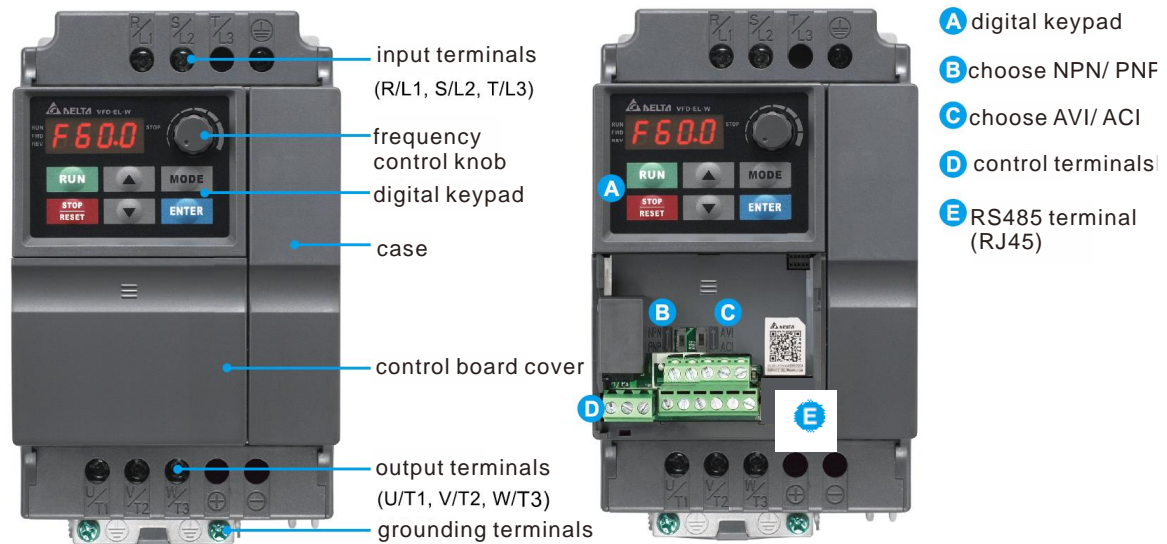

Frame	Power Range	Models
A1	0.25–1 HP (0.2–0.75 kW)	VFD002EL21W(-1), VFD004EL21W(-1) / 43W(-1), VFD007EL21W(-1) / 43W(-1)
A2	2 HP (1.5 kW)	VFD015EL43W(-1)
B	2–7.5 HP (1.5–5.5 kW)	VFD015EL21W(-1), VFD022EL21W / 43W(-1), VFD040EL43W(-1), VFD055EL43W(-1)

RFI Jumper Location

**NOTE:**

RFI jumper of Frame A1, A2 and B is near the input terminals (R/L1, S/L2, T/L3), as the red circle shows in the figure above. You can remove the RFI jumper by loosening the screws.

Chapter 1 Introduction | VFD-EL-W**RFI Jumper**

1. The drive contains Varistors / MOVs that are connected from phase to phase and from phase to ground to prevent the drive from unexpected stop or damage caused by main surges or voltage spikes. Because the Varistors / MOVs from phase to ground are connected to ground with the RFI jumper, removing the RFI jumper disables the protection.
2. In models with a built-in EMC filter, the RFI jumper connects the filter capacitors to ground to form a return path for high frequency noise in order to isolate the noise from contaminating the main power. Removing the RFI jumper strongly reduces the effect of the built-in EMC filter. Although a single drive complies with international standards for leakage current, an installation with several drives with built-in EMC filters can trigger the RCD. Removing the RFI jumper helps, but the EMC performance of each drive is no longer guaranteed.

Isolating main power from ground:

When the power distribution system for the drive is a floating ground system (IT) or an asymmetric ground system (Corner Grounded TN Systems), you must remove the RFI jumper. Removing the RFI jumper disconnects the internal capacitors from ground to avoid damaging the internal circuits and to reduce the ground leakage current.

Important points regarding ground connection

- Do not remove RFI jumper while the power is ON.
- Make sure that main power is OFF before removing the RFI jumper.
- Removing the RFI jumper also cuts off the built-in EMC filter capacitors. Compliance with the EMC specifications is no longer guaranteed.

If you remove the RFI jumper, you remove the reliable electrical isolation. In other words, all controlled inputs and outputs become low-voltage terminals with basic electrical isolation. Also, when you remove the internal RFI jumper, the motor drive is no longer electromagnetic compatible (EMC).

- Do not remove the RFI jumper if the main power is a grounded power system to make EMC filter effective
- You must remove the RFI jumper when conducting high voltage tests. When conducting a high voltage test for the entire facility, disconnect the main power and the motor if the leakage current is too high.
- To prevent damage to the drive, you must remove the RFI jumper connected to ground if the AC motor drive is installed on an ungrounded power system or a high resistance-grounded (greater than 30 Ω) power system or a corner grounded TN system.

Remove the control board cover

As shown in Step 1 below, gently press the control board cover. Then, as shown in Step 2, pull it down slowly to remove it.



Step 1



Step 2

Remove cooling fan:

To remove the cooling fan of Frame B, gently release the clips on both sides of the cooling fan.



Chapter 1 Introduction | VFD-EL-W**1-2 Preparation for Installation and Wiring****Ambient Conditions**

Install the AC motor drive in an environment with the following conditions.

Operation	Temperature	-10–50°C (14–122°F) (Excluding VFD007EL21W/ VFD007EL21W-1)
	Relative Humidity	< 90%, non-condensing
	Atmospheric pressure	86–106 kPa
	Installation Site Altitude	<1000 m
	Vibration	1.0 mm, peak-to-peak value: from 2–13.2 Hz; 0.7–1.0 G, from 13.2–55 Hz; 1.0 G, from 55–512 Hz; compliance with IEC 60068-2-6 standard.
Storage and Transportation	Temperature	-20–60°C (-4–140°F)
	Relative Humidity	< 90%, non-condensing
	Atmospheric pressure	86–106 kPa
	Vibration	1.0 mm, peak-to-peak value: from 2–13.2 Hz; 0.7–1.0 G, from 13.2–55 Hz; 1.0 G, from 55–512 Hz; compliance with IEC 60068-2-6 standard.
Pollution Degree	2: good for a factory type environment.	

Minimum Mounting Clearance

← (Blue arrow) Inflow

→ (Red arrow) Outflow

↔ (Black) Distance

Single Drive Installation

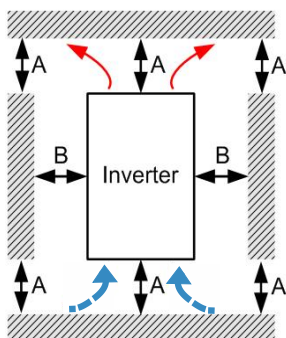

Side-by-Side Horizontal Installation

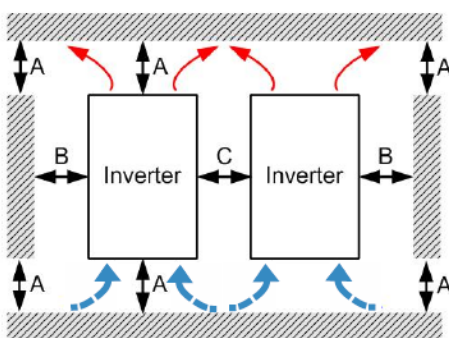

Zero-stack Installation

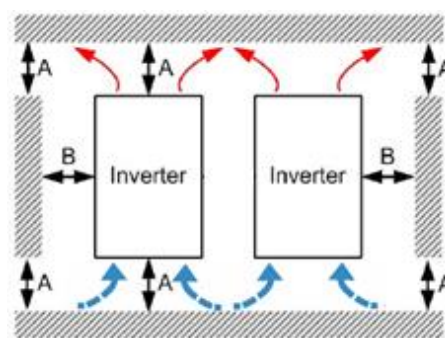

Model Name	Installation Method	Minimum Distance (mm)			Temperature °C	
		A	B	C ^{Note 1}	Max.(Derating is not required)	Max.(Derating is required) ^{Note 3}
VFD007EL21W(-1)	Single Drive	120	50	-	40	50
	Side-by-Side Horizontal	120	50	30	40	50
	Zero-stack ^{Note 2}	-	-	-	-	-
VFD007EL43W(-1) VFD015EL43W(-1)	Single Drive	120	50	-	50	60
	Side-by-Side Horizontal	120	50	30	50	60
	Zero-stack	-	-	-	-	-
VFD015EL21W(-1) VFD022EL21W(-1) VFD022EL43W(-1) VFD040EL43W(-1) VFD055EL43W(-1)	Single Drive	150	50	-	50	60
	Side-by-Side Horizontal	150	50	30	50	60
	Zero-stack	150	50	0	40	50

NOTE:

- Due to a small protruding part of the heat sink at the bottom of the Frame A1/ A2, we calculate the distance C for the side-by-side horizontal installation according to the main part of the motor drive only.
- Frame A1 and A2 does not support zero-stack installation, whereas Frame B supports zero-stack installation.
- Running the drive continuously with full load by the ambient temperature listed in the "Max. (derating)" column reduces the drive's life span.
- Install the drive vertically to achieve the optimal heat dissipation performance.
- The back surface of the drive for installation must be a metal material with higher temperature endurance and good heat dissipation.

Chapter 1 Introduction | VFD-EL-W

- ☑ Mount the AC motor drive vertically on a flat vertical surface with screws. Other mounting directions are not allowed.
- ☑ The AC motor drive generates heat during operation. Allow sufficient space around the unit for heat dissipation. When you install the AC motor drive in a confined space (for example a cabinet), the surrounding temperature must meet specifications of operation (as shown in chapter 1.2.1) with good ventilation. DO NOT install the AC motor drive in a space with poor ventilation.
- ☑ The heat sink temperature may rise to 90°C when running. The metallic material on which the AC motor drive is mounted must be noncombustible, be excellent at thermal dissipation and be able to withstand this high temperature.
- ☑ When installing multiple AC motor drives in the same cabinet, mount them in a row with enough space between for ventilation. When installing one AC motor drive below another one, use a metal separator between the AC motor drives to prevent mutual heating.

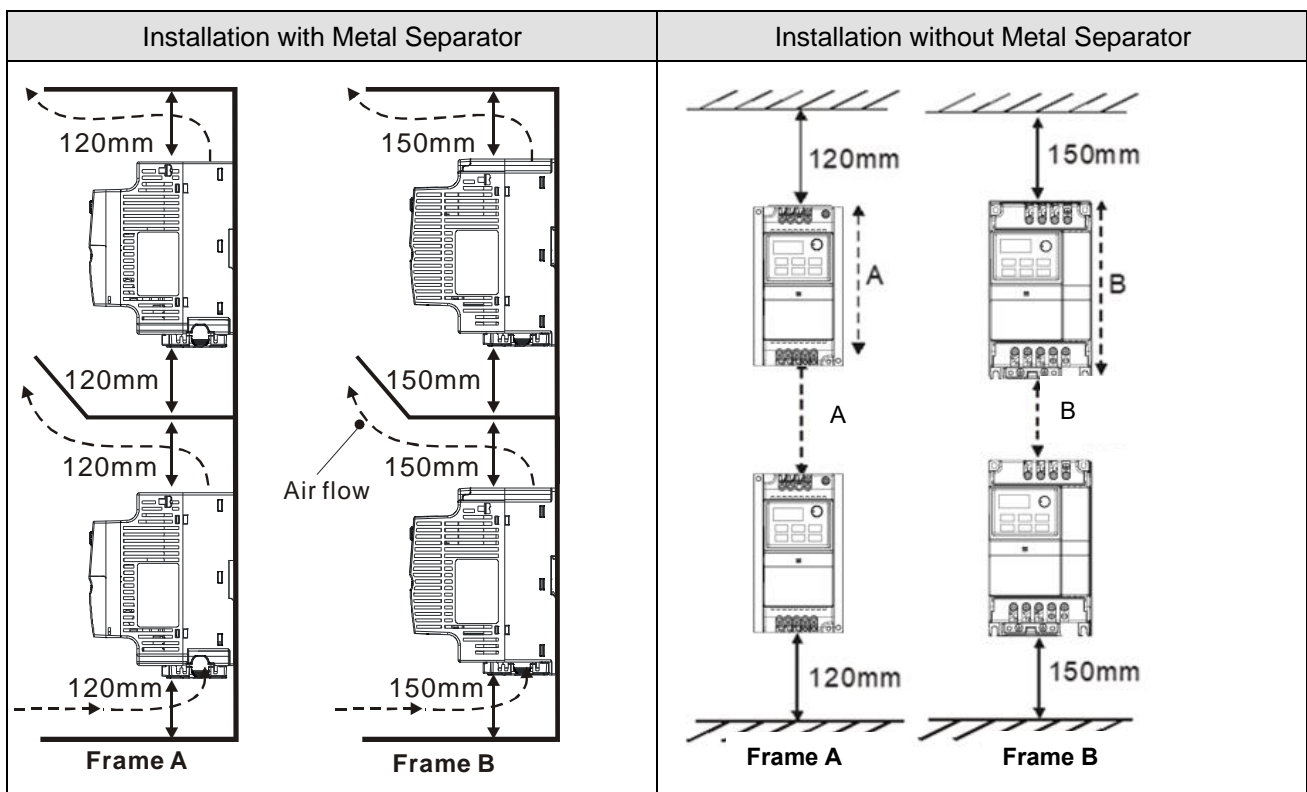
**NOTE:**

1. Prevent fiber particles, scraps of paper, shredded wood, sawdust, metal particles, etc. from adhering to the heat sink.
2. Install the AC motor drive in a metal cabinet to prevent the risk of fire accident.

1-3 Dimensions

Frame A1

VFD002EL21W(-1), VFD004EL21W(-1), VFD004EL43W(-1), VFD007EL21W(-1), VFD007EL43W(-1)

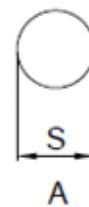
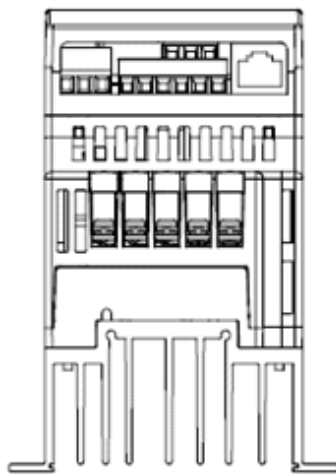
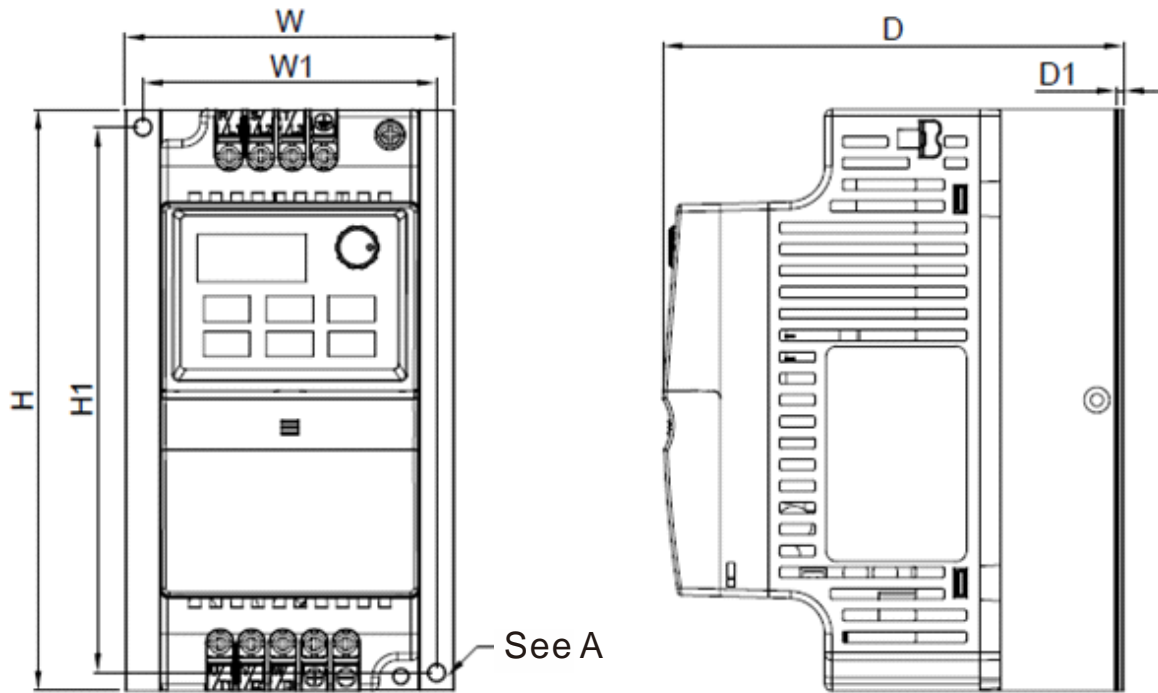

(mounting hole)

Unit: mm (inch)

Frame	W	W1	H	H1	D	D1	S1
A1	92.0 (3.62)	82.0 (3.23)	162.0 (6.38)	152 (5.98)	128.7 (5.07)	5.4 (0.21)	5.4 (0.21)

Chapter 1 Introduction | VFD-EL-W

Frame A2

VFD015EL43W(-1)

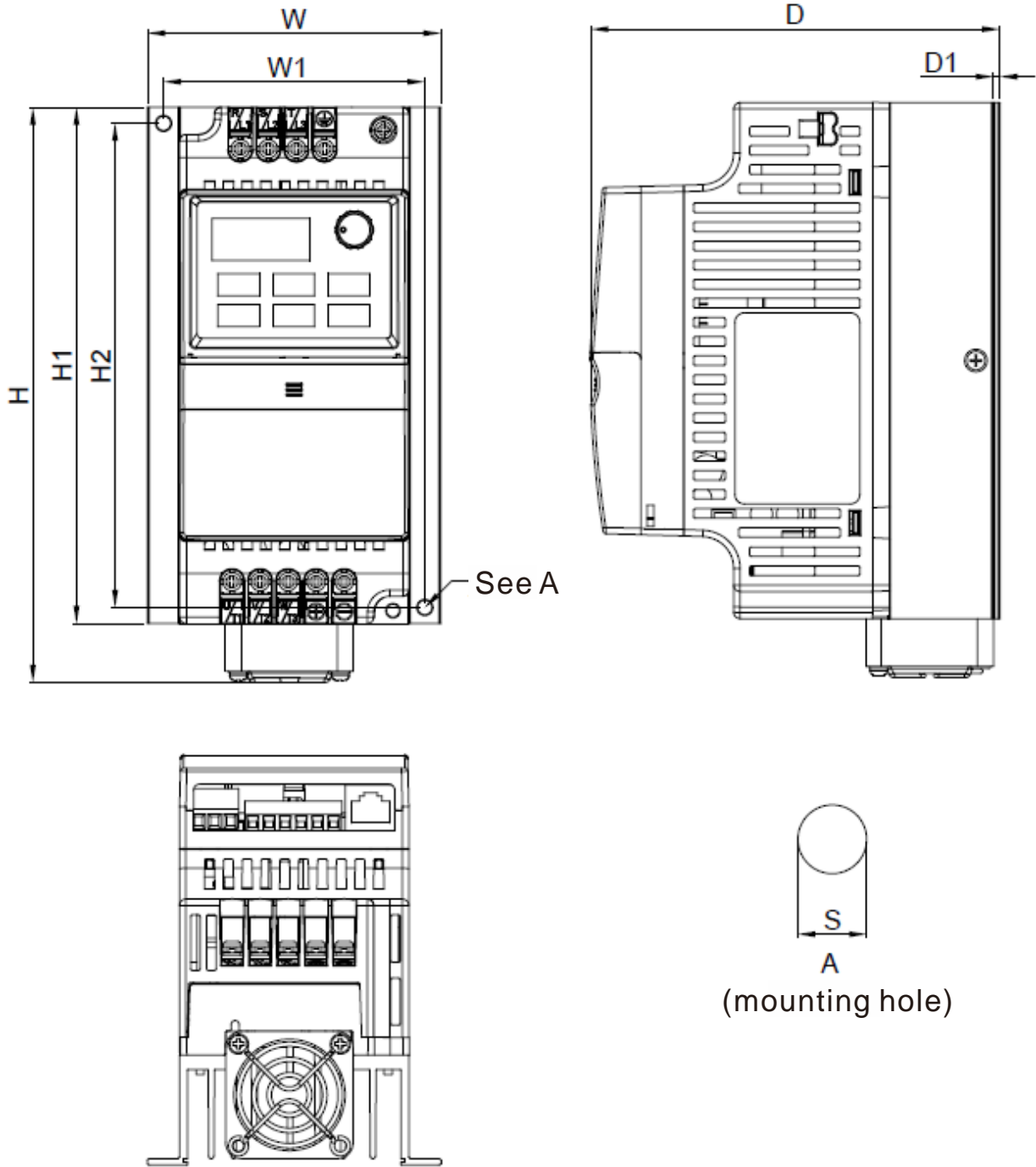

Unit: mm (inch)

Frame	W	W1	H	H1	H2	D	D1	S1
A2	92.0 (3.62)	82.0 (3.23)	180.5 (7.11)	162.0 (6.38)	152 (5.98)	128.7 (5.07)	2.0 (0.08)	5.4 (0.21)

Frame B

VFD015EL21W(-1), VFD022EL21W(-1), VFD022EL43W(-1), VFD040EL43W(-1), VFD055EL43W(-1)

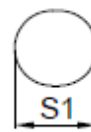
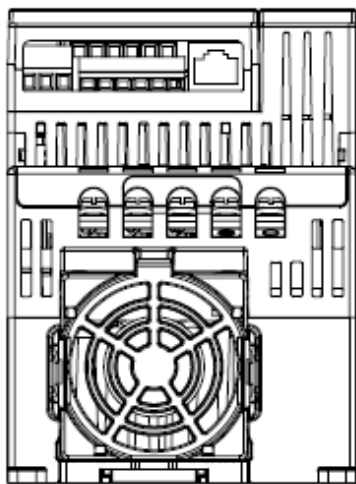
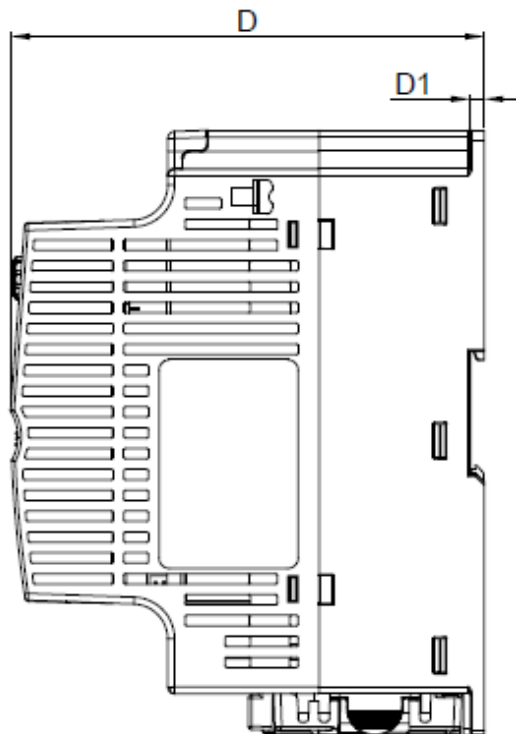
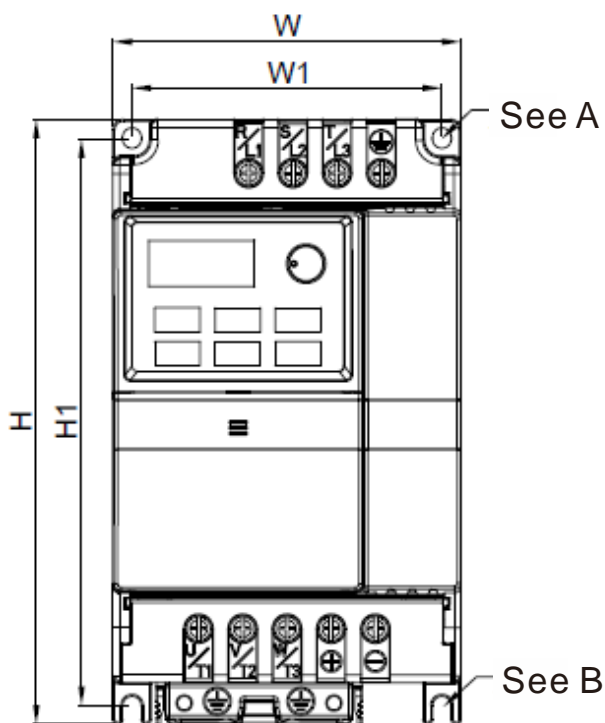

A
(mounting hole)

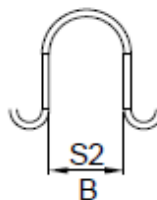

B
(mounting hole)

Unit: mm (inch)

Frame	W	W1	H	H1	D	D1	S1	S2
B	100.0 (3.94)	89.0 (3.50)	174.0 (6.86)	162.9 (6.42)	136.0 (5.36)	4.0 (0.16)	5.9 (0.23)	5.4 (0.21)

Chapter 1 Introduction | VFD-EL-W

[This page is intentionally left blank]

Chapter 2 Installation and Wiring

2-1 Wiring

2-2 External Wiring

2-3 Main Circuit

2-4 Control Terminals

2-5 NPN / PNP Mode

Chapter 2 Installation and Wiring | VFD-EL-W

After removing the covers of input/ output side terminals and control board terminals, verify the main circuit terminals and control circuit terminals are clear. Be sure to observe the following precautions when wiring.

**DANGER**

- ☑ Turn off the AC motor drive power before installing any wiring. A hazardous charge may still remain in the DC bus capacitors after the power has been turned off. For your safety, wait until the digital keypad indicator turns off and measure the DC voltage with the voltmeter. Make sure the voltage drops to a safe level $< 25 V_{DC}$ before wiring. Performing a wiring installation while voltage remains may cause sparks and short circuits.
- ☑ Only qualified personnel familiar with AC motor drives are allowed to do the wiring. Make sure the power is turned off before wiring to prevent electric shock.
- ☑ Make sure that power is only applied to the R/L1, S/L2, and T/L3 terminals. Failure to comply may result in damage to the equipment. The voltage and current should be in the range on the AC motor drive nameplate. (refer to Section 1-1 Receiving and Inspection for details)
- ☑ The grounding terminals must be well-grounded to prevent electric shock or fire accidents and to reduce noise interference.
- ☑ Make sure that you correctly tighten the main circuit terminal screws to prevent sparks that can be caused by screws loosened due to vibration.

**CAUTION**

- ☑ When wiring, choose wires that comply with local regulations for your safety.
- ☑ Check following items after finishing the wiring:
 1. Are all connections correct?
 2. Are there any loose wires?
 3. Are there any short circuits between the terminals or to ground?

2-1 Wiring

There are wirings for main circuits and control circuits. You must wire according to the following wiring diagrams.

230V One-phase

VFD002EL21W(-1), VFD004EL21W(-1), VFD007EL21W(-1), VFD015EL21W(-1), VFD022EL21W(-1)

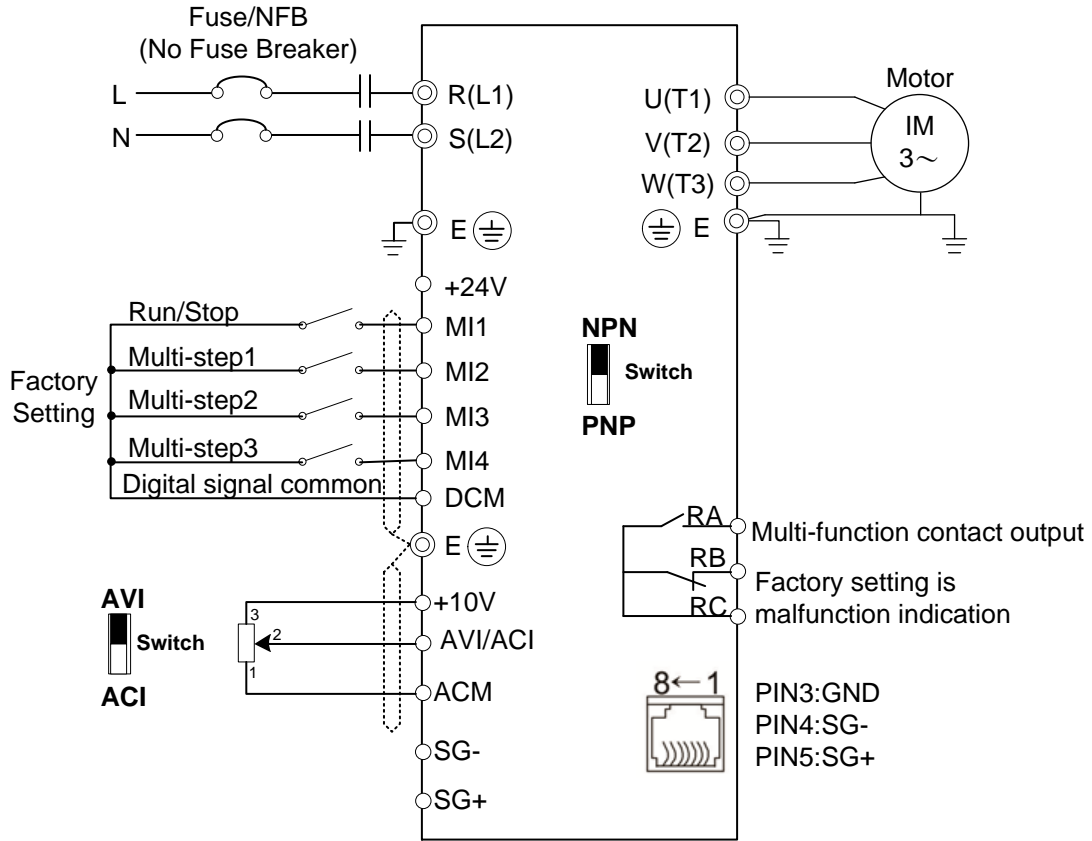

◎ Main circuit (power) terminals ○ Control circuit terminals ⌀ Shielded leads & cable

NOTE Terminal SG+,SG- are joined to PIN5,PIN4 of RJ45 Connector

Chapter 2 Installation and Wiring | VFD-EL-W

460V Three-phase

VFD004EL43W(-1), VFD007EL43W(-1), VFD015EL43W(-1), VFD022EL43W(-1), VFD040EL43W(-1), VFD055EL43W(-1)

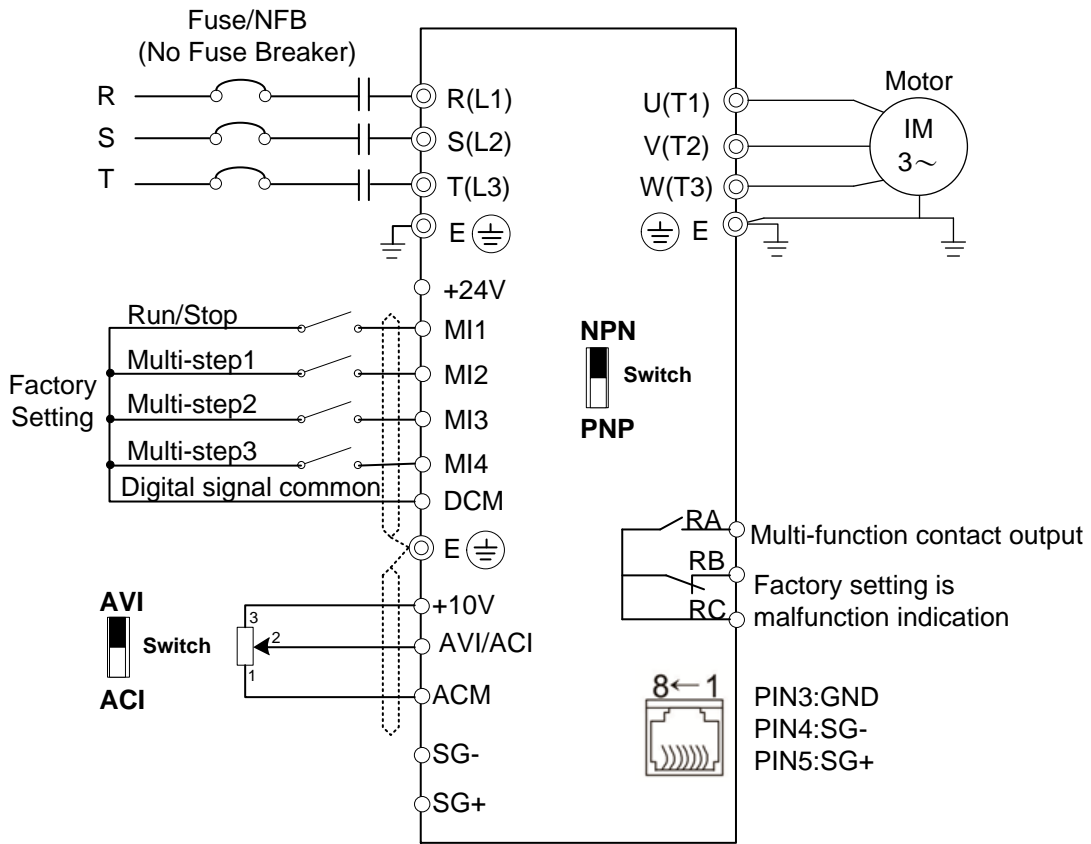

⊙ Main circuit (power) terminals ○ Control circuit terminals - - - - - Shielded leads & cable

NOTE Terminal SG+,SG- are joined to PIN5,PIN4 of RJ45 Connector

Wiring for NPN and PNP mode

● Internal power supply

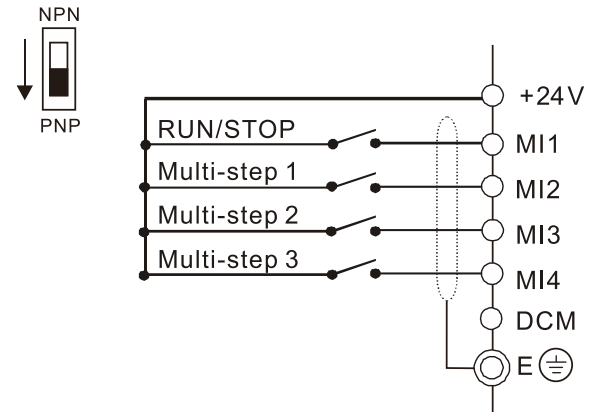
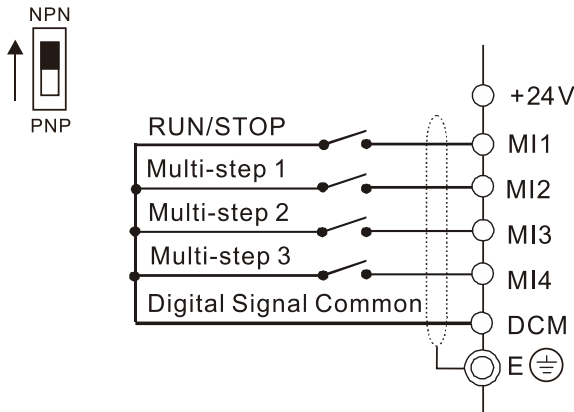

● External power supply

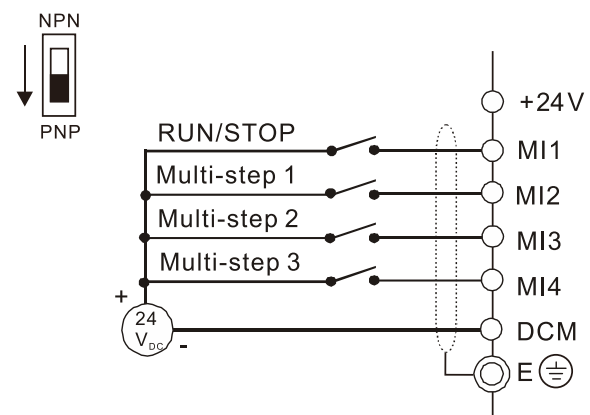
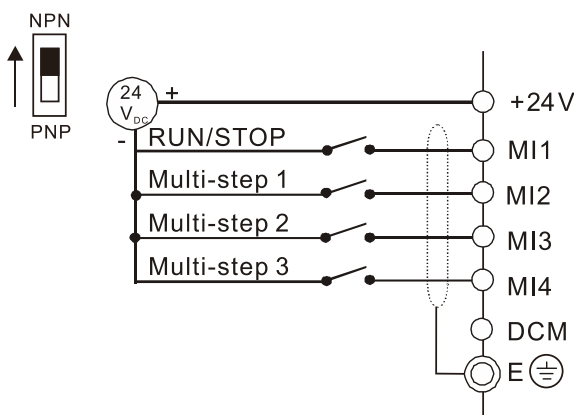

- ☑ Separate the main circuit and control circuit wiring to prevent erroneous actions.
- ☑ Use shielded wire for the control wiring and do not expose the peeled-off shield in front of the terminal.
- ☑ Use shielded wire or conduit for the power wiring and ground the two ends of the shielded wire or conduit.
- ☑ Damaged insulation of wiring may cause personal injury or damage to circuits and equipment if it comes in contact with high voltage.
- ☑ The AC motor drive, motor and wiring may cause interference. To prevent equipment damage, take care of interference between the surrounding sensors and the equipment.
- ☑ Connect the AC drive output terminals U/T1, V/T2, and W/T3 to the motor terminals U/T1, V/T2, and W/T3, respectively. To permanently reverse the direction of motor rotation, switch over any of the two motor leads.
- ☑ With long motor cables, high capacitive switching current peaks can cause over-current, high leakage current or lower current readout accuracy. To prevent this, the motor cable should be less than 20 m for 4.0 kW models and below. The cable should be less than 50 m for 5.5 kW models and above. For longer motor cables, use an AC output reactor.
- ☑ The AC motor drives, electric welding machines and the larger horsepower motors should be grounded separately.
- ☑ Use ground leads that comply with local regulations and keep them as short as possible.
- ☑ The VFD-EL-W series does not have a built-in brake unit and no support for external brake unit and brake resistor.
- ☑ When grounding, choose wires that comply with local regulations for your safety.

Chapter 2 Installation and Wiring | VFD-EL-W

- ☑ To prevent lightning strike and electric shock, the metal grounding wire of electrical equipment should be thick and short, and connected to the dedicated grounding terminal of the inverter system.
- ☑ You can install multiple VFD-EL-W units in one location. All the units should be grounded directly to a common ground terminal, as shown in the figure below. **Ensure that there are no ground loops.**

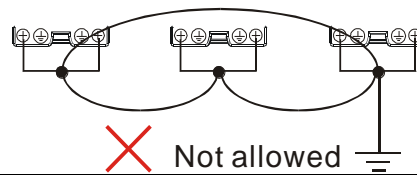
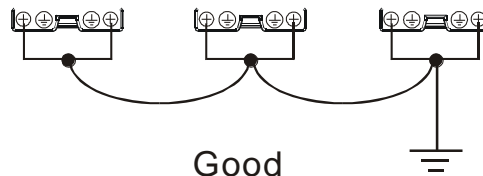
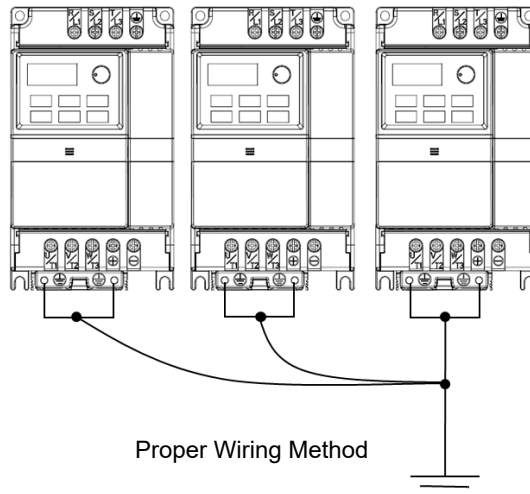

2-2 External Wiring

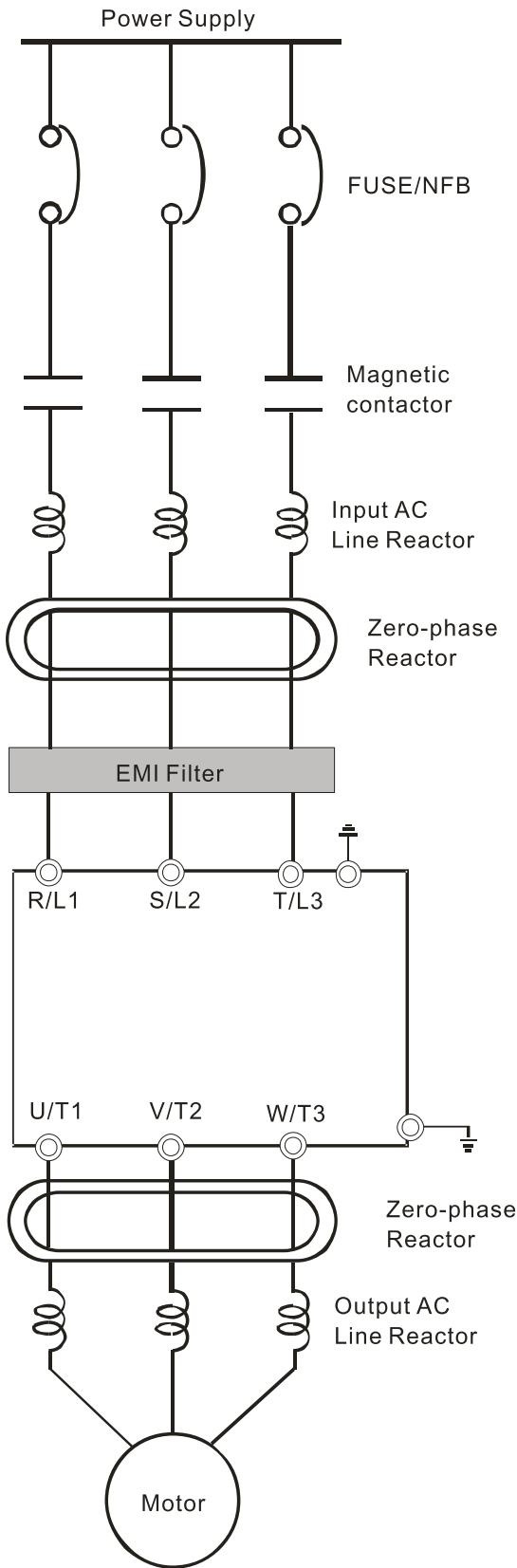

Items	Explanations
Power supply	Please follow the specific power supply requirements in Appendix A.
Fuse/NFB (optional)	There may be an inrush current during power-up. Please check the chart in Appendix B and select the correct fuse for the rated current. Use of an NFB is optional.
Magnetic contactor (optional)	Do not use a magnetic contactor as the I/O switch for the AC motor drive, as it will reduce the operating life of the AC drive.
Input AC Line Reactor (optional)	Use to improve the input power factor, reduce harmonics and provide protection from AC line disturbances (such as surges, switching spikes, short interruptions). Install an AC line reactor when the power supply capacity is 500 kVA or more, or advanced capacity is activated. The wiring distance should be $\leq 10m$. Refer to Appendix B for details.
Zero-phase Reactor (Ferrite Core Common Choke) (optional)	Use zero phase reactors to reduce radio noise, especially when audio equipment is installed near the inverter. They are effective for noise reduction on both the input and output sides. Attenuation quality is good for a wide range from the AM band to 10 MHz. Appendix B lists the specifications for zero-phase reactors (RF220X00A).
EMI filter	Use to reduce electromagnetic interference.
Output AC Line Reactor (optional)	Motor surge voltage amplitude depends on motor cable length. For applications with long motor cable (>20 m), install a reactor at the inverter output side.

Chapter 2 Installation and Wiring | VFD-EL-W

2-3 Main Circuit

2-3-1 Main Circuit Connection

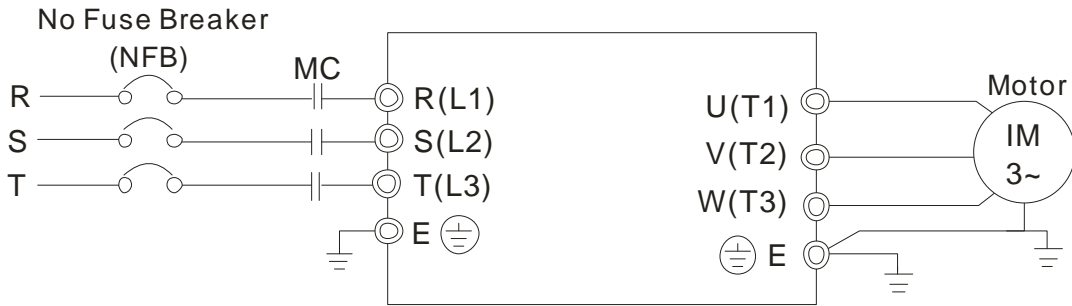

Terminal Symbol	Explanation of Terminal Function
R/L1, S/L2, T/L3	Mains input terminals (one-phase/ three-phase)
U/T1, V/T2, W/T3	Motor drive output terminals for connecting three-phase induction motor
⊕	Ground connection. Please comply with local regulations.



Mains power terminals (R/L1, S/L2, T/L3)

- Do NOT connect three-phase motor drives to single-phase AC power. There is no sequential order when connecting mains power terminals R/L1, S/L2, T/L3. Connect these terminals with a freely usable standard.
- Connect terminals (R/L1, S/L2, and T/L3) with a non-fuse breaker to three-phase AC power for circuit protection. It is recommended that you add a magnetic contactor (MC) in the power input wiring to cut off power quickly and reduce malfunction when activating the protection function for the AC motor drives. Both ends of the MC should have an R-C surge absorber.
- Make sure that you correctly tighten the main circuit terminal screws to prevent sparks caused by loosening screws due to vibration.
- Use voltage and current levels according to the specifications in Appendix A.
- When using a GFCI (Ground Fault Circuit Interrupter), select a current sensor with sensitivity of 200 mA or higher, and not less than 0.1 second operation time to avoid nuisance tripping. For specific GFCI of the AC motor drive, select a current sensor with sensitivity of 30 mA or higher.
- Do NOT run or stop AC motor drives by turning the power ON or OFF. Use the RUN or STOP command through the control terminals or a keypad. If you still need to run or stop the AC drives by turning the power ON or OFF, it is recommended to do so no more often than ONCE per hour.

Output terminals for main circuit (U, V, W)

- The default for the operation direction is running forward. The method to control the running direction is to set by the communication parameters. Refer to the Parameter Group 09 in Chapter 4 for details.

-
- | | |
|-------------------------------------|--|
| <input checked="" type="checkbox"/> | When it is necessary to install the filter at the output side of terminals U/T1, V/T2, W/T3 on the AC motor drive, use an inductance filter. Do not use phase-compensation capacitors or L-C (Inductance-Capacitance) or R-C (Resistance-Capacitance), unless approved by Delta. |
| <input checked="" type="checkbox"/> | DO NOT connect phase-compensation capacitors or surge absorbers at the output terminals of AC motor drives. |
| <input checked="" type="checkbox"/> | Use a well-insulated motor, suitable for inverter operation. |
-

Chapter 2 Installation and Wiring | VFD-EL-W

2-3-2 Main Circuit Terminals

Frame A1

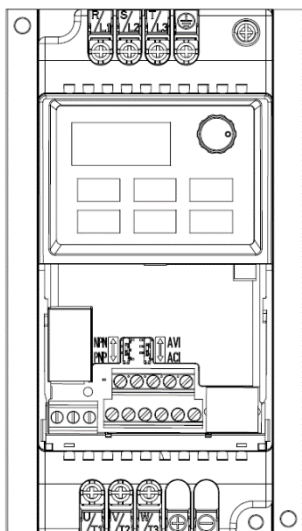

Frame A2

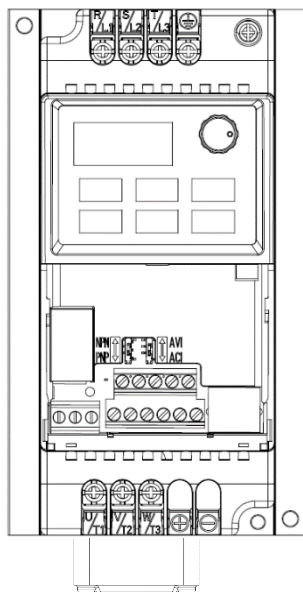

Frame B

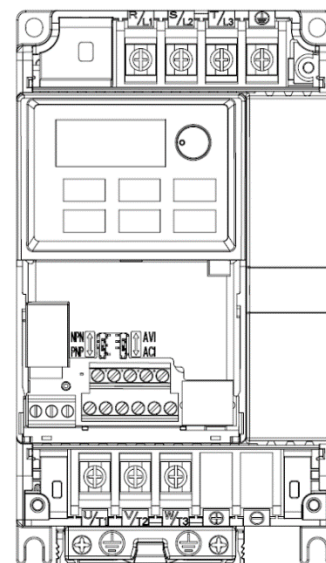

Frame	Model	Main Circuit Terminals R/L1, S/L2, T/L3, U/T1, V/T2, W/T3, ⊕		
		Maximum Wire Gauge	Minimum Wire Gauge	Screw Size Tightening Torque (±10%)
A1	VFD007EL21W(-1)	4 mm ² (12 AWG)	4 mm ² (12AWG)	M4 screw 15 kgf-cm (13 in-lbf) (1.47 Nm)
	VFD007EL43W(-1)		2.5 mm ² (14AWG)	
A2	VFD015EL43W(-1)			
B	VFD015EL21W(-1)	10 mm ² (8 AWG)	10 mm ² (8 AWG)	M4 screw 13 kgf-cm (11.4 in-lbf) (1.3 Nm)
	VFD022EL21W(-1)			
	VFD022EL43W(-1)			
	VFD040EL43W(-1)		2.5 mm ² (14 AWG)	
	VFD055EL43W(-1)			

NOTE:

- For installation at an ambient temperature of 50°C, select copper wires with temperature resistance of 75°C or 90°C. For installation at an ambient temperature over 50°C, select copper wires with temperature resistance of 90°C or above.
- For VFD007EL21W(-1) model: when install at Ta 40°C environment, use copper wires that are temperature resistance to 75°C or 90°C; when install at Ta 40°C above environment, use copper wires that are temperature resistance to 90°C or above.
- When installing VFDxxxEL21W(-1), use wires that have a voltage rating of 300 V_{AC} or above. When installing VFDxxxEL43W(-1), use wires that have a voltage rating of 600 V_{AC} or above.

2-4 Control Terminals

2-4-1 Control Terminals Description

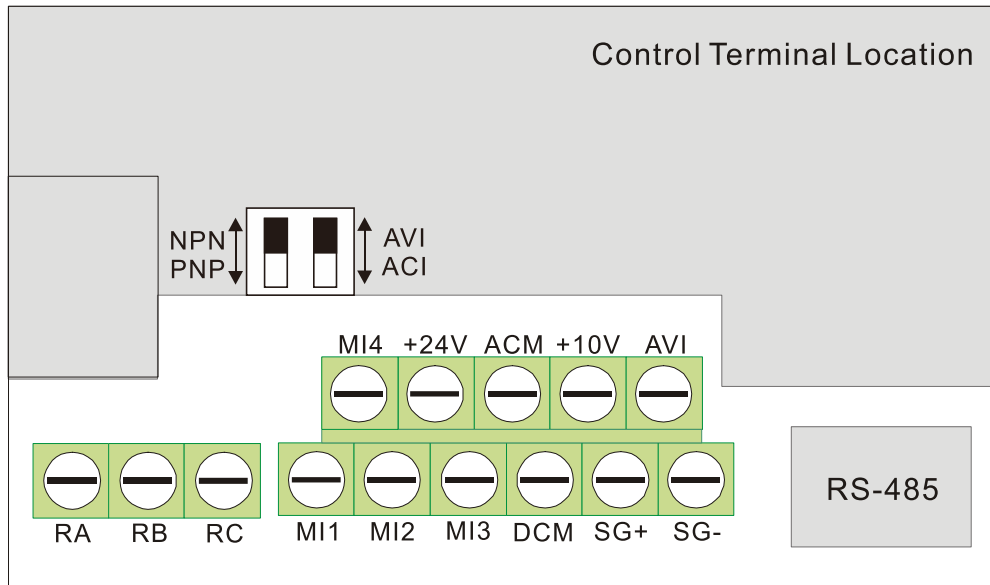

Terminal symbols and functions

Terminal Symbol	Terminal Function	Defaults (NPN mode) ON: Connect to DCM
MI1	Run-Stop Command	ON: Run in MI1 direction OFF: Stop acc. to Stop Method
MI2	Multi-function Input 2	Refer to Pr.04.06 to Pr.04.08 for programming the multi-function inputs. ON: the activation current is 5.5 mA. OFF: leakage current tolerance is 10 μ A.
MI3	Multi-function Input 3	
MI4	Multi-function Input 4	
+24V	Digital control signal common (Source)	The +24V power total output capacity: 60 mA 1. When using MI terminal, the current capacity required for the terminal operation should be deducted accordingly (6 mA for each MI terminal). 2. Do NOT use it for excessive loads to avoid damage to the internal circuit.
DCM	Digital Signal Common (Sink)	Common for multi-function input terminals.
SG+	Modbus RS-485	Internally connected to RJ45 terminal PIN5 and PIN4, providing flexible choice for users (only support one of them at one time).
SG-		
RA	Multi-function Relay Output (N.O.) a	Resistive Load: 5 A (N.O.) / 3 A (N.C.) 240 V _{AC}
RB	Multi-function Relay Output (N.C.) b	5 A (N.O.) / 3 A (N.C.) 24 V _{DC}

Chapter 2 Installation and Wiring | VFD-EL-W

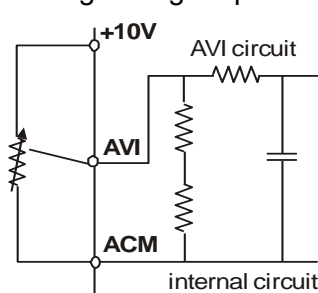
Terminal Symbol	Terminal Function	Defaults (NPN mode) ON: Connect to DCM
RC	Multi-function Relay Common	Inductive Load: 1.5 A (N.O.) / 0.5 A (N.C.) 240 V _{AC} 1.5 A (N.O.) / 0.5 A (N.C.) 24 V _{DC} Refer to Pr.03.00 for programming
+10V	Potentiometer Power Supply	+10 V _{DC} 3 mA (Variable resistor 3–5 kΩ)
AVI	Analog Voltage Input 	Impedance: 47 kΩ Resolution: 10 bits Range: 0–10 V _{DC} / 4–20 mA = 0–maximum output frequency (Pr.01.00) Selection: Pr.02.00, Pr.02.09, Pr.10.00 Setting: Pr.04.14–Pr.04.17
ACM	Analog Control Signal (Common)	Common for AVI

NOTE: Control signal wiring size: 18 AWG (0.75 mm²) with shielded wire.

Analog inputs (AVI, ACM)

- ☑ Analog input signals are easily affected by external noise. Use shielded wiring and keep it as short as possible (< 20 m) with proper grounding. If the noise is inductive, connecting the shield to the ACM terminal can cause improvement.
- ☑ If the analog input signals are affected by noise from the AC motor drive, connect a capacitor (0.1 μF and above) and a ferrite core as shown in the following diagrams:

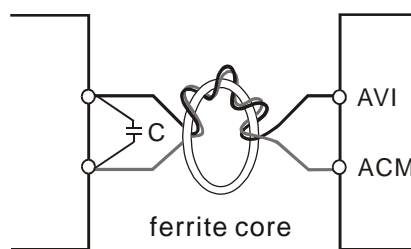

Wind each wire three times or more around the core

Digital inputs (MI1, MI2, MI3, DCM)

- ☑ When using contacts or switches to control the digital inputs, use high-quality components to avoid contact bounce.

2-4-2 Specification for the control terminals

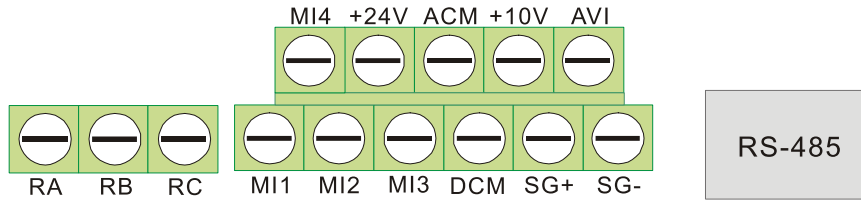

Frame	Model	Wire	Single Row Terminal Torque ($\pm 10\%$)	Double Row Terminal Torque ($\pm 10\%$)
A1	VFD007EL21W(-1)	16–24 AWG (1.3–0.2 mm ²)	4 kgf-cm (3.5 lbf-in) (0.4 N-m)	7 kgf-cm (6.2 lbf-in) (0.7 N-m)
	VFD007EL43W(-1)			
A2	VFD015EL43W(-1)			
B	VFD015EL21W(-1)			
	VFD022EL21W(-1)			
	VFD022EL43W(-1)			
	VFD040EL43W(-1)			
	VFD055EL43W(-1)			

Chapter 2 Installation and Wiring | VFD-EL-W

2-5 NPN / PNP Mode

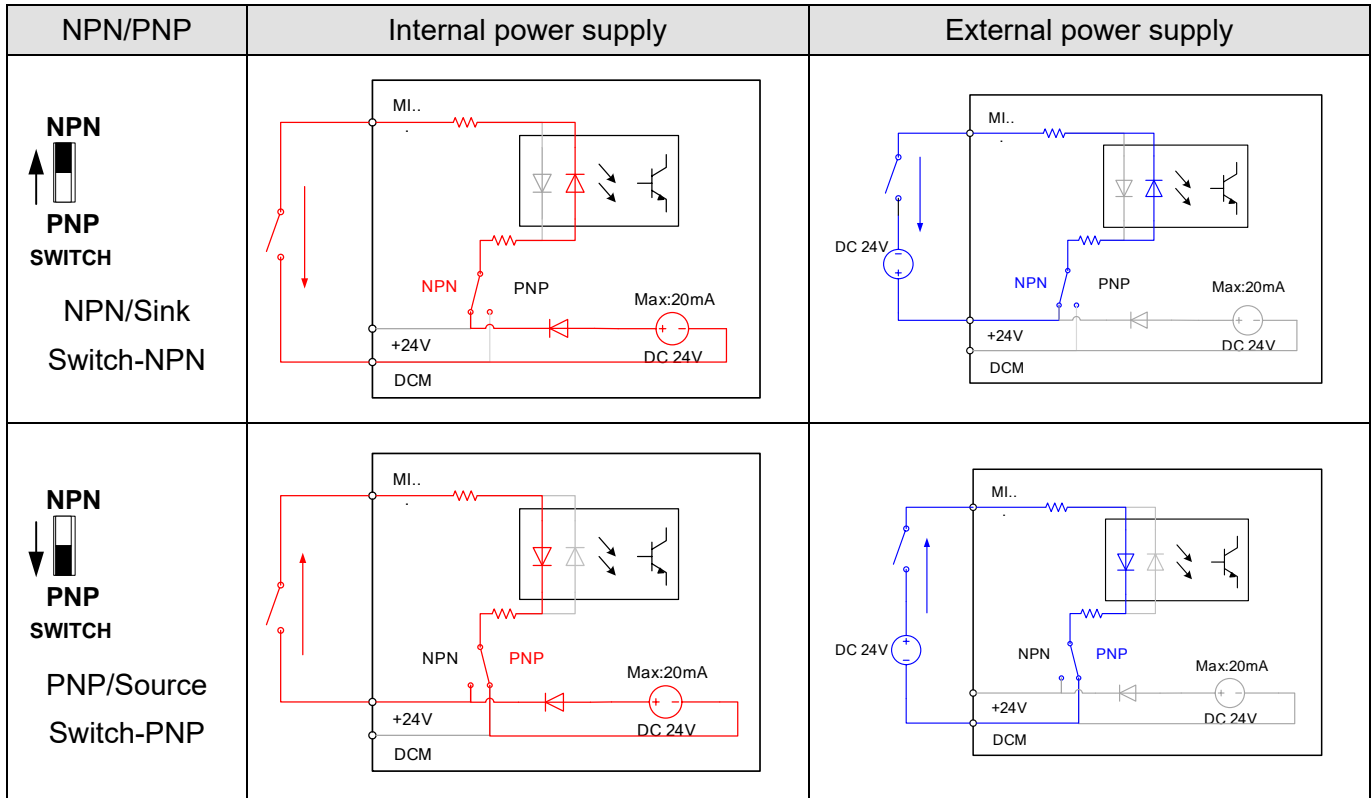
**NOTE:**

1. The +24V-DCM internal 24V power capacity is 60 mA. For the output capacity of other external loads, the current consumption of the corresponding number of MI terminals should be deducted (6 mA for each MI terminal).
2. For VFD007EL21W(-1) model, if you need to install fan kit, the fan power supply is powered by +24V-DCM. Except for the normal use of the MI terminal, do not use other external loads in the same time to prevent the +24V terminal from being overloaded and the drive damaged.

Chapter 3 Keypad and Start-up

3-1 Description of the Digital Keypad

3-2 Operation Method

3-3 Trial Run

Chapter 3 Keypad and Start-up | VFD-EL-W**CAUTION**

- Make sure that the wiring is correct. In particular, ensure that the output terminals U/T1, V/T2, W/T3 are NOT connected to power and that the drive is well grounded.
- Verify that no other equipment is connected to the AC motor drive.
- Do NOT operate the AC motor drive with wet hands.
- Please check if the digital keypad displays F60.0 or F50.0 is ON when power is applied.

**DANGER**

- Stop the motor when a fault occurs during running and refer to Chapter 6 Fault Code Information and Maintenance for solutions. DO NOT touch output terminals U, V, W when power is still applied to L1/R, L2/S, L3/T, even when the AC motor drive is stopped to prevent electric shock.

3-1 Description of the Digital Keypad

3-1-1 Digital Keypad Appearance

VFD-EL-W series operates the running and displays the functions by the digital keypad.



① Status Display

Displays the drive's current status: RUN, STOP, FWD, REV

② LED Display

Indicates frequency, current, voltage, running direction, user-defined units, faults, etc.

③ Potentiometer

Sets the master frequency

④ UP / DOWN Key













Selects parameters and sets / changes parameter settings

There are four LEDs on the keypad

- STOP: Lights when the drive stops.
- RUN: Lights when the motor is running.
- FWD: Lights when the motor is running forward.
- REV: Lights when the motor is running reverse.

Chapter 3 Keypad and Start-up | VFD-EL-W

3-1-2 Description of the Displayed Functions

Display Function	Description
 RUN ● STOP FWD ● REV ●	Displays current setting frequency of the AC motor drive.
 RUN ● STOP FWD ● REV ●	Displays the actual output frequency to the motor.
 RUN ● STOP FWD ● REV ●	Displays the user-defined unit (where $U = F \times Pr.00.05$)
 RUN ● STOP FWD ● REV ●	Displays the loading current.
 RUN ● STOP FWD ● REV ●	FWD command.
 RUN ● STOP FWD ● REV ●	REV command.
 RUN ● STOP FWD ● REV ●	The counter value (C).
 RUN ● STOP FWD ● REV ●	Displays the selected parameter.
 RUN ● STOP FWD ● REV ●	Displays the actual stored value of the selected parameter.
 RUN ● STOP FWD ● REV ●	Displays the external fault.
 RUN ● STOP FWD ● REV ●	Displays "End" for approximately one second (as shown in the left figure) if the data has been accepted and automatically stored in the register.
 RUN ● STOP FWD ● REV ●	Displays if the setting data is not accepted or data value exceeds the allowed range.

3-1-3 Keypad Operation Process

Setting Mode

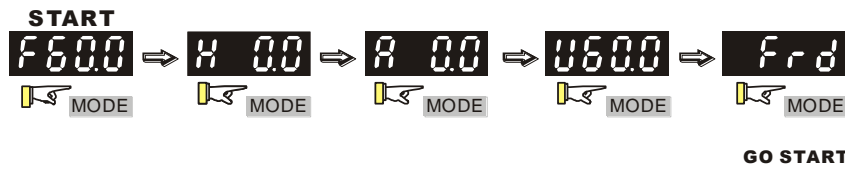

NOTE: In the selection mode, press to set the parameters.

Setting parameters



NOTE :In the parameter setting mode, you can press to return the selecting mode.

To shift data



Setting direction (When operation source is digital keypad)

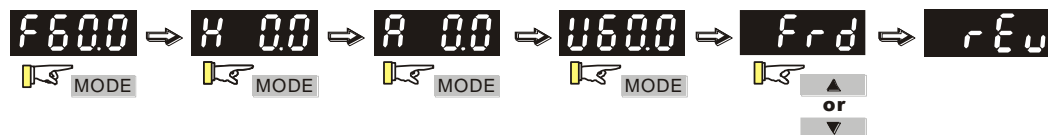

3-1-4 Reference Table for the Seven-segment LED Display of the Digital Keypad

Digit	0	1	2	3	4	5	6	7	8	9
Led Display	0	1	2	3	4	5	6	7	8	9
English Alphabet	A	b	Cc	d	E	F	G	Hh	li	Jj
Led Display	A	b	Cc	d	E	F	G	Hh	li	Jj
English Alphabet	K	L	n	Oo	P	q	r	S	Tt	U
Led Display	K	L	n	Oo	P	q	r	S	Tt	U
English Alphabet	v	Y	Z							
Led Display	v	Y	Z							

Chapter 3 Keypad and Start-up | VFD-EL-W

3-2 Operation Method

You can set Pr.02.01 to select the operation method to be through the digital keypad, RS-485 communication or control terminals.

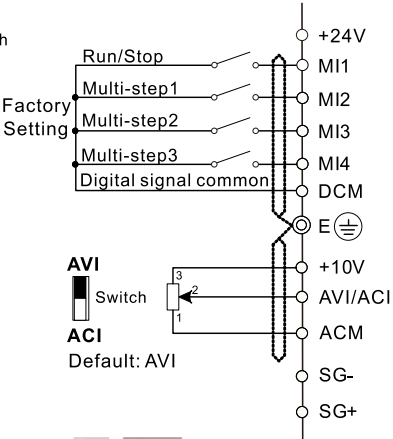

Operation Method	Frequency Source	Operation Command Source
Operate through communication	When using communication from the PC, use an IFD6500 / IFD6530 or IFD8500 converter to connect the drive to the PC. Refer to the communication address 2000H and 2101H setting for details.	
Operate through the digital keypad	 <p style="text-align: right;">Figure 3-1</p>	
	Set the frequency source through the ▲ ▼ keys, as shown in Figure 3-1.	Set the operation command source through the RUN, STOP / RESET keys, as shown in Figure 3-1.
Operate through external signals	<div style="display: flex; align-items: center;"> <div style="margin-right: 20px;"> <p>Default: NPN</p> <p>NPN</p> <p>PNP</p> <p>Switch</p> </div> <div>  </div> </div> <p style="text-align: center;">NOTE Terminal SG+, SG- are joined to PIN5, PIN4 of RJ45 connector</p> <p style="text-align: right;">Figure 3-2</p>	
	<p>MI3-DCM (Set Pr.04.05 = d10)</p> <p>MI4-DCM (Set Pr.04.06 = d11)</p>	<p>Set MI1-DCM as Run / Stop.</p> <p>Refer to the parameter descriptions in Chapter 04 for details of FWD/REV operations.</p>

3-3 Trial Run

The default for the operation source is the digital keypad. The setting methods are as follows:

- ☑ After applying power, verify that the LED display shows F 60.0 Hz.
- ☑ Press  key to set the frequency to be around 5 Hz. (Refer to Figure 3-1)
- ☑ If you want to change FWD to REV, press MODE to find the FWD function, then press the UP or DOWN key to locate the REV function to finish the direction change.
- ☑ Check following items:
 1. Check if the motor rotation direction is correct.
 2. Check if the motor runs steadily without abnormal noise and vibration.
 3. Check if acceleration and deceleration are smooth.

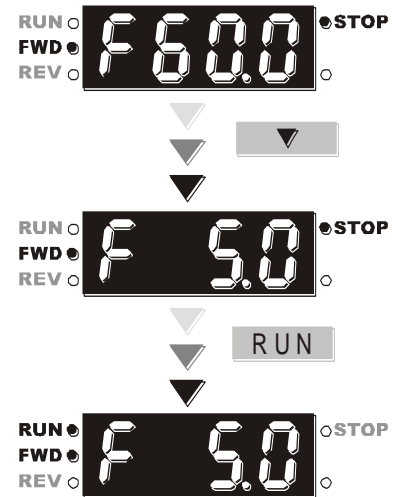

If the results of trial run are normal, increase the operating frequency to continue the trial run. If the trial run still goes normally, then you can start the formal run.

Motor operating direction

When the AC drive output terminals U/T1, V/T2 and W/T3 are connected to the motor terminals U/T1, V/T2 and W/T3 respectively, the FWD LED indicator on the digital keypad is ON. This means the AC motor drive executes running forward, and the motor rotates as the figure below shows. On the contrary, when the REV LED indicator lights, the AC motor drive executes running in reverse, and the motor rotates in an opposite direction as the figure below shows. If the AC motor drive executes running forward but the motor rotates in a reverse direction, exchange any two of the U/T1, V/T2 and W/T3 motor terminals.

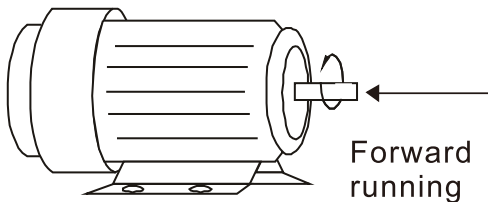

Figure 3-3

Chapter 3 Keypad and Start-up | VFD-EL-W

[This page is intentionally left blank]

Chapter 4 Parameters

- 4-1 Summary of Parameter Settings
- 4-2 Parameter Settings for Applications
- 4-3 Description of Parameter Settings
- 4-4 Adjustment and Application

Chapter 4 Parameters | VFD-EL-W

The VFD-EL-W parameters are divided into 11 groups by property for easy setting. In most applications, users can complete all parameters settings before starting-up according to the relevant parameters settings in the parameter group. The 11 parameter groups are as following:

- 00: User Parameters
- 01: Basic Parameters
- 02: Operation Method Parameters
- 03: Output Function Parameters
- 04: Input Function Parameters
- 05: Multi-Step Speed Parameters
- 06: Protection Parameters
- 07: Motor Parameters
- 08: Special Parameters
- 09: Communication Parameters
- 10: PID Control Parameters

4-1 Summary of Parameter Settings

NOTE: Parameters/ options marked in **Gray** are applied only for V1.00_5.5 kW models.

00 User Parameters

✎ You can set this parameter during operation.

Pr.	Parameter Name	Setting Range	Default
00.00	AC Motor Drive Identity Code	0: 230V, 0.25 HP 2: 230V, 0.5 HP 3: 460V, 0.5 HP 4: 230V, 1 HP 5: 460V, 1 HP 6: 230V, 2 HP 7: 460V, 2 HP 8: 230V, 3 HP 9: 460V, 3 HP 11: 460V, 5.5 HP 13: 460V, 7.5 HP	Read only
00.01	AC Motor Drive Rated Current Display	Display by models	Read only
00.02	Parameter Reset	0: Parameter can be read/written 1: All parameters are read only 7: Keypad and frequency setting knob locked 8: Keypad lock 9: Reset all parameters to defaults (50 Hz, 230V/400V or 220V/380V depends on Pr.00.12) 10: Reset all parameters to defaults (60 Hz, 220V/440V)	0
✎ 00.03	Start-up Display	0: F (frequency command) 1: H (output frequency) 2: A (output current) 3: U (user-defined, see Pr.00.04) 4: FWD/REV command	0
✎ 00.04	Content of Multi-function Display (User-Defined)	0: Display the content of user-defined unit 1: Display counter value (c) 2: Display the status of multi-function input terminal (d) 3: Display the drive's DC bus voltage (u) 4: Display the drive's output voltage (E) 5: Display PID analog feedback signal (b) 6: Display the drive's power factor angle (n) 7: Display the drive's output power (P)	0

Chapter 4 Parameters | VFD-EL-W

Pr.	Parameter Name	Setting Range	Default
		8: Display the setting value and the feedback of PID control (P) 9: Display AVI analog input terminal signal (V) (I) 10: Display ACI analog input terminal signal (mA/V) (i) 11: Display IGBT temperature (°C) (h)	
00.05	User-Defined Coefficient K	0.1–160.0	1.0
00.06	Firmware Version	Read only	###
00.07	Software Version (Date)	Read only	Read only
00.08	Parameter Protection Password Input	0–9999 0–4: the number of password attempts allowed	0
00.09	Parameter Protection Password Setting	0–9999 0: No password protection or password is entered correctly (Pr.00.08) 1: Password has been set	0
00.10	Control Method	0: V/F voltage frequency control 1: Vector control	0
00.11	Reserved		
00.12	50 Hz Power System Base Voltage Setting	0: 230V/ 400V 1: 220V/ 380V	0
00.13	User-Defined Value (corresponds to Max. operation frequency Pr.01.00)	0–9999	0
00.14	Decimal Places for User-Defined Value	0–3	0
00.15	Output Phase Order Selection	0: Standard 1: Reverse the operation direction	0
00.16	Prohibit Write EEPROM Function	0: Disable 1: Enable, control via MI terminal 2: Enable, MI terminal is invalid	0

01 Basic Parameters

✎ You can set this parameter during operation.

Pr.	Parameter Name	Setting Range	Default
01.00	Max. Operation Frequency	50.00–400.0 Hz	60.00/ 50.00
01.01	Motor Rated Frequency	0.10–400.0 Hz	60.00/ 50.00
01.02	Motor Rated Voltage	230V models: 0.1–255.0 V	220.0/ 230.0
		460V models: 0.1–510.0 V	380.0/ 400.0
01.03	Mid-Point Frequency Setting	0.10–400.0 Hz	1.50
01.04	Mid-Point Voltage Setting	230V models: 0.1–255.0 V 460V models: 0.1–510.0 V	10.0 20.0
01.05	Min. Output Frequency Setting (Hz)	0.10–400.0 Hz	1.50
01.06	Min. Output Voltage Setting	230V models: 0.1–255.0 V 460V models: 0.1–510.0 V	10.0 20.0
01.07	Output Frequency Upper Limit	0.1–120.0%	110.0
01.08	Output Frequency Lower Limit	0.0–100.0%	0.0
✎ 01.09	Acceleration Time 1	0.1–600.0 sec./ 0.01–600.00 sec.	10.0
✎ 01.10	Deceleration Time 1	0.1–600.0 sec./ 0.01–600.00 sec.	10.0
✎ 01.11	Acceleration Time 2	0.1–600.0 sec./ 0.01–600.00 sec.	10.0
✎ 01.12	Deceleration Time 2	0.1–600.0 sec./ 0.01–600.00 sec.	10.0
✎ 01.13	JOG Acceleration Time	0.1–600.0 sec./ 0.01–600.00 sec.	1.0
✎ 01.14	JOG Deceleration Time	0.1–600.0 sec./ 0.01–600.00 sec.	1.0
✎ 01.15	JOG Frequency Setting	0.10–400.0 Hz	6.00
01.16	Auto-Acceleration / Auto-Deceleration Setting	0: Linear acceleration and deceleration 1: Auto-acceleration and linear deceleration 2: Linear acceleration and auto-deceleration 3: Auto-acceleration and auto-deceleration (set by loads) 4: Auto-acceleration and auto-deceleration (set by acceleration/ deceleration time setting)	0
01.17	S-Curve Acceleration Time Setting	0.0–10.0 sec./ 0.00–10.00 sec.	0.0

Chapter 4 Parameters | VFD-EL-W

Pr.	Parameter Name	Setting Range	Default
01.18	S-Curve Deceleration Time Setting	0.0–10.0 sec./ 0.00–10.00 sec.	0.0
01.19	Time Unit for Acceleration and Deceleration	0: Unit 0.1 sec. 1: Unit 0.01 sec.	0
↗ 01.20	Simple Positioning Stop Frequency 0	0.00–400.00 Hz	0.00
↗ 01.21	Simple Positioning Stop Frequency 1		5.00
↗ 01.22	Simple Positioning Stop Frequency 2		10.00
↗ 01.23	Simple Positioning Stop Frequency 3		20.00
↗ 01.24	Simple Positioning Stop Frequency 4		30.00
↗ 01.25	Simple Positioning Stop Frequency 5		40.00
↗ 01.26	Simple Positioning Stop Frequency 6		50.00
↗ 01.27	Simple Positioning Stop Frequency 7		60.00
↗ 01.28	Simple Positioning Stop Delay Time 0		0.00–600.00 sec.
↗ 01.29	Simple Positioning Stop Delay Time 1	0.00	
↗ 01.30	Simple Positioning Stop Delay Time 2	0.00	
↗ 01.31	Simple Positioning Stop Delay Time 3	0.00	
↗ 01.32	Simple Positioning Stop Delay Time 4	0.00	
↗ 01.33	Simple Positioning Stop Delay Time 5	0.00	
↗ 01.34	Simple Positioning Stop Delay Time 6	0.00	
↗ 01.35	Simple Positioning Stop Delay Time 7	0.00	

02 Operation Method Parameters

✎ You can set this parameter during operation.

Pr.	Parameter Name	Setting Range	Default
✎ 02.00	First Master Frequency Command Source	0: Digital keypad input or external terminals (up/down function) 1: External terminal AVI analog input DC 0–10V 2: External terminal ACI analog signal DC 4–20 mA 3: RS-485 communication input 4: Digital keypad potentiometer knob	0
✎ 02.01	Operation Command Source	0: Digital keypad 1: External terminals, STOP key is valid 2: External terminals, STOP key is invalid 3: RS-485 communication, STOP key is valid 4: RS-485 communication, STOP key is invalid	0
02.02	Stop Method	0: Ramp to stop; E.F.: Coast to stop 1: Coast to stop; E.F.: Coast to stop 2: Ramp to stop; E.F.: Ramp to stop 3: Coast to stop; E.F.: Ramp to stop 4: Simple positioning stop; E.F.: Coast to stop	0
02.03	PWM Carrier Frequency Selection	2–12 kHz	8
02.04	Motor Direction Control	0: Reverse enable 1: Disable reverse 2: Disable forward	0
02.05	Power-On and Run Command Source Changes Motor Drive Operation Control (external terminal only)	0: Operates when power-on, remains current running status when the operation command is changed 1: Do not run when power-on, remains current running status when the operation command is changed 2: Operates when power-on, runs according to the new operation command immediately 3: Do not run when power-on, runs according to the new operation command immediately 4: Runs when reset or power-on, changes operation command according to the external terminal status when the command source is 2-wire external terminal	1
02.06	ACI Loss	0: Decelerates to 0 Hz 1: Stop immediately and display AErr 2: Continue operation at the last frequency	1

Chapter 4 Parameters | VFD-EL-W

Pr.	Parameter Name	Setting Range	Default
		3: Operates at the frequency of Pr.02.11	
02.07	External Terminal Up/Down Key Mode Selection	0: By Up/ Down key 1: By acceleration/ deceleration time 2: By constant speed (Pr.02.08) 3: By pulse (Pr.02.08)	0
02.08	External Terminal Speed of the Up/ Down Key	0.01–10.00 Hz/2ms	0.01
02.09	Second Master Frequency Command Source	0: Digital keypad input or external terminals (up/down function) 1: External terminal AVI analog input DC 0–10 V 2: External terminal ACI analog signal DC 4–20 mA 3: RS-485 communication input 4: Digital keypad potentiometer knob	0
02.10	First / Second Master Frequency Command Combination	0: First master frequency command only 1: First master frequency command + second master frequency command 2: First master frequency command - second master frequency command	0
02.11	Keypad Frequency Command	0.00–400.0 Hz	60.00
02.12	Communication Frequency Command	0.00–400.0 Hz	60.00
02.13	Frequency Command Saving Mode	0: Save the frequency before power-off 1: Only save the keypad frequency command before power-off 2: Only save the communication frequency command before power-off	0
02.14	Initial Frequency Command Mode at Stop	0: Use current Frequency command 1: Use zero Frequency command 2: Refer to Pr.02.15 to set up	0
02.15	Initial Frequency Command Setting at Stop	0.00–400.0 Hz	60.00
02.16	Frequency Command Source Display	1: bit0 = 1: First frequency command source (Pr.02.00) 2: bit1 = 1: Second frequency command source (Pr.02.09) 4: bit2 = 1: Set by external MI terminal	Read only
02.17	Operation Command Source Display	1: bit0 = 1: Digital keypad 2: bit1 = 1: RS-485 4: bit2 = 1: External terminals	Read only

Pr.	Parameter Name	Setting Range	Default
		8: bit3 = 1: External MI terminals	
02.18	User-defined Value Setting	0–Pr.00.13	0
02.19	User-defined Value	0–9999	Read only

03 Output Function Parameters

✈ You can set this parameter during operation.

Pr.	Parameter Name	Setting Range	Default
03.00	Multi-Function Output Relay	0: No function 1: Indication during RUN 2: Master frequency reached 3: Indication at zero speed 4: Over-torque detection 5: Base Block (B.B) indication 6: Low-voltage indication 7: Operation mode indication 8: Fault indication 9: Desired frequency reached 10: Terminal count value reached 11: Preliminary count value reached 12: Over-voltage stall prevention 13: Over-current stall prevention 14: IGBT overheating (85°C ON, 80°C OFF) 15: Over-voltage 16: PID feedback error 17: Forward command 18: Reverse command 19: Zero speed (including STOP) 20: Warning indication 21: Mechanical brake control (use with Pr.03.11 and Pr.03.12) 22: Drive is ready 23: Indication of multi-pump system error (only Master)	8
03.01	Reserved		
03.02	Desired Frequency Reached	0.00–400.0 Hz	0.00
03.03	Reserved		
03.04	Reserved		
03.05	Count Value Reached	0–9999	0
03.06	Preliminary Count Value Reached	0–9999	0
03.07	EF Activates when the Terminal Count Value Reached	0: Terminal count value reached, no EF displays 1: Terminal count value reached, EF activates	0

Pr.	Parameter Name	Setting Range	Default
03.08	Fan Cooling Control	0: Fan is always ON 1: Fan is OFF after the AC motor drive stops for one minute. 2: Fan is ON when the AC motor drive runs; fan is OFF when the AC motor drive stops 3: Fan turns ON when temperature (IGBT) reaches (60°C ON, 40°C OFF) 4: Fan is ON when the AC motor drive runs; fan is OFF when the AC motor drive stops. Fan is in stand-by mode at zero speed.	0 (For fan cooling models only)
03.09	Reserved		
03.10	Reserved		
03.11	Mechanical Brake Release Frequency	0.00–20.00 Hz	0.00
03.12	Mechanical Brake Active Frequency	0.00–20.00 Hz	0.00
03.13	Display the Status of Multi-function Output Terminal	Refer to Description of Parameter Settings	Read only
03.14	Reserved		

04 Input Function Parameters

✎ You can set this parameter during operation.

Pr.	Parameter Name	Setting Range	Default
✎ 04.00	Keypad Potentiometer Bias	0.0–100.0%	0.0
✎ 04.01	Keypad Potentiometer Bias Direction	0: Positive bias 1: Negative bias	0
✎ 04.02	Keypad Potentiometer Gain	0.1–200.0%	100.0
04.03	Keypad Potentiometer Negative Bias with Reverse Motion	0: Positive bias only 1: Negative bias with reverse command	0
04.04	MI Terminal Start/ Stop Method and Multi-Function Input Selection	Mode 1 (Pr.04.19 = 0) 0: MI1 activates (FWD) / Stop Mode 2 (Pr.04.19 = 1) 0: Two-wire (1) MI1, MI2 1: Two-wire (2) MI1, MI2 3: Three-wire MI1, MI2 and MI3	0
04.05	Reserved	0: No function	
04.06	Start/ Stop or Multi-Function Input Command 1 (MI2)	1: Multi-step speed command 1 2: Multi-step speed command 2	1
04.07	Start/ Stop or Multi-Function Input Command 2 (MI3)	3: Multi-step speed command 3 4: Reserved	2
04.08	Multi-Function Input Command 3 (MI4)	5: Reset 6: Acceleration / deceleration speed inhibit	3
		7: 1st and 2nd acceleration / deceleration time selection 8: JOG operation 9: External B.B. input 10: Frequency up command 11: Frequency down command 12: Counter triggered signal input 13: Clear the counter 14: E.F. external fault 15: Disable PID function 16: Output stop 17: Parameter lock 18: Operation command selection: External terminals 19: Operation command selection: Digital keypad 20: Operation command selection: Communication control 21: FWD / REV	

Pr.	Parameter Name	Setting Range	Default
		22: Second frequency command source 23: Simple positioning FWD stop limit 24: Simple positioning REV stop limit 25: Multi-pump manual/ auto switch 29: Prohibit write EEPROM	
04.09	Multi-Function Input Contact Selection (N.O./ N.C.)	0–63	0
04.10	Digital Terminal Input Response Time	1–20 (*2ms)	1
↗ 04.11	Minimum AVI Input Voltage	0.0–10.0 V	0.0
↗ 04.12	Minimum AVI Input Frequency	0.0–100.0% Fmax	0.0
↗ 04.13	Maximum AVI Input Voltage	0.0–10.0 V	10.0
↗ 04.14	Maximum AVI Input Frequency	0.0–100.0% Fmax	100.0
↗ 04.15	Minimum ACI Input Current	0.0–20.0 mA	4.0
↗ 04.16	Minimum ACI Input Frequency	0.0–100.0% Fmax	0.0
↗ 04.17	Maximum ACI Input Current	0.0–20.0 mA	20.0
↗ 04.18	Maximum ACI Input Frequency	0.0–100.0% Fmax	100.0
04.19	MI Terminal Control Mode Selection	0: Mode 1, single-wire start/ stop 1: Mode 2, two-wire/ three-wire start/ stop	0
04.20 – 04.25	Reserved		
04.26	Display the Status of Multi-function Input Terminal	Refer to Description of Parameter Settings	Read only
↗ 04.27	Internal/ External Multi-Function Input Terminal Selection	0–63	0
↗ 04.28	Internal Multi-Function Input Terminal Setting	0–63	0

05 Multi-Step Speed Parameters

✎ You can set this parameter during operation.

Pr.	Parameter Name	Setting Range	Default
✎ 05.00	1 st Step Speed Frequency	0.00–400.0 Hz	0.00
✎ 05.01	2 nd Step Speed Frequency	0.00–400.0 Hz	0.00
✎ 05.02	3 rd Step Speed Frequency	0.00–400.0 Hz	0.00
✎ 05.03	4 th Step Speed Frequency	0.00–400.0 Hz	0.00
✎ 05.04	5 th Step Speed Frequency	0.00–400.0 Hz	0.00
✎ 05.05	6 th Step Speed Frequency	0.00–400.0 Hz	0.00
✎ 05.06	7 th Step Speed Frequency	0.00–400.0 Hz	0.00

06 Protection Parameters

✎ You can set this parameter during operation.

Pr.	Parameter Name	Setting Range	Default
06.00	Over-Voltage Stall Prevention	0: Disable 230V models: 330.0–410.0 V 460V models: 660.0–820.0 V	390.0 780.0
✎ 06.01	Over-Current Stall Prevention during Acceleration	20–250% (0: Disable)	170
✎ 06.02	Over-Current Stall Prevention during Operation	20–250% (0: Disable)	170
06.03	Over-Torque Detection Selection	0: No function 1: After over-torque detection during constant speed operation, continues operation until oL1 or oL protection activate 2: After over-torque detection during constant speed operation, stops and shows oL2 fault 3: After over-torque detection during acceleration and constant speed operation, continues operation until oL1 protection activates 4: After over-torque detection during acceleration and constant speed operation, stops and shows oL2 fault	0
✎ 06.04	Over-Torque Detection Level	10–200%	150
06.05	Over-Torque Detection Time	0.1–60.0 sec.	0.1
06.06	Electronic Thermal Relay Selection	0: Standard motor 1: Inverter Motor 2: Disabled	2
06.07	Electronic Thermal Relay Action Time	30–600 sec.	60
06.08	Fault Record 1	0: No fault record	0
06.09	Fault Record 2	1: Over-current (oc)	0
06.10	Fault Record 3	2: Over-voltage (ov)	0
06.11	Fault Record 4	3: IGBT over-heat (oH1)	0
06.12	Fault Record 5	4: Reserved	0
06.21	Fault Record 6	5: Drive over-load (oL)	0
06.22	Fault Record 7	6: Electronics thermal relay 1 protection (oL1)	0
06.23	Fault Record 8	7: Motor overload (oL2)	0

Chapter 4 Parameters | VFD-EL-W

Pr.	Parameter Name	Setting Range	Default
06.24	Fault Record 9	8: External fault (EF)	0
06.25	Fault Record 10	9: Over-current during acceleration (ocA)	0
		10: Over-current during deceleration (ocd)	
		11: Over-current at constant speed (ocn)	
		12: Reserved	
		13: Reserved	
		14: Phase loss (PHL)	
		15: Reserved	
		16: Auto-acceleration/ auto-deceleration fail (cFA)	
		17: Software or password protection (codE)	
		18: Write error (cF1.0)	
		19: Read error (cF2.0)	
		20: Protection circuit error (HPF1)	
		21: Protection circuit error (HPF2)	
		22: Reserved	
		23: Protection circuit error (HPF4)	
		24: U-phase hardware error (cF3.0)	
		25: V-phase hardware error (cF3.1)	
		26: W-phase hardware error (cF3.2)	
		27: DC bus hardware error (cF3.3)	
		28: OH1 hardware error (cF3.4)	
		29: Reserved	
		30: Reserved	
		31: Reserved	
		32: Analog feedback signal error (AErr)	
		33: Reserved	
		34: Motor overheating (PTC1)	
		35: PID feedback fault (FbE)	
		36: PID feedback error (dEv)	
		37: Output phase loss (OPHL)	
		38–40: Reserved	
↗ 06.13	Detection Time for Motor Phase Loss	0.0: Disabled 0.1–60.0 sec.	0
↗ 06.14	Detection Current Level for Motor Phase Loss	10–100%	30
06.26	Output Frequency Fault 1 (Hz)	0–65535	0
06.27	Output Current Fault 1	0–65535	0
06.28	Output Voltage Fault 1	0–65535	0
06.29	DC bus Voltage Fault 1	0–65535	0

Pr.	Parameter Name	Setting Range	Default
06.30	Drive Internal Temperature Fault 1	0-65535	0
06.31	Output Frequency Fault 2 (Hz)	0-65535	0
06.32	Output Current Fault 2	0-65535	0
06.33	Output Voltage Fault 2	0-65535	0
06.34	DC bus Voltage Fault 2	0-65535	0
06.35	Drive Internal Temperature Fault 2	0-65535	0
06.36	Output Frequency Fault 3 (Hz)	0-65535	0
06.37	Output Current Fault 3	0-65535	0
06.38	Output Voltage Fault 3	0-65535	0
06.39	DC bus Voltage Fault 3	0-65535	0
06.40	Drive Internal Temperature Fault 3	0-65535	0
06.41	Output Frequency Fault 4 (Hz)	0-65535	0
06.42	Output Current Fault 4	0-65535	0
06.43	Output Voltage Fault 4	0-65535	0
06.44	DC bus Voltage Fault 4	0-65535	0
06.45	Drive Internal Temperature Fault 4	0-65535	0
06.46	Output Frequency Fault 5 (Hz)	0-65535	0
06.47	Output Current Fault 5	0-65535	0
06.48	Output Voltage Fault 5	0-65535	0
06.49	DC bus Voltage Fault 5	0-65535	0
06.50	Drive Internal Temperature Fault 5	0-65535	0
06.51	OL2 Over-Torque Detection Level Selection	0: Based on motor's rated current (Pr.07.00) 1: Based on driver's rated current (Pr.00.01)	0

Chapter 4 Parameters | VFD-EL-W

07 Motor Parameters

✎ You can set this parameter during operation.

Pr.	Parameter Name	Setting Range	Default
✎ 07.00	Motor Rated Current	30–120% FLA (FLA: drive's rated current)	100% FLA
✎ 07.01	No-Load Current for Motor	0–99% FLA	40% FLA
✎ 07.02	Auto-Torque Compensation	0.0–10.0	0.0
✎ 07.03	Torque Compensation Gain	0.00–10.00	0.00
✎ 07.04	Motor Parameter Auto-Tuning	0: Disabled 1: Auto-tuning R1 (motor does not run) 2: Auto-tuning R1 + no-load current (motor runs)	0
07.05	Motor Resistance R1 (Line to Line)	0–65535 mΩ	0
07.06	Motor Rated Slip	0.00–20.00 Hz	3.00
07.07	Slip Compensation Limit	0–250%	200
07.08	Torque Compensation Low Pass Filter Time	0.01–10.00 sec.	0.10
07.09	Slip Compensation Low Pass Filter Time	0.05–10.00 sec.	0.20
07.10	Accumulated Motor Operation Time (Minutes)	00–1439 min.	0
07.11	Accumulated Motor Operation Time (Days)	00–65535 days	0
07.12	Motor PTC Overheating Protection	0: Disable 1: Enable	0
07.13	Motor PTC Overheating Protection Input Filter Time	0–9999 (unit: 2ms)	100
07.14	Motor PTC Overheating Protection Level	0.1–10.0 V	2.4
07.15	Motor PTC Overheating Warning Level	0.1–10.0 V	1.2
07.16	Motor PTC Overheating Warning Reset Level Difference	0.1–5.0 V	0.6
07.17	Motor PTC Overheating Action	0: Warn and ramp to stop 1: Warn and coast to stop 2: Warn and continue operation	0

08 Special Parameters

✎ You can set this parameter during operation.

Pr.	Parameter Name	Setting Range	Default
08.00	DC Brake Current Level	0–100%	0
08.01	DC Brake Time at Start-up	0.0–60.0 sec.	0.0
08.02	DC Brake Time at STOP	0.0–60.0 sec.	0.0
08.03	DC Brake Frequency at STOP	0.00–400.0 Hz	0.00
08.04	Momentary Power Loss Action	0: Stop operation 1: Operation continues after momentary power loss, speed search starts with the last frequency 2: Operation continues after momentary power loss, speed search starts with the minimum frequency	0
08.05	Maximum Allowable Power Loss Time	0.1–20.0 sec.	2.0
08.06	Base Block Speed Search	0: Disable 1: Speed search starts with the last speed before B.B. 2: Speed search starts with the minimum speed	1
08.07	Speed Tracking Delay Time	0.1–5.0 sec.	0.5
08.08	Speed Tracking Action Level	30–200%	150
✎ 08.09	Skip Frequency 1 Upper Limit	0.00–400.0 Hz	0.00
✎ 08.10	Skip Frequency 1 Lower Limit	0.00–400.0 Hz	0.00
✎ 08.11	Skip Frequency 2 Upper Limit	0.00–400.0 Hz	0.00
✎ 08.12	Skip Frequency 2 Lower Limit	0.00–400.0 Hz	0.00
✎ 08.13	Skip Frequency 3 Upper Limit	0.00–400.0 Hz	0.00
✎ 08.14	Skip Frequency 3 Lower Limit	0.00–400.0 Hz	0.00
08.15	Number of Times of Restart after Fault	0–10	0
08.16	Auto-restart Interval of Fault	0.1–6000.0 sec.	60.0
08.17	Auto-Energy Saving Operation	0: Disable 1: Enable	0
08.18	Automatic Voltage Regulation (AVR) Function	0: Enable AVR 1: Disable AVR 2: Disable AVR during deceleration 3: Disable AVR at STOP	0
08.19	Reserved		
✎ 08.20	Oscillation Suppression	0.0–5.0	0.0

09 Communication Parameters

⚡ You can set this parameter during operation.

Pr.	Parameter Name	Setting Range	Default
⚡ 09.00	Communication Address	1–254	1
⚡ 09.01	Communication Transmission Speed	0: Baud rate 4800 bps 1: Baud rate 9600 bps 2: Baud rate 19200 bps 3: Baud rate 38400 bps	1
⚡ 09.02	Communication Fault Treatment	0: Warn and continue operation 1: Warn and ramp to stop 2: Warn and coast to stop 3: No treatment and no fault	3
⚡ 09.03	Communication Time-Out Detection	0.0: No function 0.1–120.0 sec.	0.0
⚡ 09.04	Communication Protocol	0: 7, N, 2 for ASCII 1: 7, E, 1 for ASCII 2: 7, O, 1 for ASCII 3: 8, N, 2 for RTU 4: 8, E, 1 for RTU 5: 8, O, 1 for RTU 6: 8, N, 1 for RTU 7: 8, E, 2 for RTU 8: 8, O, 2 for RTU 9: 7, N, 1 for ASCII 10: 7, E, 2 for ASCII 11: 7, O, 2 for ASCII	0
09.05	Reserved		
09.06	Reserved		
⚡ 09.07	Communication Response Delay Time	0–200 (unit: 2ms)	1
⚡ 09.08	Communication Keypad Selection	0: PU06 1: PU08	0

10 PID Control Parameters

✎ You can set this parameter during operation.

Pr.	Parameter Name	Setting Range	Default
10.00	PID Set Point Selection	0: PID function disabled 1: Digital keypad 2: Reserved 3: Reserved 4: PID reference target value (Pr.10.11)	0
10.01	Input Terminal for PID Feedback	0: Positive PID feedback from external terminal AVI (0–10 V _{DC}) 1: Negative PID feedback from external terminal AVI (0–10 V _{DC}) 2: Positive PID feedback from external terminal ACI (4–20 mA) 3: Negative PID feedback from external terminal ACI (4–20 mA)	0
✎ 10.02	Proportional Gain (P)	0.0–10.0	1.0
✎ 10.03	Integral Time (I)	0.00–100.0 sec.	1.00
✎ 10.04	Differential Time (D)	0.00–1.00 sec.	0.00
10.05	Upper Limit of Integral Control	0–100%	100
10.06	PID Delay Time	0.0–2.5 sec.	0.0
10.07	PID Output Frequency Limit	0–110%	100
10.08	PID Feedback Signal Error Detection Time	0.0–3600 sec. (0.0: disable)	60.0
10.09	PID Feedback Signal Error Treatment (Analog input)	0: Warn and ramp to stop 1: Warn and coast to stop 2: Warn and continue operation	0
10.10	PID Detection Value Gain	0.0–10.0	1.0
✎ 10.11	PID Target Value	0.00–400.0 Hz (valid when Pr.10.00 = 4)	0.00
10.12	PID Feedback Signal Error Deviation Level	0.0–100.0%	10.0
10.13	PID Feedback Signal Error Deviation Detection Time	0.1–300.0 sec.	5.0
10.14	Sleep Detection Time	0.0–6550 sec.	0.0
10.15	Sleep Frequency	0.00–Fmax	0.00
10.16	Wake-up Frequency	0.00–Fmax	0.00
10.17	PID Offset	0.00–60.00 Hz	0

Chapter 4 Parameters | VFD-EL-W

Pr.	Parameter Name	Setting Range	Default
10.18	PID Feedback Physical Quantity	1.0–99.9	99.9
10.19	PID Calculation Mode Selection	0: Serial connection 1: Parallel connection	0
10.20	PID Error Deviation Treatment	0: Warn and continue operation (no treatment) 1: Warn and coast to stop 2: Warn and ramp to stop 3: Ramp to stop and restart after Pr.10.21 delay time (no fault or warning) 4: Ramp to stop and restart after Pr.10.21 delay time. The number of times of restart is limited by Pr.10.50	0
10.21	PID Error Deviation Restart Delay Time	0–9999 sec.	60
↗ 10.22	Set Point Deviation Level	0–100%	0
↗ 10.23	Set Point Stop Detection Time	0–9999 sec.	10
↗ 10.24	Deviation Level of Liquid Leakage	0–50%	0
↗ 10.25	Liquid Leakage Change Detection	0: Disable 0–100%	0
↗ 10.26	Liquid Leakage Change Detection Time	0: Disable 0.1–10.0 sec.	0.5
10.27 – 10.34	Reserved		
10.35	Multi-Pump Operation Mode	00: Disable 01: Fixed time circulation (alternative operation) 02: Fixed quantity control (multi-pump operating at constant pressure)	0
10.36	Multi-Pump ID	1: Master 2–4: Slave	0
↗ 10.37	Multi-Pump Fixed Time Circulation Period	1–65535 min.	60
↗ 10.38	Pump Switching Start-up Frequency	0.00 Hz–Fmax	60.00
↗ 10.39	Pump Reaches Start-Up Frequency Detection Time	0.0–3600.0 sec.	1
↗ 10.40	Pump Switching Stop Frequency	0.00 Hz–Fmax	48.00

Pr.	Parameter Name	Setting Range	Default
↗ 10.41	Pump Reaches Switching Stop Frequency Detection Time	0.0–3600.0 sec.	1
↗ 10.42	Pump's Frequency at Time-Out (Disconnection)	0.0–Fmax	0.00
10.43	Pump Fault Treatment	bit 0: When the operating pump is failed, whether it switches to an alternative pump or not 0: Stop all pump action 1: Switch to an alternative pump bit 1: During the operation, stop or standby after resetting from error 0: Standby after resetting 1: Stop after resetting bit 2: Whether the system can run or not when the pump has an error 0: The system cannot activate 1: The system selects another pump to operate	1
10.44	Pump Start-Up Sequence Selection	0: By pump ID 1: By the operating time	0
↗ 10.45	Pump Alternative Operation Time Setting	0.0–360.0 sec.	60.0
10.46 – 10.48	Reserved		
↗ 10.49	Setting Method for Pr.10.12	0: Use the existed setting (default), judging by the feedback deviation 1: Set the low water pressure percentage (%), check for any fault by the feedback physical quantity	0
↗ 10.50	Number of Times of PID Restart after Fault	0–1000 times	0

4-2 Parameter Settings for Applications

Speed Search

The operating motor can be restarted without waiting for a complete stop. The drive automatically searches the motor speed, and accelerates when the speed reaches the motor speed.

Applications	Purpose	Related Parameters
Inertial loads such as windmills and winding equipment	The motor restarts during operation	08.04–08.08

DC Brake before Operation

For a free-running motor, if the operation direction is uncertain, execute DC braking before start-up.

Applications	Purpose	Related Parameters
Loads that can be moved when windmills and water pumps stop	The motor restarts during operation	08.00, 08.01

Energy-Saving Operation

Save energy according to the set proportion when the AC motor drive runs at constant speed, yet has full power during acceleration and deceleration. Applicable for vibration reduction of precision machine tools.

Applications	Purpose	Related Parameters
Punch press, precision machine tools	Save energy, reduce vibration	08.17

Eight-step Speed Operation

Use simple contact signals to control eight-step speed, including master frequency (four-step speed) operation.

Applications	Purpose	Related Parameters
Conveying machinery	Cyclic operation at multi-step speed	Pr.04.06–04.08, Pr.05.00–05.06

Multi-step Acceleration and Deceleration Switching Operation

Use external signals to switch multi-step acceleration and deceleration operation. When an AC motor drive drives more than two motors, it reaches high speed operation, but still start/ stop smoothly.

Applications	Purpose	Related Parameters
Auto-turntable for Conveying machinery	Switch acceleration and deceleration time through external signals	Pr.01.09–01.12. Pr.04.06–04.08

Overheat warning

When an AC motor drive overheats, a thermal sensor triggers the overheating warning.

Applications	Purpose	Related Parameters
Air conditioners	Safety measure	Pr.03.00, Pr.04.06–04.08

Operation Command

Select the AC motor drive control by external terminals or digital keypad

Applications	Purpose	Related Parameters
General application	Select the control signal source	Pr.02.01, Pr.04.06–04.08

Frequency Hold

Hold the output frequency during acceleration and deceleration

Applications	Purpose	Related Parameters
General application	Acceleration/ deceleration pause	Pr.04.06–04.08

Auto-restart after Fault

The AC motor drive can automatically restart/ reset up to 10 times after a fault occurs.

Applications	Purpose	Related Parameters
Air conditioners	For continuous and reliable operation	Pr.08.15, Pr.08.16

DC Brake Emergency Stop

The AC motor drive can use the DC brake for emergency stop when a quick stop is needed without a brake resistor.

Applications	Purpose	Related Parameters
High-speed rotors	Emergency stop without DC resistor	Pr.08.00–08.03

Over-torque Setting

Set the internal motor or mechanical over-torque detection level. When over-torque occurs, the drive automatically adjusts the output frequency.

It is suitable for machines like fans and pumps that require continuous operation.

Applications	Purpose	Related Parameters
Pumps, fans and extruders	To protect machines and enhance continuous/ reliable operation	Pr.06.00–06.05

Upper/ Lower Limit Frequency

When the external signals cannot provide upper/ lower limits, gain and bias, you can set the limits individually in the AC motor drive.

Applications	Purpose	Related Parameters
Pumps and fans	Control the motor speed within the upper/ lower limit	Pr.01.07, Pr.01.08

Skip Frequency Setting

The AC motor drive does not run at constant speed in the skip frequency range. You can set up to three skip frequency ranges.

Applications	Purpose	Related Parameters
Pumps and fans	To prevent machine resonance vibration	Pr.08.09–08.14

Chapter 4 Parameters | VFD-EL-W**Carrier Frequency Setting**

Increase the carrier frequency to reduce motor noise

Applications	Purpose	Related Parameters
General application	Reduce noise	Pr.02.03

Keep Running when Frequency Command is Lost

When the frequency command is lost due to system malfunction, the AC motor drive can still operate.

Applicable for air-conditioning equipment of intelligent buildings

Applications	Purpose	Related Parameters
Air conditioners	For continuous operation	Pr.02.06

Output Signal during Operation

Brake release when the AC motor drives gives a signal during motor operation. (Signal disappears when the AC motor drive is free-running.)

Applications	Purpose	Related Parameters
General application; mechanical brake	Provide a signal for operation status	Pr.03.00

Output Signal at Zero Speed

When the drive's output frequency is lower than the minimum output frequency, it gives a signal for an external system or control wiring.

Applications	Purpose	Related Parameters
General application; machine tools	Provide a signal for operation status	Pr.03.00

Output Signal at set Frequency

When the drive's output frequency reaches the set frequency, it gives a signal for an external system or control wiring.

Applications	Purpose	Related Parameters
General application; machine tools	Provide a signal for operation status	Pr.03.00

Output Signal at Over-torque

When the motor over-torque is larger than the drive's setting level, it gives a signal to prevent the machine from damage due to the load.

Applications	Purpose	Related Parameters
Machine tools, fans, pumps and extruders	To protect machines and for reliable operation	Pr.03.00, Pr.06.04–06.05

Output Signal at Low Voltage

When low voltage is detected after the motor detects the P-N voltages, the drive gives a signal for an external system or control wiring.

Applications	Purpose	Related Parameters
General application	Provide a signal for operation status	Pr.03.00

Output Signal at Desired Frequency

When the drive's output frequency reaches the desired frequency, it gives a signal for an external system or control wiring.

Applications	Purpose	Related Parameters
General application	Provide a signal for operation status	Pr.03.00–03.02

Output Signal for Base Block

When the drive executes a Base Block, it gives a signal for an external system or control wiring.

Applications	Purpose	Related Parameters
General application	Provide a signal for operation status	Pr.03.00

Overheating Warning for IGBT or Heat Sink

When the heat sink overheats, it gives a signal for an external system or control wiring.

Applications	Purpose	Related Parameters
General application	Safety measure	Pr.03.00

4-3 Description of Parameter Settings

00 User Parameters

✈ You can set this parameter during operation.

00.00 AC Motor Drive Identity Code

Default: ##

Settings Read only

00.01 AC Motor Drive Rated Current Display

Default: ##

Settings Read only

📖 Pr.00.00 displays the AC motor drive identity code. The identity code includes the drive's capacity, rated current, rated voltage and the maximum carrier frequency. Use the following specification table to check if the AC motor drive is correct.

📖 Pr.00.01 indicates the drive's rated output current. You can use it to check if the AC motor drive is correct.

Table for capacity, identity code and rated current:

230V Models					
Power (kW)	0.2	0.4	0.75	1.5	2.2
Power (HP)	0.25	0.5	1.0	2.0	3.0
Identity Code	0	2	4	6	8
Rated current	1.6	2.5	4.2	7.5	11.0
Carrier Frequency	12 kHz				

460V Models						
Power (kW)	0.4	0.75	1.5	2.2	4.0	5.5
Power (HP)	0.5	1.0	2.0	3.0	5.5	7.5
Identity Code	3	5	7	9	11	13
Rated current	1.5	2.5	4.2	5.5	9.0	13
Carrier Frequency	12 kHz					

00.02 Parameter Reset

Default: 0

Settings

- 0: Parameter can be read/written
- 1: All parameters are read only
- 7: Keypad and frequency setting knob locked
- 8: Keypad lock
- 9: Reset all parameters to defaults (50 Hz, 230V/400V or 220V/380V depends on Pr.00.12)
- 10: Reset all parameters to defaults (60 Hz, 220V/440V)

📖 9 or 10: Reset all parameters to defaults when the parameters settings are abnormal.

📖 9: Resets all parameters to defaults for 50 Hz; the base voltage depends on the setting for Pr.00.12.

📖 1: All parameters are read-only and cannot be changed. Err displays when you enter any input.

To write all parameters, set Pr.00.02 = 0.















- 📖 7: Long press the ENTER key for 5 sec. to lock the keypad and setting knob. When the frequency command source is the keypad potentiometer (Pr.02.00 = 4), set Pr.00.02 = 7 after setting the required frequency command, then the keypad potentiometer does not change the drive's frequency command.
- 📖 8: Long press the ENTER key for 5 sec. to lock the keypad. Long press ENTER key for 5 sec. again to unlock the keypad.

00.03 Start-up Display Default: 0

- Settings
- 0: F (frequency command)
 - 1: H (output frequency)
 - 2: A (output current)
 - 3: U (user-defined)
 - 4: FWD/REV command

- 📖 Determines the start-up display page after power is applied to the drive.
- 📖 Gets into the self-check state first when the drive starts-up, after displays "Pon" and flashes for 5 sec., the drive turns to start-up page.

00.04 Content of Multi-function Display (User-Defined) Default: 0

- Settings
- 0: Display the content of user-defined unit 
 - 1: Display counter value (c) 
 - 2: Display the status of multi-function input terminal (d)
 - For example
 - Only MI1 terminal activates: 
 - Only MI2 terminal activates: 
 - MI2, MI3 and MI4 operate at the same time: 
 - By analogy, MI1-MI4 are displayed in order from left to right 
 - 3: Display the drive's DC bus voltage (u) 
 - 4: Display the drive's output voltage (E) 
 - 5: Display PID analog feedback signal (b) 
 - 6: Display the drive's power factor angle (n) 
 - 7: Display the drive's output power (P) 
 - 8: Display the setting value and the feedback of PID control (P) 
 - 9: Display AVI analog input terminal signal (V) (I) 
 - 10: Display ACI analog input terminal signal (mA/V) (i) 
 - 11: Display IGBT temperature (°C) (h) 

- 📖 When Pr.00.03 is set to 3, use Pr.00.04 to select the displayed content as needed.
- 📖 When Pr.00.04 = 5, the displayed PID feedback value is the percentage (%) of the terminal measurement range.

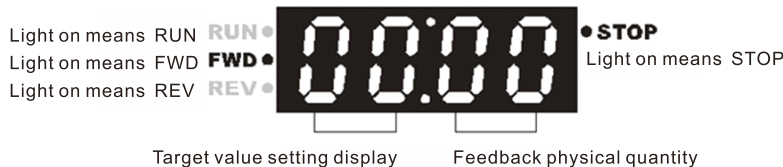

Chapter 4 Parameters | VFD-EL-W

 In the flow control occasions such as constant pressure water pumps using PID control, set Pr.00.03 = 3 and Pr.00.04 = 8. When the drive reboots after powered off, the start-up screen displays 00:00 (as shown in the figure above). The displayed value on the left of “:” is the physical quantity of PID target value; on the right of “:” shows the sensor output value (0–10V/4–20 mA) corresponding to the actual physical quantity.

 Refer to Pr.10.00 to set the target value; and Pr.10.18 to set the feedback value.

 If the set and displayed target value directly correspond to physical quantities such as pressure, temperature, flow, etc., you also need to set Pr.00.13 and Pr.00.14 at the same time.

00.05 User-Defined Coefficient K

Default: 1.0

Settings 0.1–160.0 (unit: 0.1)

 Determines the multiplying factor (K) for the user-defined unit. User-defined unit (U) = Output frequency (H) × use-defined coefficient (K) (Pr.00.05)

00.06 Software Version

Default: #.#

Settings Read only

00.07 Software Version (Date)

Default: Read only

Settings Read only

 Displays the current drive software version by date.

00.08 Parameter Protection Password Input

Default: 0

Settings 0–9999 (unit: 1)

 0–2: the number of password attempts allowed

 When Pr.00.09 has set the parameter protection password, enter the set password in Pr.00.09 to unlock the protection and to make changes to the parameter. You are limited to a maximum of three attempts. After three consecutive failed attempts, a blinking “codE” appears. You must restart the AC motor drive before trying again to enter the correct password. To avoid problems in the future, be sure to write down the password after you set this parameter. If you forget the password, send back to the factory to decode.

00.09 Parameter Protection Password Setting

Default: 0

Settings 0–9999 (unit: 1)

 After setting the password, long press the ENTER key for more than 5 seconds to enable the password.

 0: No password protection or password is entered correctly (Pr.00.08) 1: Password has been set

 This parameter is for setting the password protection. Password can be set directly the first time. After you set the password, the value of Pr.00-08 is 1, which means password protection is activated. On the contrary, Pr.00.08 = 0 means no password protection. You can set and change all parameters, including Pr.00.09. At this time, if you want to change any of the parameter

settings, you must enter the correct password in Pr.00.08 to deactivate the password temporarily, and this would make Pr.00.09 become 0.

NOTE:

If you set Pr.00.09 to 0, you deactivate the password protection function. There will be no password protection when you reboot the drive. On the contrary, when Pr.00.09 is not set to 00, the password protection is activated permanently, and is always reactivated after you reboot the motor drive. At this time, if you want to change any of the parameter settings, you must enter the correct password in Pr.00.08 to deactivate the password temporarily, and then you can set all parameters.

Pr.00-07 and Pr.00-08 are used to prevent personnel from setting other parameters by accident.

Step 1: Enter the original password in Pr.00.08 again (or you can set a new password; be sure to record it).

Step 2: Reboot the drive to enable the password protection.

Step 3: Enter any value that is not the password in Pr.00.08). (Pr.00.08 displays End regardless of whether the password is entered correctly.)

Password Decode Flow Chart

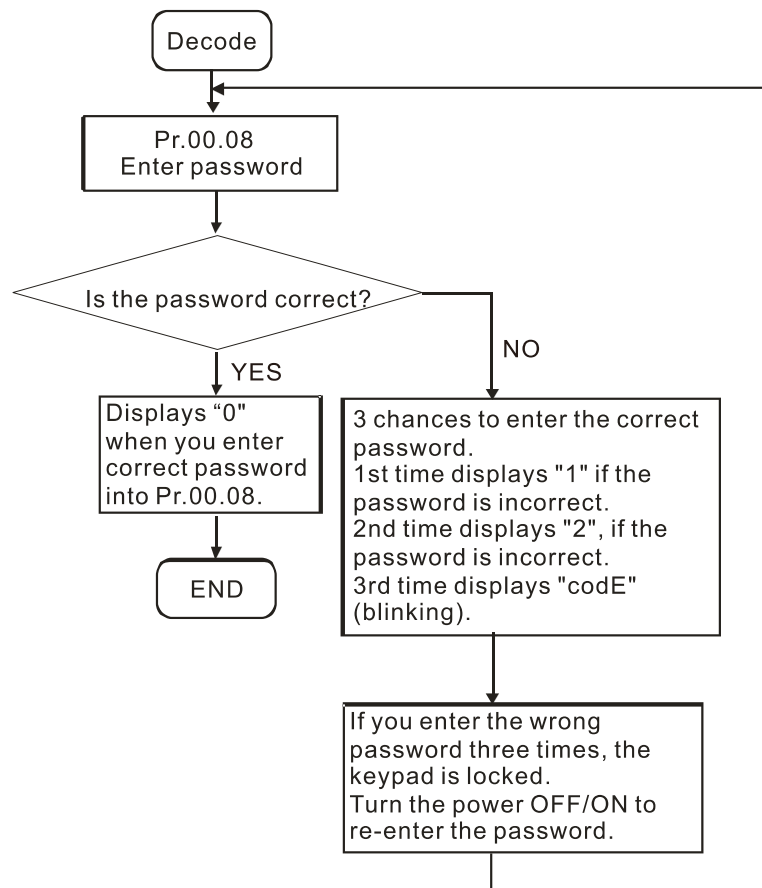

Chapter 4 Parameters | VFD-EL-W

Instruction for Pr.00.02 = 8, Pr.00.08 and Pr.00.09 password usage

Protection		Protection Effort	Notes for Unlock/Decoding
Setting 1	Password lock only Use Pr.00.09 to set protection password (1–4 digits)	<ol style="list-style-type: none"> (1) Pr.00.09 displays 01 after the password is set successfully (this parameter tells whether the parameter is set). (2) Enter the password to unlock by Pr.00.08, but it shows the times of incorrect password input and displays CodE error when you enter the wrong password for three times. Reboot the motor drive to re-enter the correct password. (3) Check other parameter values that are displayed as 0.00 (according to the original decimal places of the parameters), which protects the customer's parameters. (4) You can still modify the frequency command (F) and PID target value. (5) It is not available to modify other parameters except points 2 and 4 mentioned above. 	<ol style="list-style-type: none"> (1) Set Pr.00.08 to the same password as Pr.00.09 to deactivate the password. (2) After deactivate the password, if you need to use the protection function, reset Pr.00.09. (3) If you forget the password in Pr.00.09, contact Delta for customer service.
Setting 2	Keypad lock only Set Pr.00.02 = 8 to lock the keypad	<ol style="list-style-type: none"> (1) Parameters can still be checked after keypad locked. (2) You cannot change any parameters including frequency command (F) after keypad locked. 	<ol style="list-style-type: none"> (1) Long press the ENTER key for 5 seconds to unlock the keypad, and get back to Frequency command page, and then you can change parameters. If Pr.00.02 is still set to 8, the keypad is still locked when you reboot the motor drive. (2) To deactivate keypad lock, long press the ENTER key for 5 seconds, then set Pr.00.02 to 0.

Protection		Protection Effort	Notes for Unlock/Decoding
Setting 3	Combination setting (1) Set Pr.00.02 = 8 to lock the keypad first (2) Long press the ENTER key for 5 seconds, set Pr.00.02 = 8 to unlock the keypad and then set password in Pr.00.09. After the password is set, check Pr.00.02 displayed as 00 (indicating that the parameter is encrypted). (3) Reboot the drive to finish the combination setting. If you only finish the setting of Step 2, the keypad is still not locked even though you cannot check parameters through the keypad.	(1) Check other parameter values that are displayed as 0.00 (according to the original decimal places of the parameters), which protects the customer's parameters. (2) You cannot change all parameters, including frequency command (F) and PID target value.	(1) If you need to change the process controlling parameters such as frequency command (F) or PID target value, long press the ENTER key for 5 seconds to modify these parameters. But other parameters are still displayed as 0.00 (according to the original decimal places of the parameter) and cannot be modified. (2) To change other parameters except the above mentioned in point 1, set Pr.00.08 again.

00.10 Control Method

Default: 0

Settings 0: V/F voltage frequency control

1: Vector control

 Determines the control mode of the AC motor drive.

 V/F voltage/ frequency control:

The V/F control is a constant value control mode. It stops the main problem of frequency decreasing and magnetic field increasing. However, the magnetic field is not constant, an insufficiency of motor's torque in a weaken low frequency magnetic field may happen as the frequency decreases. Set Pr.07.02 (Torque Compensation) properly to compensate the torque for the best operating performance.

Applications: water pumps, conveyors, compressors and treadmills.

 Vector control:

Eliminate the related effect between the filed current vector and the armature flux. It auto-tunes the torque compensation and slip compensation to increase the dynamic response of the motor drive.

Applications: textile equipment, printing equipment, crane equipment and drilling machinery.

Related parameters: Pr.07.02 Torque Compensation

00.11 Reserved**00.12** 50 Hz Power System Base Voltage Setting

Default: 0



Settings 0: 230V/ 400V
1: 220V/ 380V

 Determines the base voltage initial value when the motor drive resets with 50 Hz power system.

00.13 User-Defined Value (corresponds to Max. operation frequency Pr.01.00)

Default: 0



Settings 0–9999

-  Corresponds to the maximum operation frequency (Pr.01.00)
-  When Pr.00.13 is not set to zero, “F” automatically disappears in the frequency setting page, and the displayed last digit blinks. The Up/down key, multi-step speed and JOG function on the keypad all changes ranges according to Pr.00.13.
-  When Pr.00.13 is not set to zero, and the frequency source is communication, use Pr.02.18 to change the frequency command instead of using communication address 2001H.

00.14 Decimal Places for User-Defined Value

Default: 0



Settings 0–3

-  Sets the digital places for Pr.00.13.
-  For example: if the corresponding physical quantity such as pressure is to be set as 10.0 bar, you need to set Pr.00.13 to 100, and set Pr.00.14 to 1. Pressure conversion relation: 0.1 Mpa = 1 bar = 1 kgf-cm²

00.15 Output Phase Order Selection

Default: 0

Settings 0: Standard
1: Reverse the operation direction

-  Without changing the output wiring of the motor drive, the actual running direction of the motor can be changed from forward to reverse and reverse to forward through this parameter, and the indicator signals (FWD, REV) on the keypad remain unchanged.
-  When using this parameter with Pr.02.04 (Motor Direction Control), the output logic is to first judge whether there is a prohibited direction, and then whether to output the reverse direction. If a certain direction is prohibited, no action will be taken.

00.16 Prohibit Write EEPROM Function

Default: 0

Settings 0: Prohibit write EEPROM
1: Enable, control via MI terminal
2: Enable, MI terminal is invalid

01 Basic Parameters

✈ You can set this parameter during operation.

01.00 Max. Operation Frequency

Default: 60.00 / 50.00

Settings 50.00–400.00 Hz

01.01 Motor Rated Frequency

Default: 60.00 / 50.00

Setting 0.10–400.00 Hz

📖 Set this parameter according to the rated voltage on the motor nameplate.

01.02 Motor Rated Voltage

Default:

Settings 230V models: 0.1–255.0 V 220.0/ 230.0
460V models: 0.1–510.0 V 380.0/ 400.0

📖 The default of motor rated voltage is different according to different models of 230V/ 460V and Pr.00.02 setting 9 or 10. Refer to the following table.

	(Pr.00-12)	(Pr.00-02)	Pr.01-01	Pr.01-02
230V Models	0	9	50.00 (Hz)	230.0 V
		10	60.00 (Hz)	220.0 V
	1	9	50.00 (Hz)	220.0 V
		10	60.00 (Hz)	220.0 V
460V Models	0	9	50.00 (Hz)	400.0 V
		10	60.00 (Hz)	400.0 V
	1	9	50.00 (Hz)	380.0 V
		10	60.00 (Hz)	400.0 V

📖 Sets the maximum output voltage. This parameter must be set smaller than or equal to the rated voltage on the motor nameplate.

01.03 Mid-Point Frequency Setting

Default: 1.5

Settings 0.10–400.0 Hz

📖 Sets the Mid-point Frequency of any V/F curve. This setting determines the V/F ratio between the Minimum Frequency and the Mid-point Frequency.

01.04 Mid-Point Voltage Setting

Default: 10.0 / 20.0

Settings 230V models: 0.1–255.0 V
460V models: 0.1–510.0 V

📖 For 230V models, the default is 10.0 V; for 460V models, the default is 20.0 V.

📖 Sets the Mid-point Voltage of any V/F curve. This setting determines the V/F ratio between the Minimum Frequency and the Mid-point Frequency.

01.05 Min. Output Frequency Setting (Hz)

Default: 1.5

Settings 0.10–400.0 Hz

📖 Sets the minimum start-up frequency of V/F curve.

01.06 Min. Output Voltage Setting

Default: 10.0 / 20.0

Settings 230V models: 0.1–255.0 V
460V models: 0.1–510.0 V

- 📖 For 230V models, the default is 10.0 V; for 460V models, the default is 20.0 V.
- 📖 Sets the minimum start-up voltage of V/F curve.
- 📖 The settings for Pr.01.01–Pr.01.06 must meet the condition of $\text{Pr.01.02} \geq \text{Pr.01.04} \geq \text{Pr.01.06}$ and $\text{Pr.01.01} \geq \text{Pr.01.03} \geq \text{Pr.01.05}$.

01.07 Output Frequency Upper Limit

Default: 110.0

Settings 0.1–120.0%

- 📖 This parameter must be equal to or greater than the Output Frequency Lower Limit (Pr.01.08).
The Maximum Output Frequency (Pr.01.00) is equal to 100%.
- 📖 The Output Frequency Upper Limit = $(01.00 \times 01.07) \div 100$

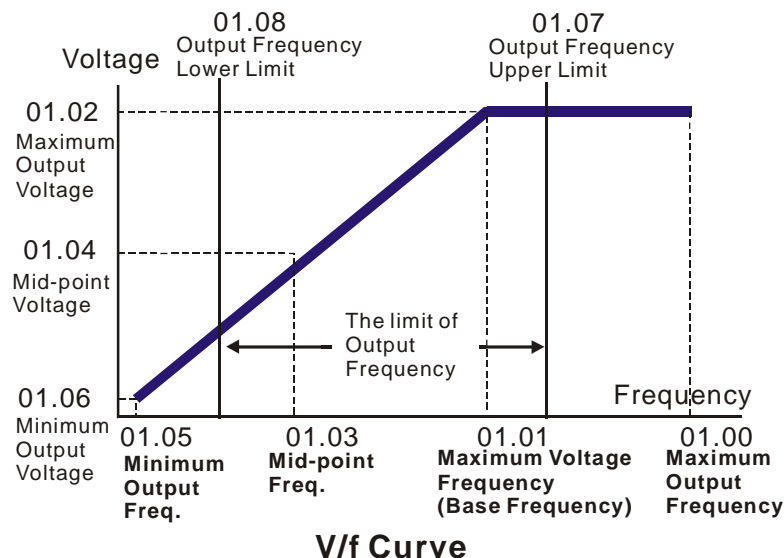
**01.08** Output Frequency Lower Limit

Default: 0.0

Settings 0.0–100.0%

- 📖 Calculation: The Output Frequency Lower Limit = $(01.00 \times 01.08) \div 100$
- 📖 Use the output frequency upper and lower limit settings to prevent operator misuse, overheating caused by the motor's operating at a too low frequency, or mechanical wear due to a too high speed.
- 📖 If the output frequency upper limit setting is 50 Hz and the frequency setting is 60 Hz, the maximum output frequency is 50 Hz.
- 📖 If the output frequency lower limit setting is 10 Hz and the minimum output frequency setting (Pr.01-07) is 1.5 Hz, then the drive operates at 10 Hz when the Frequency command is higher than Pr.01-07 but lower than 10 Hz. If the Frequency command is lower than Pr.01-05, the drive is in ready status without output.
- 📖 If the frequency output upper limit is 60 Hz and the frequency setting is also 60 Hz, the

maximum output frequency will not be larger than 60 Hz even executing slip compensation. If the output frequency must be larger than 60 Hz, adjust the output frequency upper limit or increase the maximum operation frequency.

- ✎ **01.09** Acceleration Time 1
- ✎ **01.10** Deceleration Time 1
- ✎ **01.11** Acceleration Time 2
- ✎ **01.12** Deceleration Time 2

Default: 10.0

Settings 0.1–600.0 sec./ 0.01–600.00 sec.

📖 You can switch the acceleration/ deceleration time 1 or 2 by setting the external terminal MI2–MI4 to 7.

01.19 Time Unit for Acceleration and Deceleration

Default: 0

Settings 0: Unit 0.1 sec.

1: Unit 0.01 sec.

📖 The acceleration time determines the time required for the AC motor drive to ramp from 0.00 Hz to the maximum operation frequency (Pr.01.00). The deceleration time determines the time required for the AC motor drive to decelerate from the maximum operation frequency (Pr.01.00) down to 0 Hz.

📖 Select the Acceleration/Deceleration Time 1, 2, 3, 4 with the multi-function input terminal settings. The defaults are Acceleration Time 1 and Deceleration Time 1.

📖 The setting for Pr.01.19 changes the time unit of Pr.01.09–Pr.01.12, Pr.01.13, and Pr.01.14, further changing the setting range of the acceleration / deceleration time.

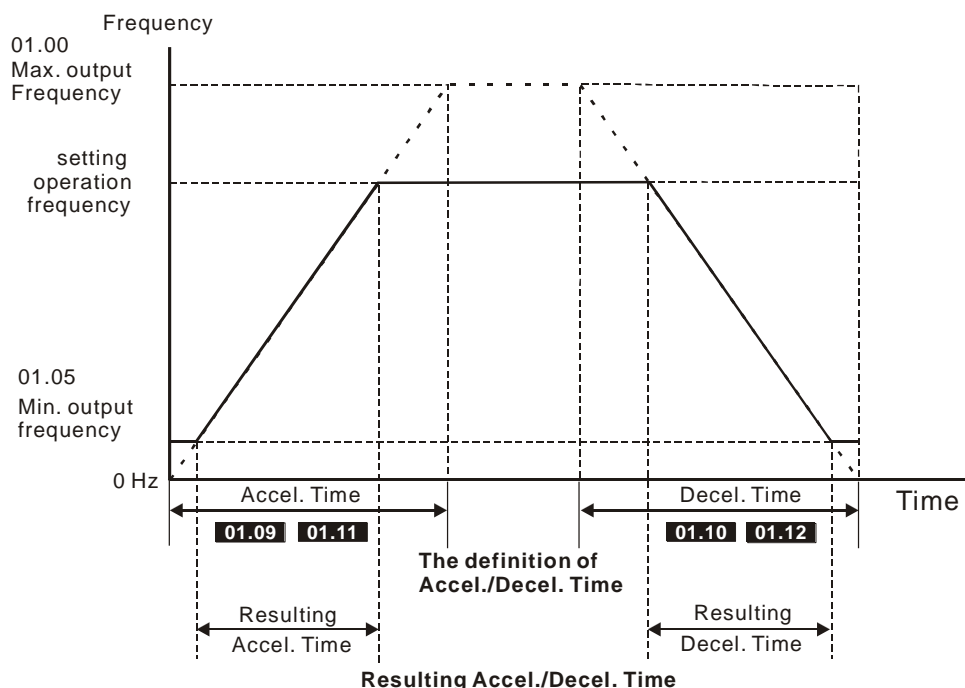

01.13 JOG Acceleration Time

Default: 1.00

Settings 0.1–600.0 sec./ 0.01–600.00 sec.

01.14 JOG Deceleration Time

Default: 1.00

Settings 0.1–600.0 sec./ 0.01–600.00 sec.

01.15 JOG Frequency Setting

Default: 6.00

Settings 0.10–400.0 Hz

Use only external terminal JOG (setting MI2, MI3 or MI4 to 8). When the JOG command is ON, the AC motor drive accelerates from the Minimum Output Frequency (Pr.01.05) to the JOG Frequency (Pr.01.15). When the JOG command is OFF, the AC motor drive decelerates from the JOG frequency to stop. The acceleration/ deceleration time is set by the JOG Acceleration/ Deceleration time (Pr.01.13, Pr.01.14).

The drive must be stopped before using the JOG command. During JOG operation, other operation commands are not accepted, except FORWARD/REVERSE commands.

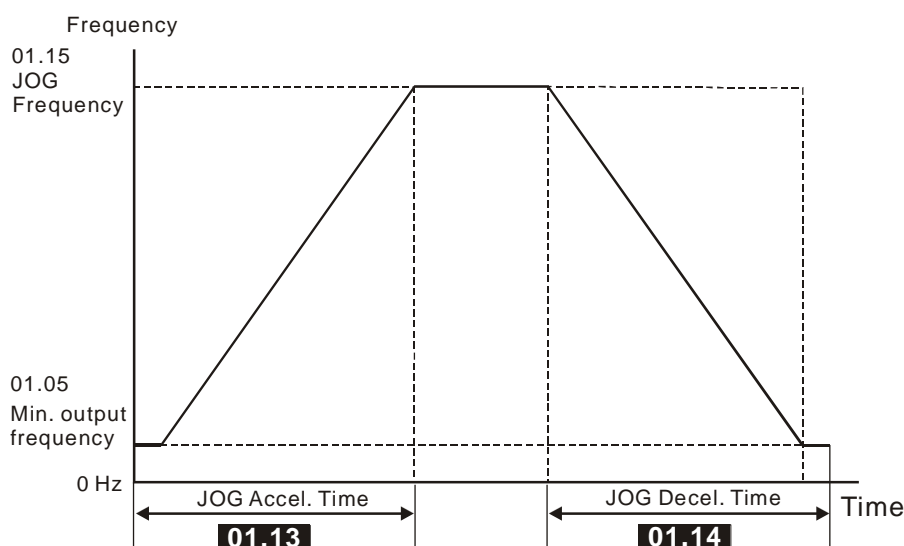

The definition of JOG Accel./Decel. Time

01.16 Auto-Acceleration / Auto-Deceleration Setting

Default: 0

Settings

- 0: Linear acceleration and deceleration
- 1: Auto-acceleration and linear deceleration
- 2: Linear acceleration and auto-deceleration
- 3: Auto-acceleration and auto-deceleration (set by loads)
- 4: Auto-acceleration and auto-deceleration (set by acceleration/ deceleration time setting)

With auto-acceleration and auto-deceleration, it is possible to reduce vibration and shocks during starting and stopping the load; the drive auto-detects the load torque and automatically accelerates from the fastest acceleration time and smoothest start-up current to the setting frequency. During deceleration, the drive automatically determines the loaded regenerative energy to steadily and smoothly stop the motor in the fastest deceleration time. When this

parameter is set to 4, the actual acceleration/deceleration time vary with the setting for Pr.01.09–Pr.01.12. Therefore, the actual acceleration/ deceleration time are equal to or greater than Pr.01.09–Pr.01.12.

- Using auto-acceleration and auto-deceleration can avoid complicated adjustment procedures. It does not stall during acceleration and does not need a brake resistor during deceleration to stop. It can also improve operation efficiency and save energy.

01.17 S-Curve Acceleration Time Setting

Default: 0.0 / 0.00

Settings 0.0–10.0 sec./ 0.00–10.00 sec.

01.18 S-Curve Deceleration Time Setting

Default: 0.0 / 0.00

Settings 0.0–10.0 sec./ 0.00–10.00 sec.

- Using an S-curve gives the smoothest transition between speed changes. The acceleration and deceleration curves can be adjusted to different degrees of S-acceleration and S-deceleration curves by setting Pr.01.17–01.18. When enabled, the drive produces a different acceleration and deceleration curve according to the acceleration and deceleration time. Set these parameters to 0.0 for linear acceleration/ deceleration.

- The following diagram shows that the original setting of the Acceleration and Deceleration Time is only for reference when you enable the S-curve. The acceleration/ deceleration time become longer as the setting value increases. Pr.01.17 must be smaller than Pr.01.09 or Pr.01.11; Pr.01.18 must be smaller than Pr.01.10 or Pr.01.12. Otherwise, the S-curve is invalid.

The total acceleration time = Pr.01.09 + Pr.01.17 or Pr.01.11 + Pr.01.17

The total deceleration time = Pr.01.10 + Pr.01.18 or Pr.01.12 + Pr.01.18

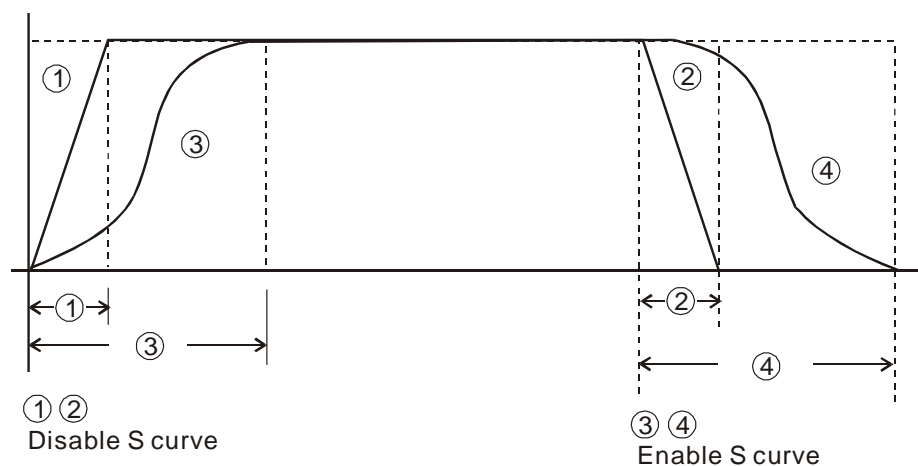

Acceleration/deceleration Characteristics

01.20 Simple Positioning Stop Frequency 0

Default: 0.00

Settings 0.00–400.00 Hz

01.21 Simple Positioning Stop Frequency 1

Default: 5.00

Settings 0.00–400.00 Hz

Chapter 4 Parameters | VFD-EL-W

↗	01.22	Simple Positioning Stop Frequency 2	Default: 10.00
		Settings 0.00–400.0 Hz	
↗	01.23	Simple Positioning Stop Frequency 3	Default: 20.00
		Settings 0.00–400.00 Hz	
↗	01.24	Simple Positioning Stop Frequency 4	Default: 30.00
		Settings 0.00–400.00 Hz	
↗	01.25	Simple Positioning Stop Frequency 5	Default: 40.00
		Settings 0.00–400.00 Hz	
↗	01.26	Simple Positioning Stop Frequency 6	Default: 50.00
		Settings 0.00–400.00 Hz	
↗	01.27	Simple Positioning Stop Frequency 7	Default: 60.00
		Settings 0.00–400.00 Hz	

📖 The setting for Pr.01.20–Pr.01.27 must follow the condition below:

📖 $Pr.01.20 \leq Pr.01.21 \leq Pr.01.22 \leq Pr.01.23 \leq Pr.01.24 \leq Pr.01.25 \leq Pr.01.26 \leq Pr.01.27$

📖 If any two of the parameters (between Pr.01.20–Pr.01.27) have the same stop frequency, set their Delay Time of Simple Positioning Stop to the same values.

↗	01.28	Simple Positioning Stop Delay Time 0	Default: 0.00
↗	01.29	Simple Positioning Stop Delay Time 1	
↗	01.30	Simple Positioning Stop Delay Time 2	
↗	01.31	Simple Positioning Stop Delay Time 3	
↗	01.32	Simple Positioning Stop Delay Time 4	
↗	01.33	Simple Positioning Stop Delay Time 5	
↗	01.34	Simple Positioning Stop Delay Time 6	
↗	01.35	Simple Positioning Stop Delay Time 7	
		Settings 0.00–600.00 sec.	

📖 Valid only when Pr.02.02 Motor Stop Method is set to 4: simple positioning stop.

📖 The settings 0–7 for Pr.01.20–Pr.01.27 must work with the settings 0–7 for Pr.01.28–Pr.01.35 and correspond to each other. For example, Pr.01.20 must work with Pr.01.28.

📖 The function of Pr.01.28–Pr.01.35 is simple positioning. Speed starts to decelerate after the time set at Pr.01.28–Pr.01.35 elapses. The accuracy of positioning is self-assessed by user.

$$S = n \times \left(\frac{t_x + (t_x + t_2)}{2} \right) \qquad n = f \times \frac{120}{p}$$

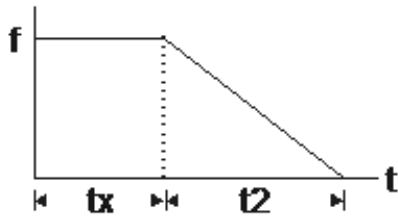

S: operation distance

(revolution)

n: rotation speed

(revolution/second)

t_x : delay time (second)

t_2 : deceleration time

(second)

n: rotation speed

(revolution/ minute)

p: number of poles in the motor

f: operation frequency (Hz)

The value of t_x in the equation above describes as below.

1.1 When the slope is negative ($t_1 > t_2$) 1.2 When the slope is positive ($t_1 < t_2$)

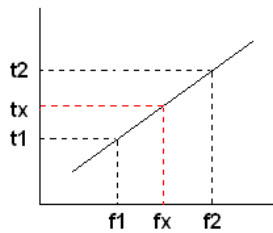
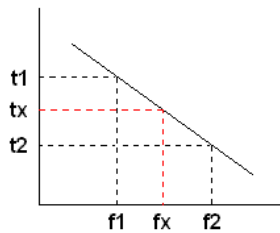

$$t_x = t_1 + \left(\frac{f_x - f_1}{f_2 - f_1} \right) \times (t_2 - t_1) = t_1 + \left(\frac{f_x - f_1}{10} \right) \times (t_2 - t_1)$$

$$t_x = t_2 - \left(\frac{f_2 - f_x}{f_2 - f_1} \right) \times (t_2 - t_1) = t_2 - \left(\frac{f_2 - f_x}{10} \right) \times (t_2 - t_1)$$

As shown in the figure below, assume that the radius of the four-pole motor is r and rotation speed is n (rpm).

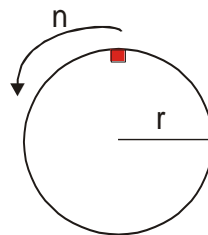

Example 1:

When the motor swivel table rotates at 50 Hz, and Pr.02.02 = 4 (Simple positioning stop; E.F.: Coast to stop), and Pr.01.26 = 50 Hz (Simple Positioning Stop Frequency 6), and its corresponding Pr.01.34 = 2 sec. (Simple Positioning Stop Delay Time 6), then the deceleration time from 50 Hz to 0 Hz is 10 seconds. After executing the stop command, Simple Positioning Stop activates, its rotation speed is $n = 120 \times 50 / 4$ (revolution / minute) = 25 (revolution / second)

The number of revolution of the swivel table = $(25 \times (2 + 12)) / 2 = 175$ (revolutions)

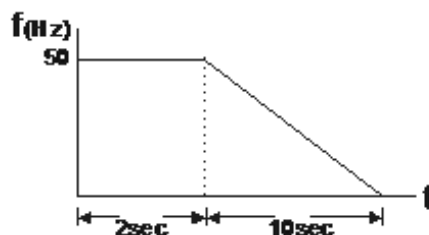

Therefore, the motor's operation distance after executing the stop command = number of revolutions \times circumference = $175 \times 2 \pi r$. It also means that the swivel table goes back to the top after 175 revolutions.

Chapter 4 Parameters | VFD-EL-W**Example 2:**

Assume that the motor swivel table rotates at 1.5 Hz, and Pr.01.22 = 10 Hz [Simple Positioning Stop Frequency 2], and Pr.01.30 = 10 sec. [Simple Positioning Stop Delay Time 2], then the deceleration time from 60 Hz to 0 Hz is 40 seconds.

The delay time at stop for 1.5 Hz is 1.5 second; the deceleration time from 1.5 Hz to 0 Hz is 1 second.

After executing the stop command, Simple Positioning Stop activates, its rotation speed is $n = 120 \times 1.5 / 4$ (revolution / minute) = 1.5/2(revolution / second)

The number of revolution of the swivel table = $(1.5/2 \times (1.5 + 2.5)) \div 2 = 1.5$ (revolutions)

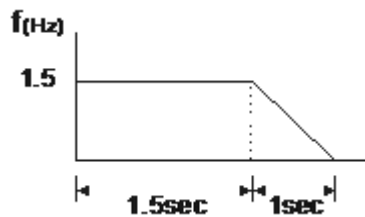

Therefore, the motor's operation distance after executing the stop command = number of revolutions \times circumference = $1.5 \times 2 \pi r$. It also means that the swivel table stops after running 1.5 revolutions.

02 Operation Method Parameters

✎ You can set this parameter during operation.

✎ 02.00 First Master Frequency Command Source

Default: 0

- Settings
- 0: Digital keypad or external terminals (up/ down function)
 - 1: External terminal AVI analog signal DC 0–10V
 - 2: External terminal ACI analog signal DC 4–20 mA
 - 3: RS-485 communication input
 - 4: Digital keypad potentiometer knob

✎ 02.09 Second Master Frequency Command Source

Default: 0

- Settings
- 0: Digital keypad or external terminals (up/ down function)
 - 1: External terminal AVI analog signal DC 0–10V
 - 2: External terminal ACI analog signal DC 4–20 mA
 - 3: RS-485 communication input
 - 4: Digital keypad potentiometer knob

 Sets the Master Frequency Command Source for the AC motor drive.

 Pr.02.09 is valid only when you set Pr.04.06, Pr.04.08 to 22. When setting 22 is activated, the frequency command source is the setting for Pr.02.09. You can only enable only one of the first master frequency command and second master frequency command sources at one time.

 When using the AVI terminal, pay attention to the ACI / AVI dip switch location on the AC motor drive. If you select ACI, the drive receives 4–20 mA analog current signal; if you select AVI, the drive receives 0–10 V_{DC} analog voltage signal.

✎ 02.01 Operation Command Source

Default: 0

- Settings
- 0: Digital keypad
 - 1: External terminals, STOP key is valid
 - 2: External terminals, STOP key is invalid
 - 3: RS-485 communication, STOP key is valid
 - 4: RS-485 communication, STOP key is invalid

 Sets the Operation Command Source for the AC motor drive.

✎ 02.10 First / Second Master Frequency Command Combination

Default: 0

- Settings
- 0: Disable
 - 1: First master frequency command + second master frequency command
 - 2: First master frequency command - second master frequency command

02.02 Stop Method

Default: 0

- Settings 0: Ramp to stop; E.F.: Coast to stop
 1: Coast to stop; E.F.: Coast to stop
 2: Ramp to stop; E.F.: Coast to stop
 3: Ramp to stop; E.F.: Coast to stop
 4: Simple positioning stop; E.F.: Coast to stop

 Determines how the motor is stopped when the AC motor drive receives the Stop command.

1. Ramp to stop: According to the set deceleration time, the AC motor drive decelerates to 0 Hz or the minimum output frequency (Pr.01.05), and then stop.
2. Coast to stop: According to the load inertia, the AC motor drive stops output immediately, and the motor coasts to stop.
3. The motor stop method is usually set depending on the load or the characteristics when the machine stops.
 - (1) Use “ramp to stop” for the safety of personnel or to prevent material from being wasted in applications where the motor must stop immediately after the drive stops. You must set the deceleration time accordingly.
 - (2) If idling is allowed or the load inertia is large, use “coast to stop”.

Example uses are blowers, pumps and punching machines.

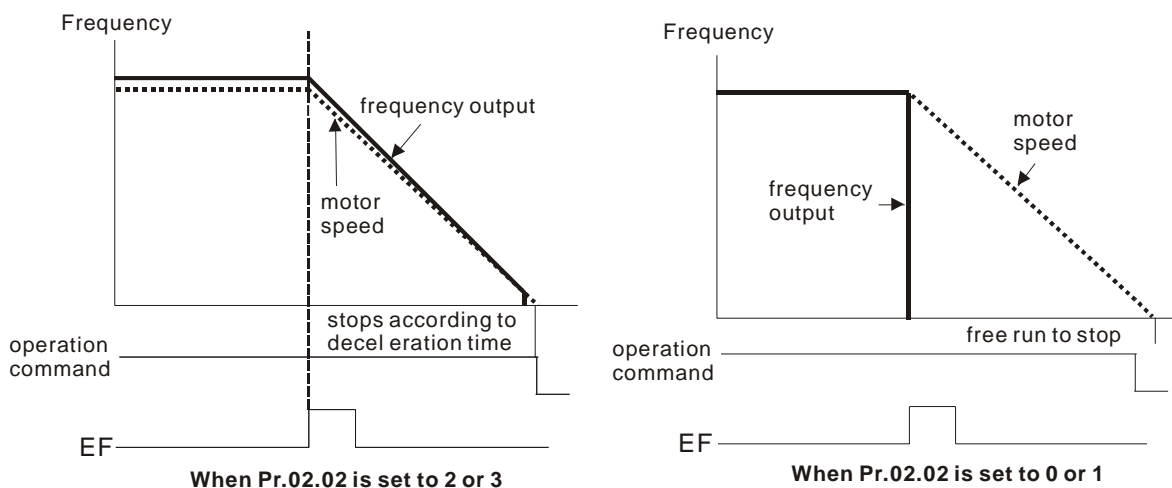
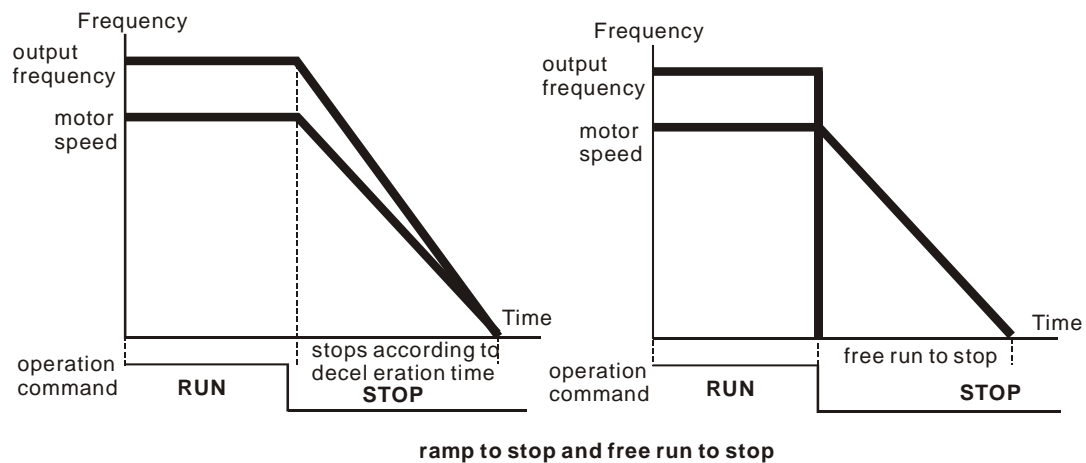

02.03 PWM Carrier Frequency Selection

Default: 8

Settings 2–12 kHz

 Determines the PWM carrier frequency for the AC motor drive.

Carrier Frequency	Acoustic Noise	Electromagnetic Noise or leakage current	Heat Dissipation	Current Wave
2kHz	Significant	Minimal	Minimal	Minimal
8kHz				
12kHz	Minimal	Significant	Significant	Significant

 From the table, you see that the PWM carrier frequency has significant influences on the electromagnetic noise, the AC motor drive heat dissipation, and the motor acoustic noise. Therefore, if the surrounding noise is greater than the motor noise, lower the carrier frequency to reduce the temperature rise. Although the motor has quiet operation in the higher carrier frequency, consider the entire wiring and interference.

 With default carrier frequency:

- (1) Take VFD007EL21W(-1) (need to install cooling fans) as an example, assume that the ambient temperature is 40°C, the drive output current must be controlled within 100% of the rated current. If the ambient temperature is 50°C, the drive output current should be within 80% of the rated current.
- (2) When model VFD007EL21W(-1) works without cooling fans, assume that the ambient temperature is 40°C, the drive output current must be controlled within 100% of the rated current. If the ambient temperature is 50°C, the drive output current should not exceed 80% of the rated current.

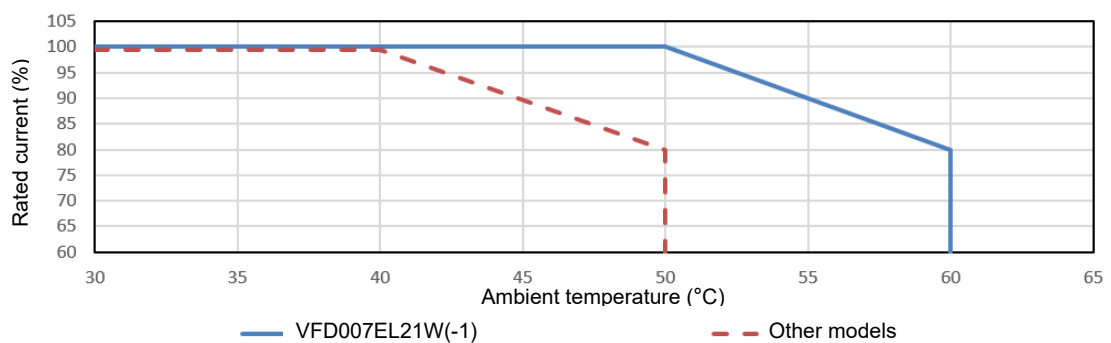

- (3) Take VFD007EL21W(-1) (need to install cooling fans) as an example, assume that the ambient temperature is 40°C and the default carrier frequency is 8 kHz, the drive output current reaches 100% of the rated current. If the carrier frequency is 12 kHz, the drive output current should be controlled within 80% of the rated current.
- (4) When model VFD007EL21W(-1) works without cooling fans, assume that the ambient temperature is 40°C and the default carrier frequency is 8 kHz, the drive output current reaches 100% of the rated current. If the carrier frequency is 12 kHz, the drive output current should be controlled within 80% of the rated current.

Chapter 4 Parameters | VFD-EL-W

- (5) For model VFD055EL43W, when that the ambient temperature is 50°C and the default carrier frequency is 4 kHz, the drive output current reaches 100% of the rated current. If the carrier frequency is 12 kHz, the drive output current should be controlled within 40% of the rated current.
- (6) When the ambient temperature is 25°C, the drive is installed independently and the carrier frequency is 12 kHz, the drive output current reaches 100% of the rated current.

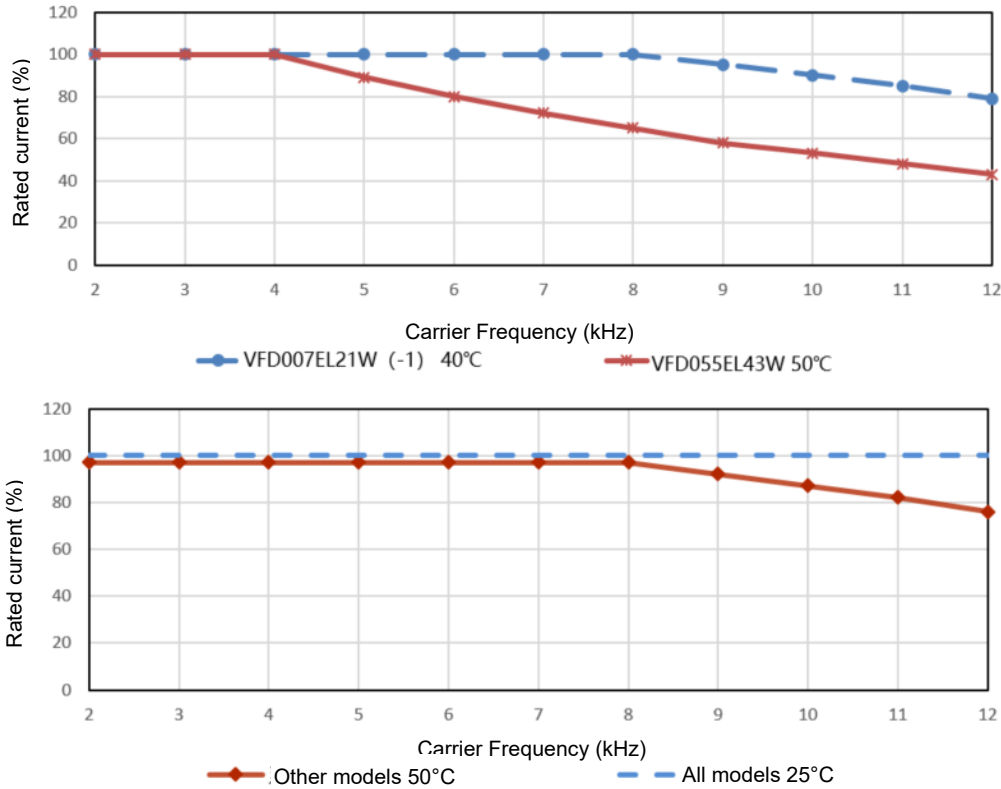

02.04 Motor Direction Control

Default: 0

- Settings
- 0: Enable Forward/ Reverse
 - 1: Disable reverse
 - 2: Disable forward

Avoid damages to the motor caused by mis-operation leading to the forward and reverse rotation of the motor.

02.05 Power-On and Run Command Source Changes Motor Drive Operation Control (external terminal only)

Default: 1

- Settings
- 0: Operates when power-on, remains current running status when the operation command is changed
 - 1: Do not run when power-on, remains current running status when the operation command is changed
 - 2: Operates when power-on, runs according to the new operation command immediately
 - 3: Do not run when power-on, runs according to the new operation command immediately

4: Runs when reset or power-on, changes operation command according to the external terminal status when the command source is 2-wire external terminal

As shown in the table below, when the operation command source is the external terminal, the operation command remains, and the AC motor drive power is ON, this parameter determines whether the AC motor drive changes the drive operating status or not according to the external terminal status.

Pr.02.05	Power ON	Operation Command Source Status
0	Run	Remains current operating status
1	Do not run	Remains current operating status
2	Run	Changes the operating status according to the new operation command
3	Do not run	Changes the operating status according to the new operation command
4	Run	Changes the operation command according to the external terminal

This parameter determines whether the AC motor drive receives the operation command or not when the operation command source is the external terminal, the operation command remains, and the AC motor drive power is ON.

0: The drive receives the operation command and runs immediately.

1: The drive does not receive the operation command. To make the motor run, cancel the operation command, and then input again.

4: Transient power failure restart with external terminal control. When the motor drive has an instantaneous power failure, the DC bus drops to Lv. If you send a command from the host computer while the DC bus is at Lv, and the operating command is still on conductive trigger, the drive can be restarted.

Power ON:

When the operation command source is the external terminal and the operation command is ON (MI1-DCM = closed), the AC motor drive operates according to Pr.02.05 after power is applied.

(1) Pr.02.05 = 0, 2 or 4: the drive runs immediately.

(2) Pr.02.05 = 1 or 3: the drive does not run. The AC motor drive remains stopped until the operation command is received after the previous operation command is canceled.

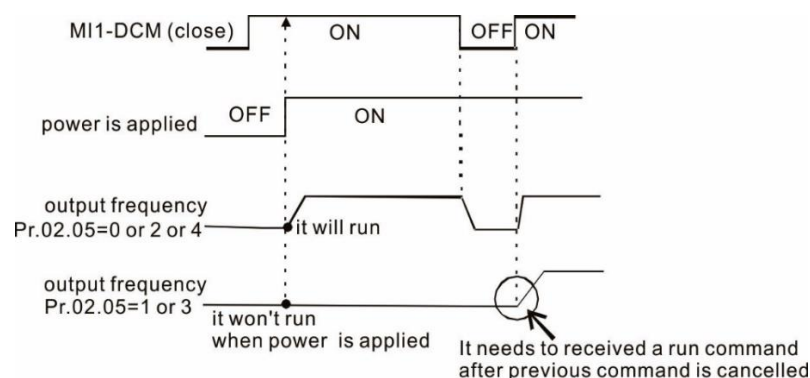

Chapter 4 Parameters | VFD-EL-W**Changing operation command source:**

Regardless of whether the AC motor drive runs or stops, when the new operation command source is the external terminals, and the terminal status (ON: RUN, OFF: STOP) are different with the drive current status, the AC motor drive operates according to Pr.02.05.

- (1) Pr.02.05 = 0 or 1: the status of the AC motor drive is not changed by the terminal status.
- (2) Pr.02.05 = 3 or 4: the status of the AC motor drive is changed by the terminal status.

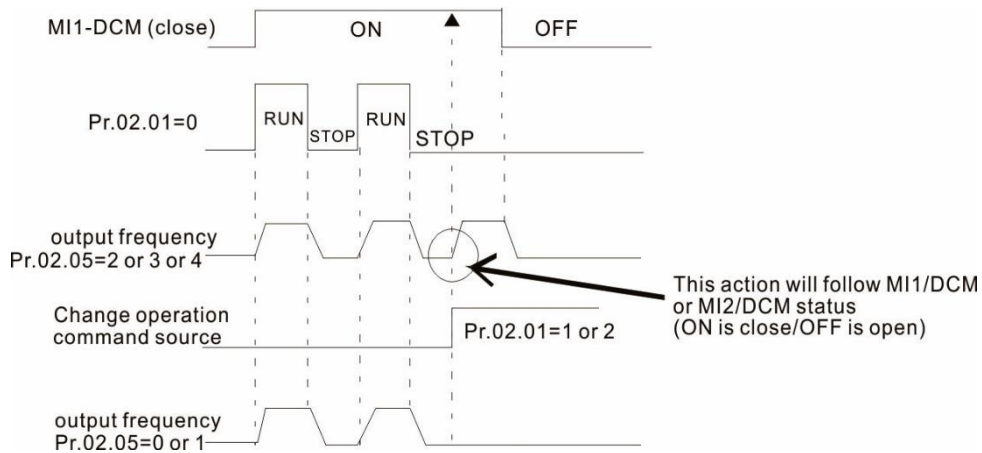

When you set Pr.02.05 = 1 or 3, it does not guarantee that the drive will never run. Be careful when using this function because the switch may bounce due to mechanical vibration or defective switch parts.

02.06 ACI Loss

Default: 0

- Settings
- 0: Decelerates to 0 Hz
 - 1: Stop immediately and display AErr
 - 2: Continue operation at the last frequency
 - 3: Operates at the frequency of Pr.02.11

Determines the action when ACI analog input (4–20 mA) is loss.

1: Display the warning message “AErr” on the keypad when the ACI signal is lost and execute the Pr.02.06 setting. When the ACI signal is recovered, the warning message automatically disappears. Press “STOP/RESET” key to clear the warning message.

02.07 External Terminal Up/Down Key Mode Selection

Default: 0

- Settings
- 0: By Up/ Down key
 - 1: By acceleration/ deceleration time
 - 2: By constant speed (Pr.02.08)
 - 3: By pulse (Pr.02.08)

02.08 External Terminal Speed of the Up/ Down Key

Default: 0.01

- Settings 0.01–10.00 Hz/2ms

Defines how the frequency command increases or decreases when the multi-function input terminals (Pr.04.06–04.08) are set to 10 (Up Command) or 11 (Down Command).

Pr.02.07 = 0: Use the Up/ Down keys on the digital keypad to increase or decrease the frequency command.

Pr.02.07 = 1: The increasing or decreasing Frequency command (F) operates according to the setting for acceleration or deceleration time, only valid during operation.

Pr.02.07 = 2: Increase and decrease the frequency command according to the setting for Pr.02.08.

Pr.02.07 = 3: Increase and decrease the frequency command according to the setting for Pr.02.08 (unit: pulse input). Every ON after OFF is regarded as one input pulse.

02.11 Keypad Frequency Command

Default: 60.00

Settings 0.00–400.0 Hz

 Sets the frequency command or reads the keypad frequency command.

02.12 Communication Frequency Command

Default: 60.00

Settings 0.00–400.00 Hz

 Sets the frequency command or reads the communication frequency command.

02.13 Frequency Command Saving Mode

Default: 0

Settings 0: Save the frequency before power-off

1: Only save the keypad frequency command before power-off

2: Only save the communication frequency command before power-off

 Determines whether to save the set frequency before power-off.

02.14 Initial Frequency Command Mode at Stop

Default: 0

Settings 0: Use current Frequency command

1: Use zero Frequency command

2: Refer to Pr.02.15 to set up

02.15 Initial Frequency Command Setting at Stop

Default: 60.00

Settings 0.00–400.0 Hz

 Pr.02.14 and Pr.02.15 determine the initial frequency command at STOP.

Pr.02.14 = 0: Sets the initial frequency command as current frequency command at STOP.

Pr.02.14 = 1: The initial frequency command returns to zero at STOP.

Pr.02.14 = 2: The initial frequency command operates according the setting for Pr.02.15 at STOP.

02.16 Frequency Command Source Display

Default: Read only

- Settings
- 1: bit0 = 1: First frequency command source (Pr.02.00)
 - 2: bit1 = 1: Second frequency command source (Pr.02.09)
 - 4: bit2 = 1: Set by external MI terminal

 This parameter is read only, you can read the frequency command source from this parameter.

02.17 Operation Command Source Display

Default: Read only

- Settings
- 1: bit0 = 1: Digital keypad
 - 2: bit1 = 1: RS-485
 - 4: bit2 = 1: External Terminal
 - 8: bit3 = 1: External MI terminals

 This parameter is read only, you can read the operation command source from this parameter.

02.18 User-defined Value Setting

Default: 0

- Settings 0–Pr.00.13

 Reads and writes the user-defined value settings. Changes the operation frequency when Pr.00.13 is not set to 0 and frequency source is from communication.

02.19 User-defined Value

Default: 0

- Settings Read only

 For example, assume that the frequency source is the first frequency + the second frequency, the first frequency command source is digital keypad and the second frequency source is AVI, set the user-defined value 1 as 180.0 (Pr.00.13 = 1800, Pr.00.14 = 1).
 When AVI = 2V, the user-defined value is 36.0 [$180.0 \div (2V/10V)$], and the frequency is 12.0 Hz [$36.0 \div (180.0/60.0)$].
 When Pr.02.18 = 30.0, the frequency is 10.0 Hz [$30.0 \div (60.0/180.0)$].
 At this time, the keypad displays 66.0 (36.0+30.0), and the output frequency is 22.0 Hz (12.0+10.0). If you read the values by using the communication address, the values display as follows: 2102H and 2103H are 22.0 Hz; 0212H (Pr.02.18) is 30.0 Hz; 0213H (Pr.02.19) is 66.0.

03 Output Function Parameters

✎ You can set this parameter during operation.

03.00 Multi-Function Output Relay

Default: 8

Settings 0–23

Summary of Function Settings

ID*	Functions	Descriptions
0	No function	Output terminal with no function
1	Indication during RUN	This contact is closed when the drive is ready or RUN command is ON.
2	Indication of Master Frequency Reached	This contact is closed when output frequency of drive reaches to the setting frequency.
3	Indication at zero speed	This contact is closed when the drive output frequency is smaller than the start-up frequency.
4	Over-torque detection	This contact is closed when the drive detects over-torque. Pr.06.04 sets the over-torque detection level, and Pr.06.05 sets the over-torque detection time.
5	Base Block (B.B) indication	This contact is closed when external interrupt (B.B.) occurs in the drive and stops outputting.
6	Low-voltage indication	This contact is closed when the drive detects that the input voltage is too low.
7	Operation mode indication	This contact is closed when the drive operation command source is external terminals.
8	Malfunction indication	This contact is closed when fault occurs. (oc, ov, oH1, oL, oL1, EF, cF3.0–5, HPF1, 2, 4, ocA, ocd, ocn)
9	Desired frequency reached	This contact is closed when the desired frequency (Pr.03.02) is reached.
10	Terminal count value reached	When the drive executes external counter, this contact is closed if the count value is equal to the setting value for Pr.03.05.
11	Terminal count value reached	When the drive executes external counter, this contact is closed if the count value is equal to the setting value for Pr.03.06.
12	Over-voltage stall prevention	This contact is closed when over-voltage stall prevention is ON.
13	Over-current stall prevention	This contact is closed when the over-current stall prevention is ON.
14	IGBT over-heating warning	This contact is closed when IGBT overheats to prevent the drive from shutting down due to overheating. > 85°C ON, < 80°C OFF
15	Over-voltage	This contact is closed when the drive detects that the DC bus voltage is too high.
16	PID feedback error	This contact is closed when the PID feedback signal error is detected. (Refer to Pr.10.08, Pr.10.12)
17	Forward command	This contact is closed when the drive operates in a forward direction.
18	Reverse command	This contact is closed when the drive operates in a reverse direction.

Chapter 4 Parameters | VFD-EL-W

ID*	Functions	Descriptions
19	Zero speed including STOP	Zero speed output signal (including STOP)
20	Warning indication	This contact is closed when warning occurs. (CExx, AUE, FbE, SAve)
21	Mechanical brake control	This contact is closed when the output frequency \geq Pr.03.11 setting value When the drive stops and the output frequency \leq Pr.03.12 setting value, this contact is opened.
22	Drive is ready	This contact is closed when the drive is ready.
23	Indication of multi-pump system error (only Master)	When all AC motor drives in multi-pump system are failed, the contact "closed" means it is ON or in low potential.

※ "Closed" means the relay is ON or low voltage.

03.02 Desired Frequency Reached

Default: 0.00

Settings 0.00–400.0 Hz

Once the output frequency reaches the desired frequency, if the corresponding multi-function output terminal is set to 9 (Pr.03.00–Pr.03.01), this multi-function output terminal is "closed".

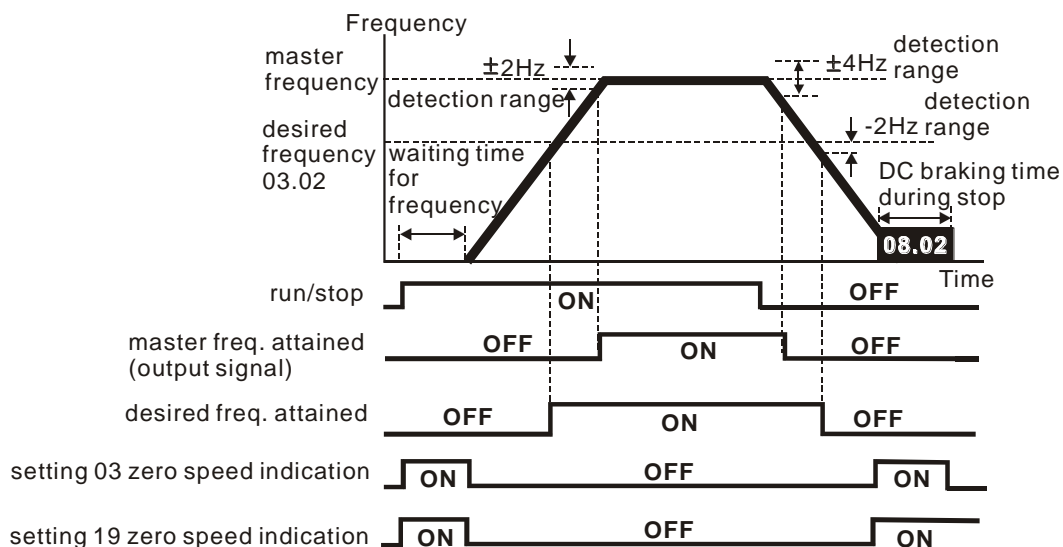

output timing chart of multiple function terminals when setting to frequency attained or zero speed indication

03.01	Reserved
03.03	Reserved
03.04	Reserved
03.05	Count Value Reached

Default: 0

Settings 0–9999

Sets the count value of the internal counter. You can use the external multi-function input terminals on the control terminals to trigger the counter. When the count reaches the setting value, the specified output terminal activates by setting one of the multi-function input terminals (the count value resets after reaching the setting for Pr.03.05).

NOTE:

When the display shows c555, the drive has counted 555 times. If the display shows c555•, it means that the actual counter value is between 5,550 and 5,559.

03.06 Preliminary Count Value Reached

Default: 0

Settings 0–9999

When the count value counts from c1 to reach this value, the corresponding multi-function output terminal is activated. You can use this parameter as the end of counting to make the drive run from the low speed to stop.

The timing diagram shows as follows:

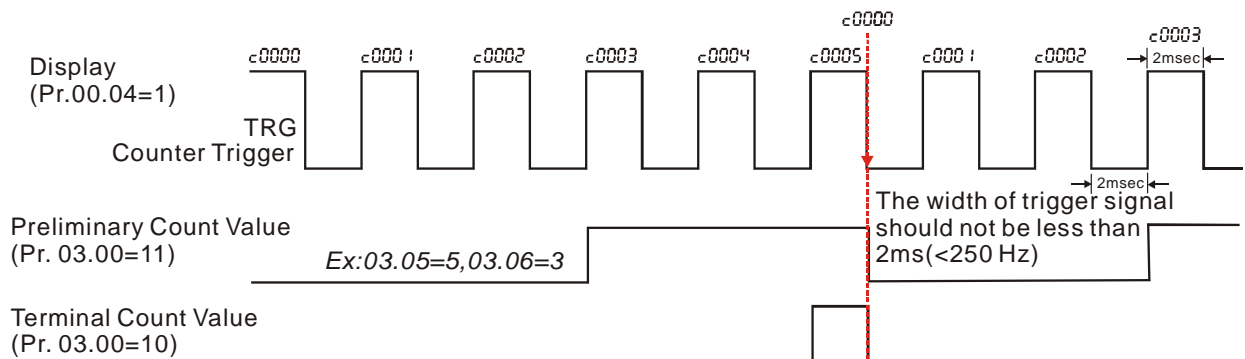
**03.07 EF Activates when the Terminal Count Value Reached**

Default: 0

Settings 0: Terminal count value reached, no EF displays
1: Terminal count value reached, EF activates

When Pr.03.07 = 1: the drive stops and shows "EF" message when the counter value reached, and continues to run when the fault is RESET.

03.08 Fan Cooling Control

Default: 0

Settings 0: Fan is always ON
1: Fan is OFF after the AC motor drive stops for one minute.
2: Fan is ON when the AC motor drive runs; fan is OFF when the AC motor drive stops
3: Fan turns ON when temperature (IGBT) reaches (60°C ON, 40°C OFF)
4: Fan is ON when the AC motor drive runs; fan is OFF when the AC motor drive stops. Fan is in stand-by mode at zero speed.

Determines the operation mode of the cooling fan.

This parameter is only valid for models with cooling fan.

03.09 Reserved**03.10 Reserved**

03.11 Mechanical Brake Release Frequency

Default: 0.00

Settings 0.00–20.00 Hz

03.12 Mechanical Brake Active Frequency

Default: 0.00

Settings 0.00–20.00 Hz

- 📖 Set the closing (ON) and breaking frequency of the output terminal (Relay) corresponding to the control parameter 03.00 multi-function output terminal 21: Mechanical brake control.

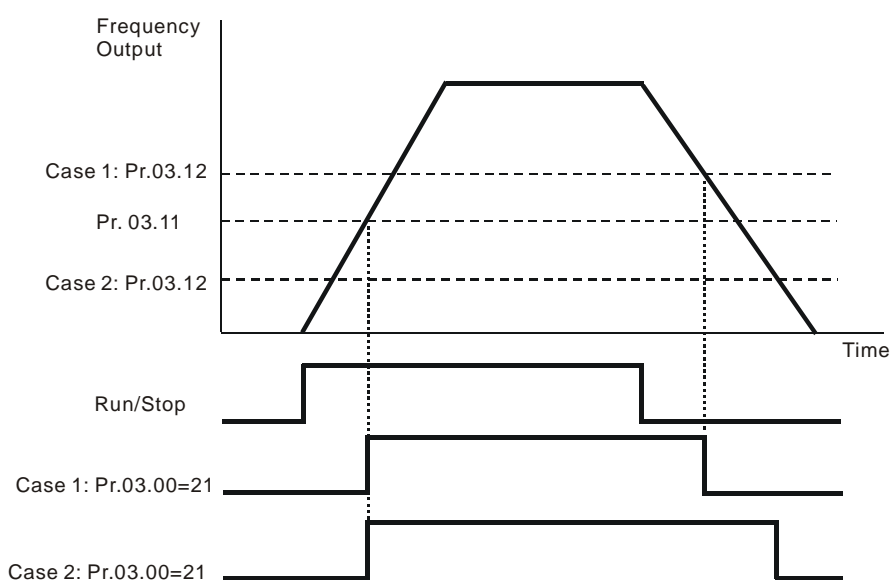

- 📖 Pr.03.00 multi-function output terminal 21: Mechanical brake control: When the output frequency reaches Pr.03.11 (Mechanical brake release frequency), this terminal is closed (ON); when the output frequency reaches Pr.03.12 (Mechanical brake active frequency), this terminal is OFF.

03.13 Display the Status of Multi-function Output Terminal

Default: Read only

Settings Read only

- 📖 The multi-function output terminal is falling-edge triggered, Pr.03.13 displays 1 when the relay is OFF.

04 Input Function Parameters

✎ You can set this parameter during operation.

✎ 04.00 Keypad Potentiometer Bias

Default: 0.00

Settings 0.0–100.0%

✎ 04.01 Keypad Potentiometer Bias Direction

Default: 0

Settings 0: Positive bias
1: Negative bias

✎ 04.02 Keypad Potentiometer Gain

Default: 100.0

Settings 0.1–200.0%

04.03 Keypad Potentiometer Negative Bias with Reverse Motion

Default: 0

Settings 0: Positive bias only
1: Negative bias with reverse command

📖 Pr.04.00–04.03 are applied to set and adjust the frequency by the digital keypad knob signal. The knob of the digital keypad is not connected externally, but the knob voltage is required when setting parameters. Refer to the following example for further explanation.

📖 As shown in the figure below, turn the digital keypad knob to the position shown on the left represents the min. position corresponding to the minimum voltage 0 V_{DC} of the knob; turn it to the position shown on the right represents the Max. position corresponding to the maximum voltage 5 V_{DC} of the knob.

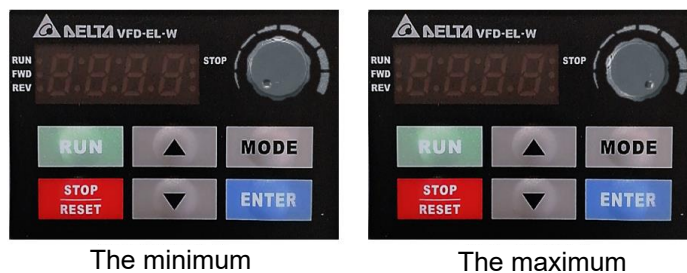

Example 1:

Set Pr.02.00 to 4 and remain Pr.04.00–04.03 as default setting values, then you can use the digital keypad knob to set the corresponding main frequency command.

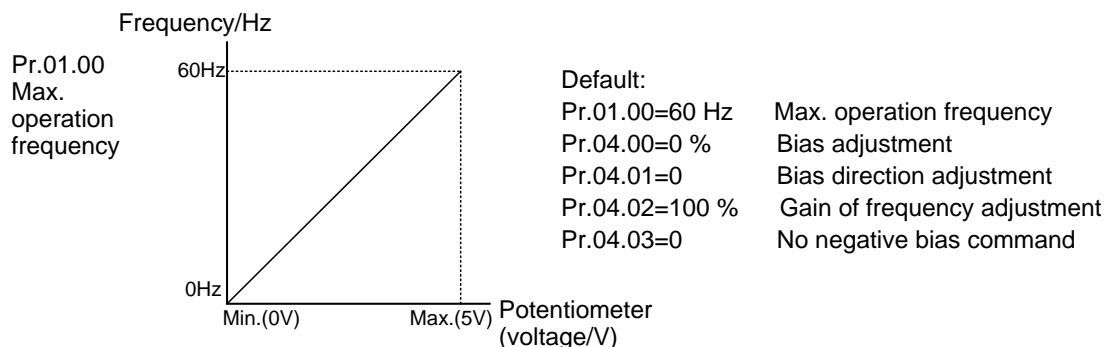

Chapter 4 Parameters | VFD-EL-W

Example 2:

If you want the corresponded minimum value to be 12 Hz when the keypad potentiometer is turned to the minimum position (Min.), you need to adjust other frequencies manually. From the diagram below, you can see that the correspondence between the keypad potentiometer (voltage) and setting frequency has been changed from 0–5 V (min.–max.) / 0–60 Hz to 0–4 V / 0–60 Hz. Therefore, the 4 V and above from the keypad potentiometer all correspond to 60 Hz. To use the full potentiometer range, refer to Example 3.

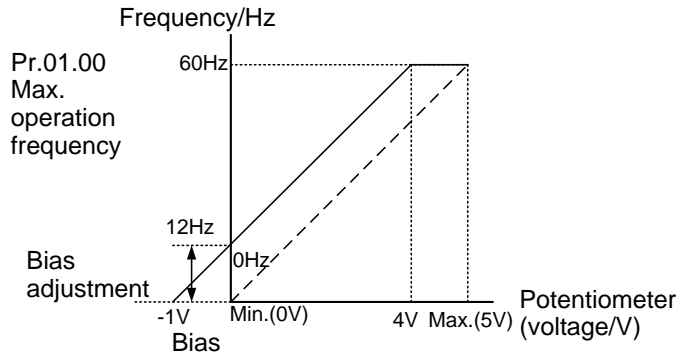

Default:

Pr.01.00=60 Hz	Max. operation frequency
Pr.04.00=20 %	Bias adjustment
Pr.04.01=0	Bias direction adjustment
Pr.04.02=100 %	Gain of frequency adjustment
Pr.04.03=0	No negative bias command

To count the bias (See α in the formula)

$$\frac{60-0 \text{ Hz}}{5\text{V}} = \frac{12-0 \text{ Hz}}{\alpha\text{V}} \rightarrow \alpha = 1\text{V}$$

$$\therefore \text{Pr.04.00} = \frac{1\text{V}}{5\text{V}} \times 100 \% = 20 \%$$

Example 3:

As shown in this example, the keypad potentiometer can be used for all ranges of 0–5 V / 0–60 Hz settings. This increases flexibility.

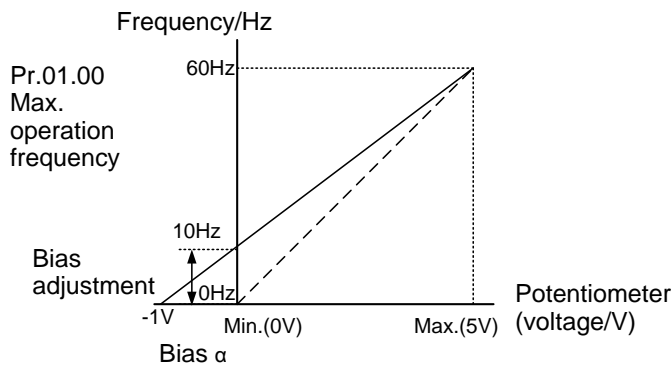

Default:

Pr.01.00=60 Hz	Max. operation frequency
Pr.04.00=20 %	Bias adjustment
Pr.04.01=0	Bias direction adjustment
Pr.04.02=83.3 %	Gain of frequency adjustment
Pr.04.03=0	No negative bias command

To count the bias (See α in the formula)

$$\frac{60-10 \text{ Hz}}{5\text{V}} = \frac{10-0 \text{ Hz}}{\alpha\text{V}} \rightarrow \alpha = 1\text{V}$$

$$\therefore \text{Pr.04.00} = \frac{1\text{V}}{5\text{V}} \times 100 \% = 20 \%$$

To count the gain value

$$\text{Pr.04.02} = \frac{5\text{V}}{[5-(-1)]\text{V}} \times 100 \% = 83.3 \%$$

Example 4:

This example shows how to use the first half range 0–2.5 V (min.–1/2 × max.) from the keypad potentiometer to set 0–60 Hz frequency settings. You can achieve the same results by either adjusting Pr.04.02 gain or setting Pr.01.00 to 120 Hz.

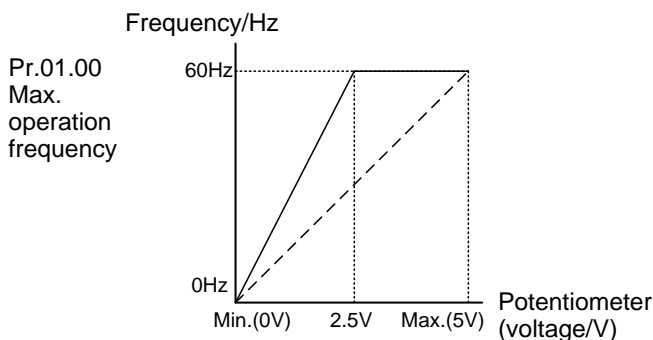

Default:

Pr.01.00=60 Hz	Max. operation frequency
Pr.04.00=0.0 %	Bias adjustment
Pr.04.01=0	Bias direction adjustment
Pr.04.02=200 %	Gain of frequency adjustment
Pr.04.03=0	No negative bias command

To count the gain value

$$\text{Pr.04.02} = \frac{5\text{V}}{(5-2.5)\text{V}} \times 100 \% = 200 \%$$

Example 5:

Using negative bias to set the frequency greatly reduces the noise interference. In a noisy environment, do NOT use signals less than 1V to set the drive's operation frequency.

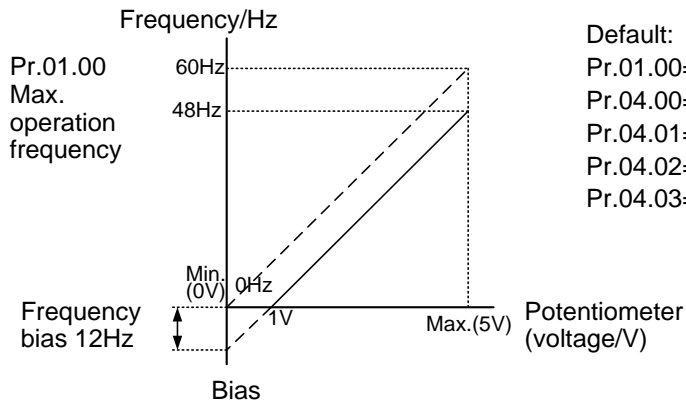

- Default:
- Pr.01.00=60 Hz Max. operation frequency
 - Pr.04.00=20.0 % Bias adjustment
 - Pr.04.01=1 Bias direction adjustment
 - Pr.04.02=100 % Gain of frequency adjustment
 - Pr.04.03=0 No negative bias command

Example 6:

This example is an extension application of Example 5. In addition, it uses the gain correction to set to the maximum operating frequency. This type of application is extremely extensive, you can apply it flexibly.

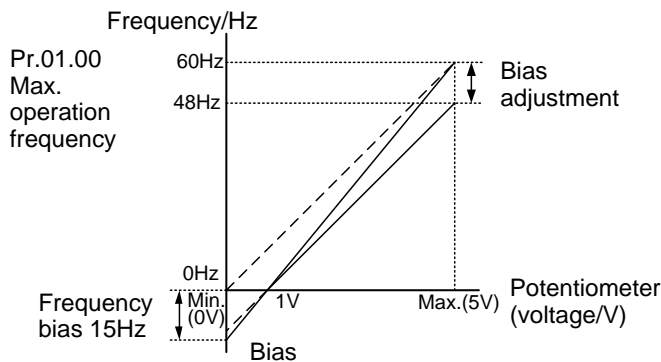

- Default:
- Pr.01.00=60 Hz Max. operation frequency
 - Pr.04.00=20.0 % Bias adjustment
 - Pr.04.01=1 Bias direction adjustment
 - Pr.04.02=125 % Gain of frequency adjustment
 - Pr.04.03=0 No negative bias command

To count the gain value

$$\text{Pr.04.02} = \frac{5V}{(5-1)V} \times 100\% = 125\%$$

Example 7:

This example is the culmination of all potentiometer applications. With the application of forward and reverse rotation areas, it can be easily combined with the system to make various complex applications. When this application is set, the forward and reverse commands of the external terminals will automatically fail, pay extra attention.

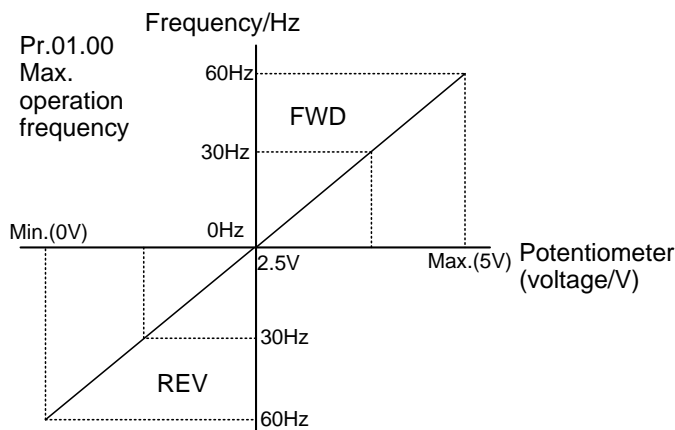

- Default:
- Pr.01.00=60 Hz Max. operation frequency
 - Pr.04.00=50.0 % Bias adjustment
 - Pr.04.01=1 Bias direction adjustment
 - Pr.04.02=200 % Gain of frequency adjustment
 - Pr.04.03=1 No negative bias command

To count the bias (See α in the formula)

$$\frac{60 - (-60)\text{Hz}}{5V} = \frac{60 - 0\text{Hz}}{\alpha V} \rightarrow \alpha = 2.5V$$

$$\therefore \text{Pr.04.00} = \frac{2.5V}{5V} \times 100\% = 50\%$$

To count the gain value

$$\text{Pr.04.02} = \frac{5V}{[5 - (2.5)]V} \times 100\% = 200\%$$

Chapter 4 Parameters | VFD-EL-W

Example 8:

This example uses negative slope.

The rotate direction of this application cannot be changed, and the drive can only operate in a reverse direction. Pay extra attention when using this application.

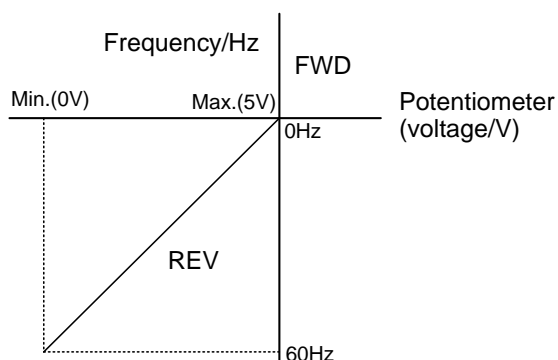

Default:

Pr.01.00=60 Hz

Pr.04.00=100 %

Pr.04.01=1

Pr.04.02=100 %

Pr.04.03=1

Max. operation frequency

Bias adjustment

Bias direction adjustment

Gain of frequency adjustment

No negative bias command

04.11 Minimum AVI Input Voltage

Default: 0.0

Settings 0.0–10.0 V

04.12 Minimum AVI Input Frequency

Default: 0.0

Settings 0.0–100.0% [100% corresponds to Fmax (Pr.01.00)]

04.13 Maximum AVI Input Voltage

Default: 10.0

Settings 0.0–10.0 V

04.14 Maximum AVI Input Frequency

Default: 100.0

Settings 0.0–100.0% [100% corresponds to Fmax (Pr.01.00)]

04.15 Minimum ACI Input Current

Default: 4.0

Settings 0.0–20.0 mA

04.16 Minimum ACI Input Frequency

Default: 0.0

Settings 0.0–100.0% [100% corresponds to Fmax (Pr.01.00)]

04.17 Maximum ACI Input Current

Default: 20.0

Settings 0.0–20.0 mA

04.18 Maximum ACI Input Frequency

Default: 100.0

Settings 0.0–100.0% [100% corresponds to Fmax (Pr.01.00)]

 Sets the corresponding function between analog input value and maximum operating frequency (Pr.01.00) (used in open-loop control), as shown in the figure below.

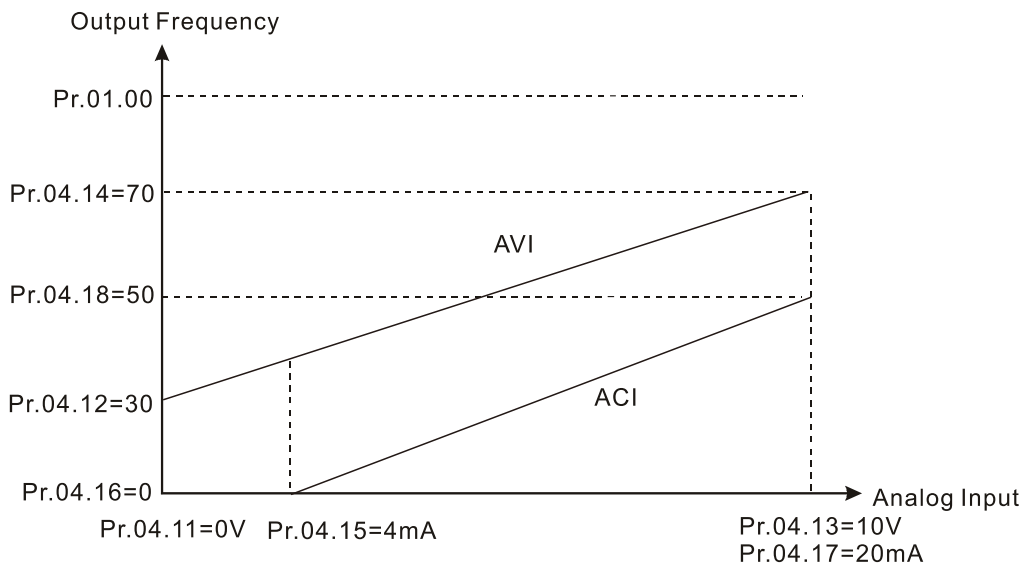
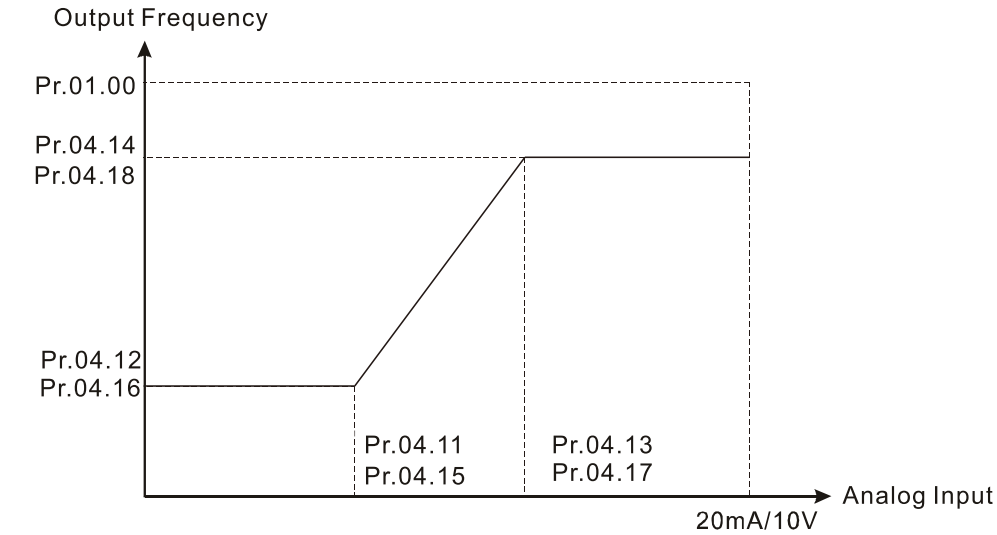

04.04 MI Terminal Start/ Stop Method and Multi-Function Input Selection

Default: 0

Settings Mode 1: Pr.04.19 = 0

0: MI1 activates (FWD lights ON) / stops

Mode 2: Pr.04.19 = 1

0: Two-wire (1) MI1, MI2

1: Two-wire (2) MI1, MI2

3: Three-wire MI1, MI2 and MI3

- 📖 Pr.04.19 determines the setting range and function of this parameter.
- 📖 Mode 1 Pr.04.19 = 0: MI1 controls activation or stop; MI2, MI3 and MI4 are set as multi-function terminals.
- 📖 Mode 2 Pr.04.19 = 1: two-wire (1)/ two-wire (2) MI1 and MI2 are used for start-up/ stop and forward/ reverse control; MI3 and MI4 are set as multi-function terminals; three-wire (MI1, MI2 and MI3) are used for start-up/ stop and forward/reverse control; MI4 is set as the multi-function terminal.

Chapter 4 Parameters | VFD-EL-W

Pr.04.19 Setting	Pr.04.04 Setting	External Terminal Control Circuits
Mode 1 Pr.04.19 = 0	Pr.04.04 = 0 Single-wire operation control FWD / STOP	
Mode 2 Pr.04.19 = 1	Pr.04.04 = 0 Two-wire operation control FWD / STOP, REV / STOP	
Mode 2 Pr.04.19 = 1	Pr.04.04 = 1 Two-wire operation control RUN / STOP, REV / FWD	
	Pr.04.04 = 2 Three-wire Operation Control	

04.19 MI Terminal Control Mode Selection

Default: 0

Settings 0: Mode 1 (MI1: Start/ Stop, MI2 and MI3: multi-function input terminals)

1: Mode 2 (MI1, MI2 and MI3 support two-wire/ three-wire start-up)

MI terminal control mode is affected by the setting for Pr.04.19 and divided into two modes.

Mode 1: MI1 is Start/ Stop terminal; MI2 and MI3 are multi-function input terminals

Mode 2: MI1, MI2 and MI3 support two-wire/ three-wire start-up.

04.05 Reserved**04.06** Start/ Stop or Multi-Function Input Command 1 (MI2)

Default: 1

04.07 Start/ Stop or Multi-Function Input Command 2 (MI3)

Default: 2

04.08 Multi-function Input Command 4 (MI4)

Default: 3

Settings 0–25

Use this parameter to set the function of multi-function input terminals.

Summary of Function Settings

ID*	Functions	Descriptions
0	No function	This setting disables the terminal function, the drive does not take any action even when there is a signal input. Set the unused terminal to 0 to prevent mis-connection or malfunction.
1	Multi-step speed command 1	Use these three terminals to set the seven-step speed operation. There are nine step speed frequencies (including Master Frequency and Jog Frequency) available.
2	Multi-step speed command 2	
3	Multi-step speed command 3	
4	Reserved	
5	Reset	Use this terminal to reset the drive after clearing a drive fault.
6	Acceleration / deceleration speed inhibit	<p>When you enable this function, the drive stops acceleration or deceleration immediately. The AC motor drive resumes from the inhibit point once this function is disabled.</p>
7	1st and 2nd acceleration / deceleration time selection	<p>You can select the acceleration and deceleration time of the drive with this function, or from the digital status of the terminals; there are two acceleration and deceleration selections.</p>
8	JOG operation	The JOG operation executes when the drive stops completely. While running, you can still change the operation direction; and the STOP key on the keypad is valid. When the external terminal is OFF, the motor stops in the JOG deceleration time. Refer to Pr.01.13–01.15 for details.

Chapter 4 Parameters | VFD-EL-W



ID*	Functions	Descriptions
9	External interrupt B.B. input (Base Block)	<p>ON: the output of the drive stops immediately and the motor is in free run status. When Base Block control is deactivated, the drive starts its speed search function and synchronizes with the motor speed, and then accelerates to the set frequency. Even if the motor has completely stopped after the Base Block, it executes the speed tracking as soon as the function is OFF. (NOTE: bb: Base block) (Refer to descriptions of Pr.08.06–08.07)</p>
10	Digital up command	ON: the frequency of the drive increases or decreases by one unit. If this function remains ON continuously, the frequency increases or decreases according to Pr.02.07 / Pr.02.08. The Digital up command and Digital down command are the same as the up/down key on the digital keypad, the only difference is that they cannot be used to change parameter settings. These two functions are only valid when the frequency command source is digital keypad (Pr.02.00/ Pr.02.09 = 0).
11	Digital down command	ON: the frequency of the drive increases or decreases by one unit. If this function remains ON continuously, the frequency increases or decreases according to Pr.02.07 / Pr.02.08. The Digital up command and Digital down command are the same as the up/down key on the digital keypad, the only difference is that they cannot be used to change parameter settings. These two functions are only valid when the frequency command source is digital keypad (Pr.02.00/ Pr.02.09 = 0).
12	Counter triggered signal input	Uses external signals such as connecting ON/OFF switch, lightning sensor, etc., to trigger the counter. You can also use signals of the multi-function output terminal (counter reached, desired counter reached) to control the applications that based on the counter. For example: winding machine, packing machine. (Refer to Pr.03.05 and Pr.03.06 for details.)
13	Clear the counter	ON: the current counter value is cleared and displays c0. The drive counts up when this function is disabled.
14	External Fault (EF) input	When the drive receives status change from the EF terminal, it stops output immediately and shows EF on the digital keypad. The drive keeps running until the external fault is cleared after you press RESET on the keypad (EF: External Fault). (EF: External Fault)
15	PID Control Disabled	ON: the PID control function is disabled.
16	Output stop	AC motor drive stops output and the motor coasts if one of these settings is enabled. If the status of terminal is changed, AC motor drive restarts from 0 Hz.

ID*	Functions	Descriptions
17	Parameter lock	ON: all parameters are read as 0. Change the terminal status to OFF to read the parameter settings.
18	Operation command selection (Pr.02.01): External terminals	ON: operation command source is external terminals OFF: operation command source is Pr.02.01 setting (NOTE: When 18, 19 and 20 are ON at the same time, the priority of operation command source is 18 > 19 > 20.)
19	Operation command selection (Pr.02.01): Digital keypad	ON: operation command source is digital keypad OFF: operation command source is Pr.02.01 setting (NOTE: When 18, 19 and 20 are ON at the same time, the priority of operation command source is 18 > 19 > 20.)
20	Operation command selection (Pr.02.01): RS-485	ON: operation command source is communication (RS-485). OFF: operation command source is Pr.02.01 setting (NOTE: When 18, 19 and 20 are ON at the same time, the priority of operation command source is 18 > 19 > 20.)
21	FWD / REV	ON: Reverse; OFF: Forward You cannot change the direction through the up/down keys on the keypad.
22	Second frequency command source	ON: Pr.02.09 setting is valid. It is used to switch the first/ second frequency command and the operation command source.
23	Simple positioning FWD stop limit	When the motor receives this signal while running in a forward direction, it stops running forward.
24	Simple positioning REV stop limit	When the motor receives this signal while running in a reverse direction, it stops running reverse.
25	25: Multi-pump manual/ auto switch	When this function is enabled, switch to HAND or AUTO mode through this terminal.
29	Prohibit Write EEPROM Function	ON: determines whether to enable the Prohibit write EEPROM function

04.09 Status Selection of Multi-function Input Terminal

Default: 0

Settings 0–63

-  Sets the contact status of external multi-function input terminals MI2–MI4 to be normally open (N.O.) or normally closed (N.C.) according to the start-up / stop mode (Pr.04.19 and Pr.04.04).
-  When the start-up/ stop mode is single-wired (Pr.04.04 = 0, Pr.04.19 = 0), MI1 setting is invalid; when the start-up/ stop mode is two-wired (Pr.04.04 = 0 or 1, Pr.04.19 = 1), MI2 setting is invalid; when the start-up/ stop mode is three-wired (Pr.04.04 = 2, Pr.04.19 = 1), MI2 and MI3 settings are invalid. See the table below for details.

Chapter 4 Parameters | VFD-EL-W

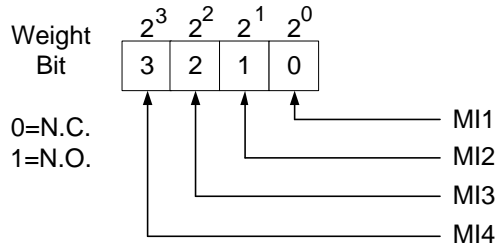

Start-up/ Stop Mode		MI4	MI3	MI2	MI1	MI Terminal Status Setting		
Mode	Pr.04.19	Pr.04.04	bit 3	bit 2	bit 1	bit 0	Multi-function Input Terminal	Terminals Occupied by the Start-up/ Stop Function
Single-wire operation control	0	0	0/1	0/1	0/1	-	MI4, MI3 and MI2 can be set as N.O. or N.C.	MI1 is only controlled by external terminals
Two-wire operation control	1	0 or 1	0/1	0/1	-	-	MI4 and MI3 can be set as N.O. or N.C.	MI1 and MI2 are only controlled by external terminals
Three-wire operation control	1	2	0/1	-	-	-	MI4 can be set as N.O. or N.C.	MI1, MI2 and MI3 are only controlled by external terminals

Setting method:

When setting this parameter, convert bit3–bit0 that represent the status of MI4–MI1 from binary to decimal.

For example: setting MI3 and MI4 to be 1 = N.C.; setting MI1 and MI2 to be 0 = N.O.

Pr.04.09 should be set to 12.

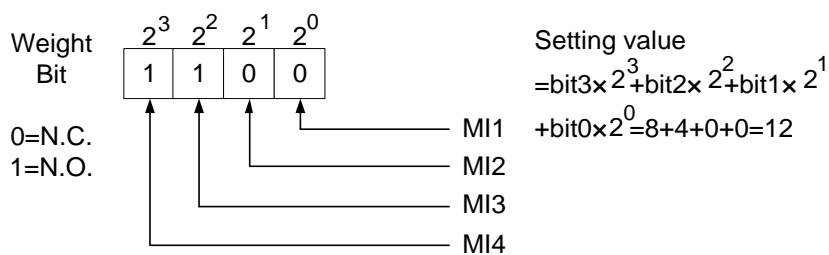

04.10 Digital Terminal Input Response Time

Default: 1

Settings 1–20 (*2ms)

This function is to delay and confirm the digital input terminal signal (unit: 2 ms). The time for delay is also the time for confirmation. The confirmation prevents interference that could cause error in the input to the digital terminals. In the meanwhile, it delays the response time though confirmation improves accuracy.

04.26 Display the Status of Multi-function Input Terminal

Default: Read only

Settings Read only

📖 Displays 63 in Pr.04.26 when all the MI terminals are not active.

- When MI1 (corresponds to bit0) is triggered, and the weight is 1, Pr.04-26 = 62 (63-1).
- When MI2 (corresponds to bit1) is triggered, and the weight is 2, Pr.04-26 = 61 (63-2).
- When MI3 (corresponds to bit2) is triggered, and the weight is 4, Pr.04-26 = 59 (63-4).
- When MI4 (corresponds to bit3) is triggered, and the weight is 8, Pr.04-26 = 55 (63-8).
- If more than one MI terminals are triggered, use 63 minus the weight that corresponds to the MI terminal.

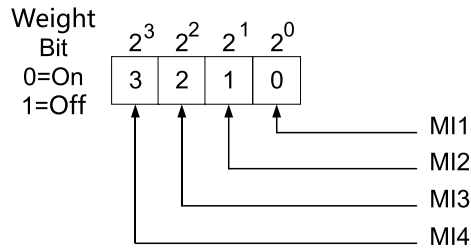

For example, if you set MI2 and MI3 to ON, Pr.04.26 displays 57 ($63-2-4=57$, decimal)

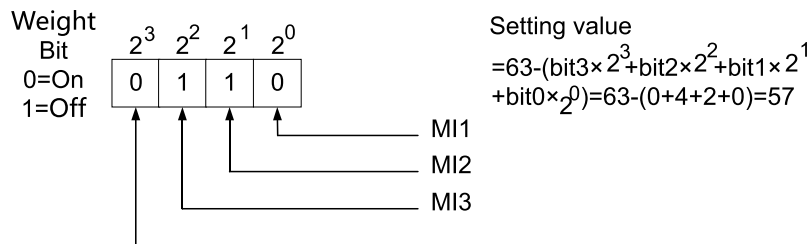

04.27 Internal/ External Multi-Function Input Terminal Selection

Default: 0

Settings 0–63

📖 Selects the terminals MI1–MI4 to be either internal terminal or external terminal. You can activate internal terminals with Pr.04.28. When a terminal is set to internal terminal, the corresponded external terminal is deactivate.

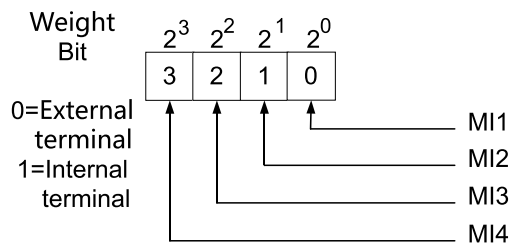

When setting this parameter, convert bit3–bit0 that represent the status of MI4–MI1 from binary to decimal, and then set this parameter. Set MI3 and MI4 as internal terminals; set MI1 and MI2 as external terminals. Pr.04.27 should be set to 12.

Chapter 4 Parameters | VFD-EL-W

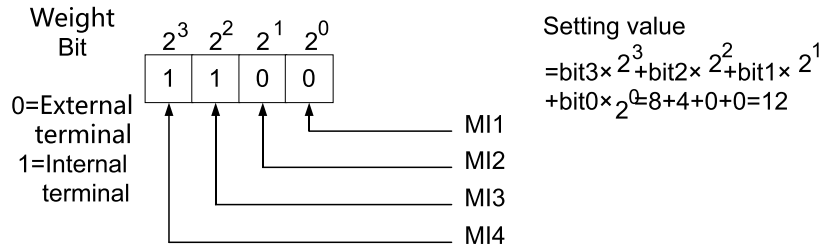

04.28 Status Selection of Multi-function Input Terminal

Default: 0

Settings 0–63

Sets the internal terminal action (ON/ OFF) through the keypad or communication. And use this parameter with Pr.04.27.

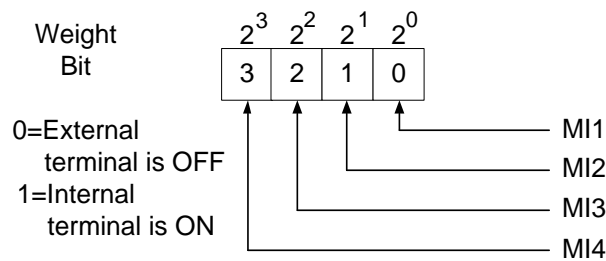

Setting method: set Pr.04.28 to 12 to activate MI3 and MI4.

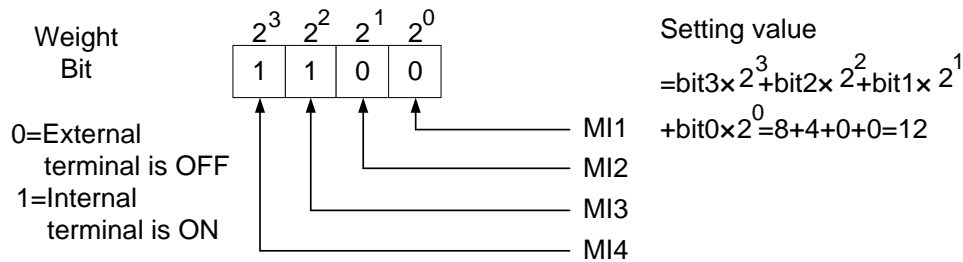

04.20	
-	Reserved
04.25	

05 Multi-step Speed Operation

✎ You can set this parameter during operation.

✎	05.00	1 st Step Speed Frequency
✎	05.01	2 nd Step Speed Frequency
✎	05.02	3 rd Step Speed Frequency
✎	05.03	4 th Step Speed Frequency
✎	05.04	5 th Step Speed Frequency
✎	05.05	6 th Step Speed Frequency
✎	05.06	7 th Step Speed Frequency

Default: 0.00

Settings 0.00–400.00 Hz

📖 Use the multi-function input terminals (refer to Pr.04.06–04-08) to select the multi-step speed command (the maximum is 7th step speed). Pr.05.00 to Pr.05.06 sets the multi-step frequency as shown in the following table.

	Pr.	Multi-Step Speed Command 1	Multi-Step Speed Command 2	Multi-Step Speed Command 3
Master Frequency	Master Speed	OFF	OFF	OFF
1st Step Speed	05.00	ON	OFF	OFF
2nd Step Speed	05.01	OFF	ON	OFF
3rd Step Speed	05.02	ON	ON	OFF
4th Step Speed	05.03	OFF	OFF	ON
5th Step Speed	05.04	ON	OFF	ON
6th Step Speed	05.05	OFF	ON	ON
7th Step Speed Frequency	05.06	ON	ON	ON

06 Protection Parameters

✦ You can set this parameter during operation.

06.00 Over-voltage Stall Prevention

Default: 390.0 / 780.0

Settings 230V models: 330.0–410.0 V (0: Disable)
460V models: 660.0–820.0 V (0: Disable)

- 📖 The default for 230V models is 390.0; the default for 460V models is 780.0.
- 📖 Set Pr.06-01 to 0.0 disables the over-voltage stall prevention function (connected with braking unit or brake resistor).
- 📖 During deceleration, the DC bus voltage may exceed its Maximum Allowable Value due to motor regeneration. When this function is enabled and the DC bus voltage detected is too high, the drive stops decelerating (output frequency remains unchanged) until the DC bus voltage drops below the setting value.
- 📖 This parameter is suitable for uncertain load inertia. When stopping under normal load, the over-voltage does not occur during deceleration and meet the deceleration time setting. Sometimes it may not stop due to over-voltage during decelerating to STOP when the load regenerative inertia increases. In this case, the AC motor drive extends the deceleration time automatically until the drive stops. If the deceleration time affects your application, it is not recommended to use this function. You can also install a brake resistor to absorb the excessive regenerative voltage.

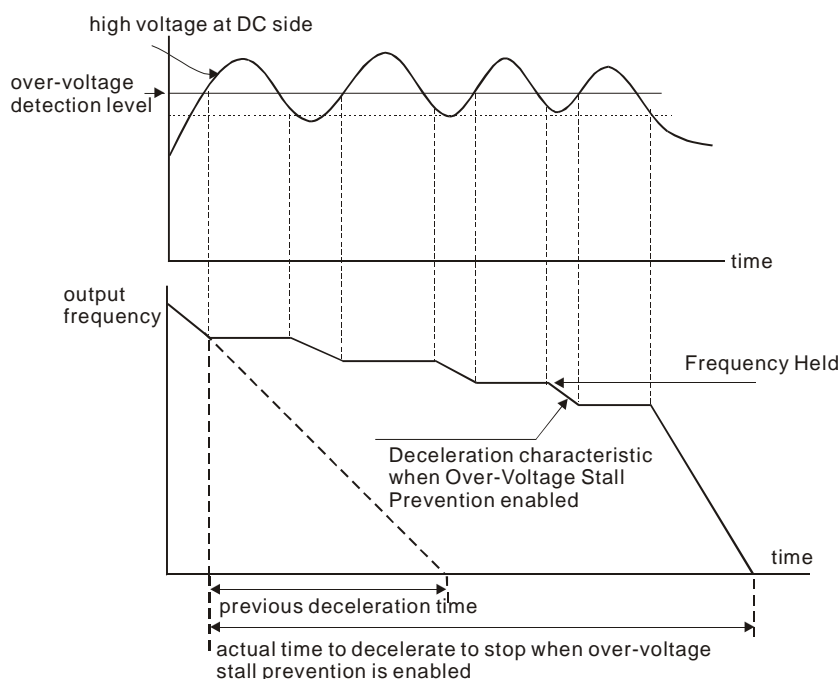

06.01 Over-current Stall Prevention during Acceleration

Default: 170

Settings 20–250% (0: Disable)

- 📖 During acceleration, the AC motor drive output current may increase abruptly and exceed the value specified in Pr.06.01 due to rapid acceleration or excessive load on the motor. When this function is enabled, the AC motor drive stops accelerating and keeps the output frequency constant until the current drops below this setting.

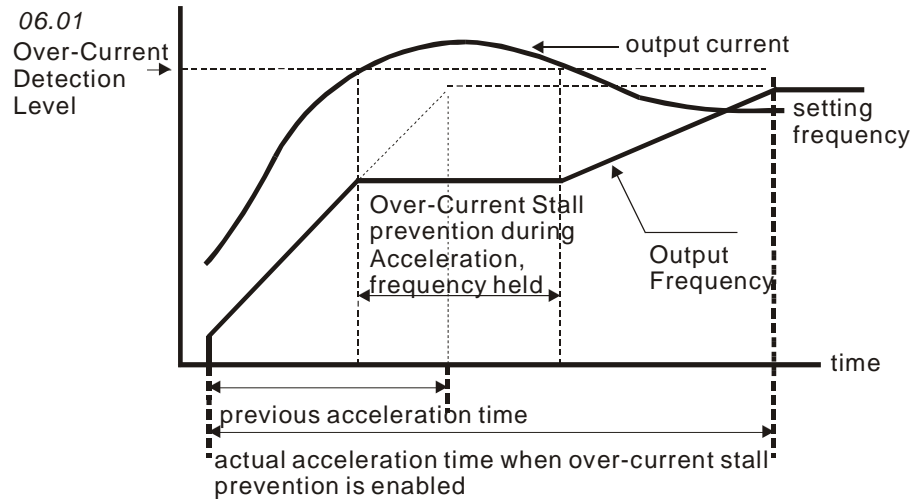

06.02 Over-current Stall Prevention during Operation

Default: 170

Settings 20–250% (0: Disable)

If the output current exceeds the setting value for Pr.06-02 when the drive is operating, the drive decreases its output frequency to prevent motor stall. If the output current is lower than the setting value for Pr.06.02, the drive accelerates again to the setting frequency.

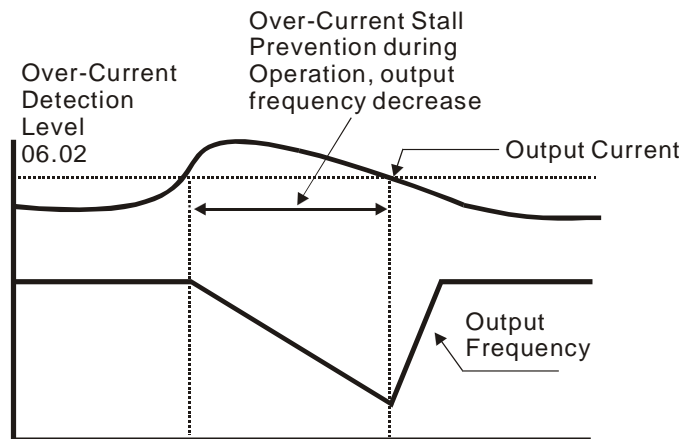

over-current stall prevention during operation

06.03 Over-torque Detection Selection (oL2)

Default: 0

Settings 0: Disabled

- 1: After over-torque detection during constant speed operation, continues operation until oL1 or oL protection activate
- 2: After over-torque detection during constant speed operation, stops and shows oL2 fault
- 3: After over-torque detection during acceleration and constant speed operation, continues operation until oL1 protection activates
- 4: After over-torque detection during constant speed operation, stops and shows oL2 fault

Determines the operation mode of the drive after detecting over-torque (OL2). Detecting method: when the output current exceeds the setting for Pr.06.04, and the detection time is longer than

the setting for Pr.06.05, the warning message “OL2” displays. If a multi-functional output terminal is set to over-torque (OL2) detection (Pr.03.00), the output is ON. (Refer to Pr.03.00)

06.04 Over-Torque Detection Level

Default: 150

Settings 10–200%

- Refer to Pr.06.51 to select whether the over torque level is based on the motor rated current or the drive rated current.
- When Pr.06.51 is set to 0: The over-torque level is based on the motor rated current (Pr.07.00), set Pr.06.04 as the motor allowable overload coefficient.
- When Pr.06.51 is set to 1: The over-torque level is based on the drive rated current (Pr.00.01), it needs to be converted and calculated according to the motor rated current and overload capacity. The calculation is as the following:

$$\text{Motor rated current} \times \text{Motor allowable overload factor} \div \text{Inverter rated current} \times 100\%$$

06.51 OL2 Over-Torque Detection Level Selection

Default: 0

Settings 1: Based on motor's rated current (Pr.07.00)
 2: Based on driver's rated current (Pr.00.01)

06.05 Over-torque Detection Time

Default: 0.1

Settings 0.1–60.0 sec.

- Sets the drive action modes after over-torque detection.
- Over-torque detection method: when output current exceeds the over-torque detection level (Pr.06.04) and the detection time is longer than the setting for Pr.06.05, if the MO terminal is set to over-torque detection, the contact is “closed”. Refer to Pr.03.00 for details.
- Set the overload time corresponding to the allowable overload coefficient of the motor, which cannot exceed the allowable overload time of the motor.

06.06 Electronic Thermal Relay Selection (oL1)

Default: 2

Settings 0: Standard motor (fan cooling)
 1: Special motor (forced external cooling)
 2: Disabled

- Sets the operation of the electronic thermal overload relay that protects the motor from overloading or overheating.

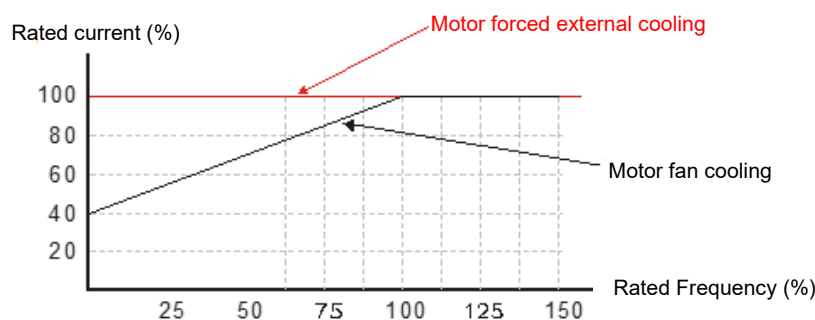

06.07 Electronic Thermal Relay Action Time

Default: 60

Settings 30–600 sec.

 Determines the time required to activate the I²t electronic thermal protection function. The figure below shows I²t curves for 150% output power for one minute.

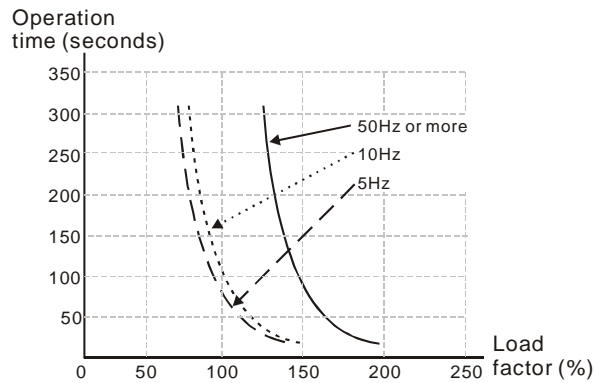
**06.08** Fault Record 1**06.09** Fault Record 2**06.10** Fault Record 3**06.11** Fault Record 4**06.12** Fault Record 5**06.21** Fault Record 6**06.22** Fault Record 7**06.23** Fault Record 8**06.24** Fault Record 9**06.25** Fault Record 10

Default: 0

Settings 0–40

 Fault record description

ID	Descriptions
0	0: No fault record
1	Over-current (oc)
2	Over-voltage (ov)
3	IGBT over-heat (oH1)
4	Reserved
5	Over load (oL)
6	Electronics thermal relay 1 protection (oL1)
7	Motor overload (oL2)
8	External Fault (EF)
9	Over-current during acceleration (ocA)
10	Over-current during deceleration (ocd)
11	Over-current during steady operation (ocn)
12	Reserved

Chapter 4 Parameters | VFD-EL-W

ID	Descriptions
13	Reserved
14	Phase loss (PHL)
15	Reserved
16	Auto-acceleration/ auto-deceleration fail (cFA)
17	Software or password protection (codE)
18	Write error (CF1.0)
19	Read error (CF2.0)
20	Protection circuit error (HPF1)
21	Protection circuit error (HPF2)
22	Reserved
23	Protection circuit error (HPF4)
24	U-phase hardware error (cF3.0)
25	V-phase hardware error (cF3.1)
26	W-phase hardware error (cF3.2)
27	DC bus hardware error (cF3.3)
28	OH1 hardware error (cF3.4)
29	Reserved
30–31	Reserved
32	Analog feedback signal error (AErr)
33	Reserved
34	Motor PTC Overheating Protection (PTC1)
35	PID feedback fault (FbE)
36	PID feedback error (dEv)
37	OPHL
38-40	Reserved

06.13 Detection Time for Motor Phase Loss

Default: 0.0

Settings 0.0: Disable OPHL detection
0.1–60.0 sec.

06.14 Detection Current Level for Motor Phase Loss

Default: 30

Settings 10–100%

 Use Pr.06.13 with Pr.06.14. When three-phase imbalance occurs among three-phase motors and the imbalance reaches Pr.06.14 setting percentage (the percentage is 100% equal to the AC motor drive's rated current settings in Pr.00.01), and lasts for the time set in Pr.06.13, OPHL warning displays and the drive stops to prevent the motor from damage due to the three-phase unbalanced operation.

06.26 Output Frequency Fault 1 (Hz)

06.27 Output Current Fault 1

06.28	Output Voltage Fault 1
06.29	DC bus Voltage Fault 1
06.30	Drive Internal Temperature Fault 1
06.31	Output Frequency Fault 2 (Hz)
06.32	Output Current Fault 2
06.33	Output Voltage Fault 2
06.34	DC bus Voltage Fault 2
06.35	Drive Internal Temperature Fault 2
06.36	Output Frequency Fault 3 (Hz)
06.37	Output Current Fault 3
06.38	Output Voltage Fault 3
06.39	DC bus Voltage Fault 3
06.40	Drive Internal Temperature Fault 3
06.41	Output Frequency Fault 4 (Hz)
06.42	Output Current Fault 4
06.43	Output Voltage Fault 4
06.44	DC bus Voltage Fault 4
06.45	Drive Internal Temperature Fault 4
06.46	Output Frequency Fault 5 (Hz)
06.47	Output Current Fault 5
06.48	Output Voltage Fault 5
06.49	DC bus Voltage Fault 5
06.50	Drive Internal Temperature Fault 5

Default: 0

Settings 0-65535

 Records the drive status corresponded from Fault 1 to Fault 5

07 Motor Parameters

✎ You can set this parameter during operation.

✎ 07.00 Motor Rated Current

Default: 100%FLA

Settings 30.0–120.0% FLA

📖 Sets this value according to the specification as indicated on the motor nameplate. Set the default value according to the drive rated current, therefore, the default is 100% of the drive rated current (FLA).

📖 There will be a 0.1 error between the actual set value and the minimum value of the motor.

📖 If the power of the drive and the motor do not match, the motor needs to be overloaded. Set Pr.06.03, 06.04, and 06.05 motor over-torque protection related parameters.

✎ 07.01 No-Load Current for Motor

Default: 40%FLA

Settings 0.0–99.0% FLA

📖 The setting for the motor no-load current affects the slip compensation.

✎ 07.02 Auto-Torque Compensation

Default: 0.0

Settings 0.0–10.0

📖 Sets the AC motor drive to automatically increase voltages to get a higher torque when the AC motor drive is running.

✎ 07.03 Torque Compensation Gain

Default: 0.00

Settings 0.00–10.00

📖 For an asynchronous motor, increasing the load on the AC motor drive causes slip to increase and results in decreased speed. Use this parameter to set the compensation frequency, and reduce the slip to maintain the synchronous speed when the motor runs at the rated current in order to improve the accuracy of the drive. When the output current of the AC motor drive is larger than the motor no-load current value (Pr.07.01), the AC motor drive adjusts the output frequency according to this parameter. If the actual speed ratio is slower than expected, increase the parameter setting value; otherwise, decrease the setting value.

✎ 07.04 Motor Parameter Auto-Tuning

Default: 0

Settings 0: Disabled

1: Auto-tuning R1 (motor does not run)

2: Auto-tuning R1 + no-load current (motor runs)

📖 Set this parameter to 1 and 2 for motor auto-tuning, the drive starts auto-tuning when receiving RUN command. 1: Auto-detect only the R1 value, and manually enter Pr.07.01; 2: Unload the AC motor drive and automatically set the values for Pr.07.01 and Pr.07.05.

Motor auto-tuning process:

1. Ensure that all the parameters are set to defaults and the motor wiring is correct.
2. Ensure that the motor is not loaded before executing auto-tuning and that the shaft is not connected to any belt or reducer.
3. Enter the correct settings for Pr.01.01 Motor Rated Frequency (Fbase), Pr.01.02 Motor Rated Voltage (Vbase), Pr.07.00 Motor Rated Current, and Pr.07.06 Motor Rated Slip (Motor 0).
4. After you set Pr.07.04 to 2, the AC motor drive executes auto-tuning immediately after receiving a RUN command. **(NOTE: be careful for personnel and mechanical damage from the motor operation.)** The total auto-tuning time is 15 seconds = Pr.01.09 + Pr.01.10. (Higher-power drives need longer acceleration and deceleration time.)
5. After executing auto-tuning, check to ensure there are values filled in for Pr.07.01 and Pr.07.05. If not, press the RUN key after setting Pr.07.04 again to repeat auto-tuning.
6. If the result of above auto-tuning is correct, set Pr.00.10 to 1 and set other parameters according to your application requirements.

Related parameters:

- Pr.01.01 Motor Rated Frequency
- Pr.01.02 Motor Rated Voltage
- Pr.07.00 Motor Rated Current
- Pr.07.01 Motor No-load Current
- Pr.07.05 Motor Resistance R1
- Pr.07.06 Motor Rated Slip

NOTE: In vector control mode, it is not recommended to have motors run in parallel, or operate the motor with a rated power that exceeds the rated power of the AC motor drive.

07.05 Motor Resistance R1 (Line to Line)

Default: 0

Settings 0–65535 mΩ

 This parameter is automatically set after the motor auto-tunes. You can also set this parameter according to the known motor correct parameter. This resistance value is the R value between phase and phase of the motor. Regardless of the motor wiring method, this resistance value is the measured value of any two motor leads.

07.06 Motor Rated Slip

Default: 3.00

Settings 0.00–20.00 Hz

 Sets the motor rated slip. Enter the actual rated RPM from the motor nameplate.

 Refer to the rated RPM and the number of poles from the motor nameplate and use the following equation to calculate the rated slip:



$$\text{Rated Slip} = F - N \times P / 120$$

F: Rated frequency (Hz)

N: Rated speed (rpm)

P: number of poles (Pole)

Chapter 4 Parameters | VFD-EL-W

-  Assume that the motor rated frequency is 60 Hz with 4 poles, and the rated motor speed is 1650 rpm. The rated slip calculated by the formula is $60 \text{ Hz} - (1650 \text{ rpm} \times 4 / 120) = 5 \text{ Hz}$.
-  This parameter is related to Pr.07.03 Slip Compensation Gain. To get the best slip compensation effect, you must enter the correct settings. The incorrect setting may cause invalid slip compensation and even damage to the motor and to the AC motor drive.

Related Parameters: Pr.07.03 Torque Compensation Gain

07.07 Slip Compensation Limit

Default: 200

Settings 0–250%

-  Sets the upper limit of the compensation frequency for the correction amount of the slip compensation function, that is, the multiplier of Pr.07.06 motor rated slip. If the motor speed is lower than the target speed and the speed does not change after adjusting the Pr.07.03 setting, the AC motor drive may reach the upper limit of the compensation frequency. Increase the Pr.07.07 setting and check again.

Related parameters:

- Pr.07.03 Torque Compensation Gain
- Pr.07.06 Motor Rated Slip

07.08 Torque Compensation Low Pass Filter Time

Default: 0.10



Settings 0.01–10.00 sec.

-  This function is usually applied in applications with heavy load where the motor current changes frequently for the current compensation to increase the output torque. The frequent current change causes machine vibration. Increase the Pr.07.08 setting to solve this problem.

07.09 Slip Compensation Low Pass Filter Time

Default: 0.20

Settings 0.05–10.00 sec.

-  This function is usually applied in applications with heavy load where the motor current changes frequently for the current compensation to reach the synchronous speed. The frequent current change causes machine vibration. Increase the Pr.07.09 setting to solve this problem.
-  If you set Pr.07.08 and Pr.07.09 to 10 seconds, the compensation response time is the slowest; however, the system may be unstable if you set the time too short.

07.10 Accumulated Motor Operation Time (minutes)

Default: 0

Settings 0–1439

07.11 Accumulated Motor Operation Time (days)

Default: 0

Settings 0–65535

-  Record the motor operation time. To clear the operation time, set Pr.07.10 and Pr.07.11 to 0. Any operation time shorter than 60 seconds is not recorded.

07.12 Motor PTC Overheating Protection

Default: 0

Settings 0: Disabled
1: Enable

07.14 Motor PTC Overheating Protection Level

Default: 2.4

Settings 0.1–10.0 V

- 📖 Running the motor at low frequency for a long time reduces the cooling function of the motor fan. To prevent overheating, use a Positive Temperature Coefficient thermistor on the motor, and connect the thermistor output signal to the drive's corresponding control terminals.
- 📖 When you set the source of the first and second frequency command to AVI (Pr.02.00 = 1 / Pr.02.09 = 1), you disable the motor PTC overheat protection (that is, Pr.07.12 cannot be set to 1).
- 📖 If the temperature exceeds the setting level, the motor coasts to stop and PtC1 (P t C 1) displays. When the temperature decreases below the level of (Pr.07.15 minus Pr.07.16) and stops blinking, you can press the RESET key to clear the fault.
- 📖 Pr.07.14 (overheat protection level) must be greater than Pr.07.15 (overheat warning level).
- 📖 The PTC function uses the AVI, +10V and ACM terminals, when PTC enables (Pr.07.12 = 1), it uses AVI as PTC input and is connected with a resistor-divider as shown in the diagram below.
 1. The voltage between +10V to ACM: lies within 10.4–11.2V.
 2. The internal impedance for AVI is around 47 kΩ Recommended value for divider resistance is 1K–10K Ω.
 3. Contact your motor dealer for the curve of temperature and resistance value for PTC.

Protection level: $Pr.07.14 = V+10 \times (R_{PTC1} // 47k) \div [R1 + (R_{PTC1} // 47k)]$
 Warning level: $Pr.07.15 = V+10 \times (R_{PTC2} // 47k) \div [R1 + (R_{PTC2} // 47k)]$
 V+10: voltage between +10V-ACM actual value;
 R_{PTC1} : motor PTC overheat protection level; R_{PTC2} : motor PTC overheat warning level
 47 kΩ: the AVI input impedance; R1: divider resistance (recommended value: 1–10k Ω)

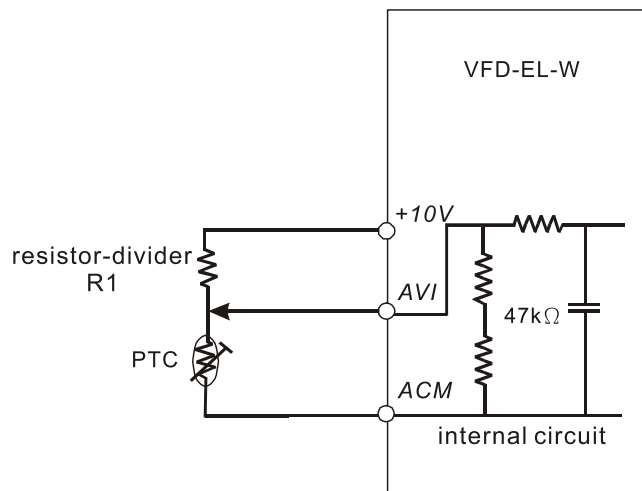

Take the standard PTC thermistor as an example: if the protection level is 1330 Ω, the actual voltage between +10V-ACM is 10.5 V and divider resistance R1 is 4.4k Ω.

Chapter 4 Parameters | VFD-EL-W

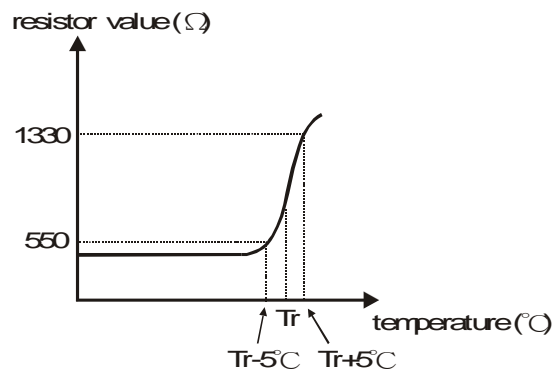

Refer to the following calculation when Pr.07.14 is set to 2.4 and motor temperature overheating protection level is 1330 Ω:

$$1330 // 47000 = (1330 \times 47000) \div (1330 + 47000) = 1293.4$$

$$10.5 \times 1293.4 \div (4400 + 1293.4) = 2.38 \text{ (V)} \approx 2.4 \text{ (V)}$$

07.15 Motor PTC Overheating Warning Level

Default: 1.2

Settings 0.1–10.0 V

07.16 Motor PTC Overheating Warning Reset Level

Default: 0.6

Settings 0.1–5.0 V

07.17 Motor PTC Overheating Action

Default: 0

Settings 0: Warn and ramp to stop
1: Warn and coast to stop
2: Warn and continue operation

If the temperature reaches the motor PTC Overheat Warning Level (Pr.07.15), the drive acts according to Pr.07.17 and displays PtC2 (P t C 2) on the digital keypad. If the temperature decreases below the result of (Pr.07.15 minus Pr.07.16), the warning message disappears.

07.13 Motor PTC Overheating Protection Input Filter Time

Default: 100

Settings 0–9999 (unit: 2ms)

08 Special Parameters

✦ You can set this parameter during operation.

08.00 DC Brake Current Level

Default: 0

Settings 0–100%

- 📖 Sets the level of the DC brake current output to the motor at start-up and stop. When setting the DC brake current, the rated current is 100%. Therefore, when you set this parameter, increase the level slowly to reach the desired holding torque. The set value cannot exceed the motor rated current.

08.01 DC Brake Time at Start-up

Default: 0.0

Settings 0.0–60.0 sec.

- 📖 This parameter determines the duration of the DC brake current output to the motor when the drive starts up.

08.02 DC Brake Time at STOP

Default: 0.0

Settings 0.0–60.0 sec.

- 📖 This parameter determines the duration of the DC Brake current output to the motor when braking. To enable the DC brake at STOP, you must set Pr.02.02 (Stop Method) to 0 or 2 (ramp to stop).

08.03 DC Brake Frequency at STOP

Default: 0.00

Settings 0.00–400.00 Hz

- 📖 Determines the start frequency of the DC brake before the drive ramps to stop. When this setting is less than Pr.01.05 (Start-up Frequency), the start frequency for the DC brake begins at the minimum frequency.

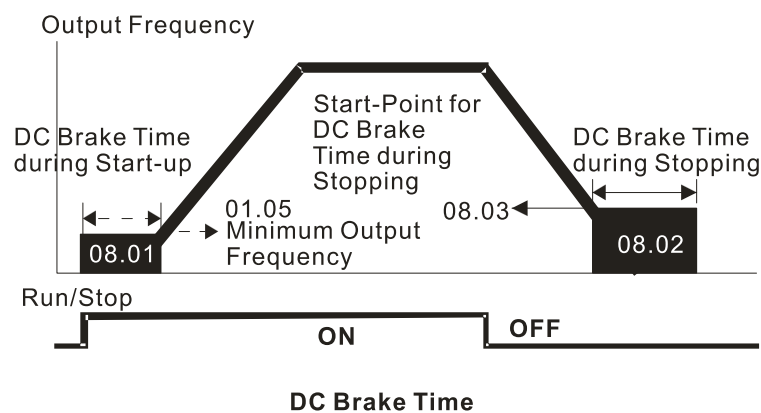

- 📖 Use the DC brake before running the motor when the load is movable at stop, such as with fans and pumps. The motor is in free running status and in unknown rotation direction before the drive starts up. Execute the DC brake before you start the motor.
- 📖 Use the DC Brake at STOP when you need to brake the motor quickly or to control the positioning. Such as cranes or cutting machines.

08.04 Momentary Power Loss Action

Default: 0

Settings 0: Stop operation

1: Operation continues after momentary power loss, speed search starts with the last frequency

2: Operation continues after momentary power loss, speed search starts with the minimum frequency

 Determines the operation mode when the drive restarts from a momentary power loss.

08.05 Maximum Allowable Power Loss Time

Default: 2.0

Settings 0.1–20.0 sec.

 Determines the maximum time of allowable power loss. If the duration of a power loss exceeds this parameter setting, the AC motor drive stops output after the power recovers.

 The selected operation after power loss in Pr.08.04 is only executed when the maximum allowable power loss time is ≤ 5 seconds and the AC motor drive keypad displays “Lv”. If the AC motor drive is powered off due to overload, even if the maximum allowable power loss time is ≤ 5 seconds, the drive does not execute the operation mode you set for Pr.08.04. In that case it starts up normally.

08.06 Base Block Speed Search

Default: 1

Settings 0: not using

1: Speed search starts with the last speed before B.B.

2: Speed search starts with the minimum speed (Pr.01.05)

 Determines the AC motor drive restart method after an External Base Block is enabled.

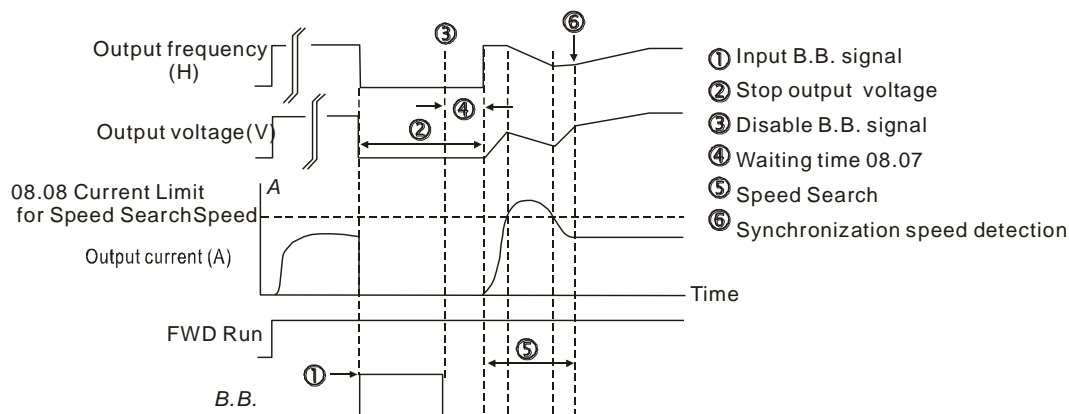

Fig 1: B.B. Speed Search with Last Output Frequency Downward Timing Chart (Speed Search Current Attains Speed Search Level)

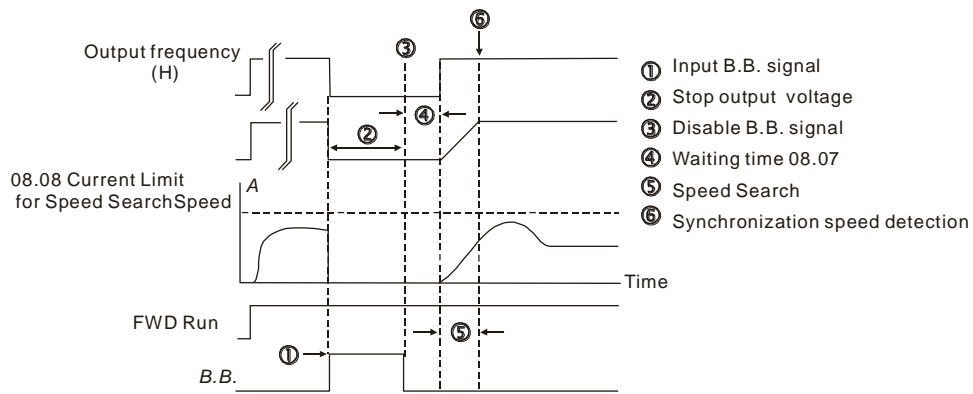

Fig 2: B.B. Speed Search with Last Output Frequency Downward Timing Chart (Speed Search Current doesn't Attain Speed Search Level)

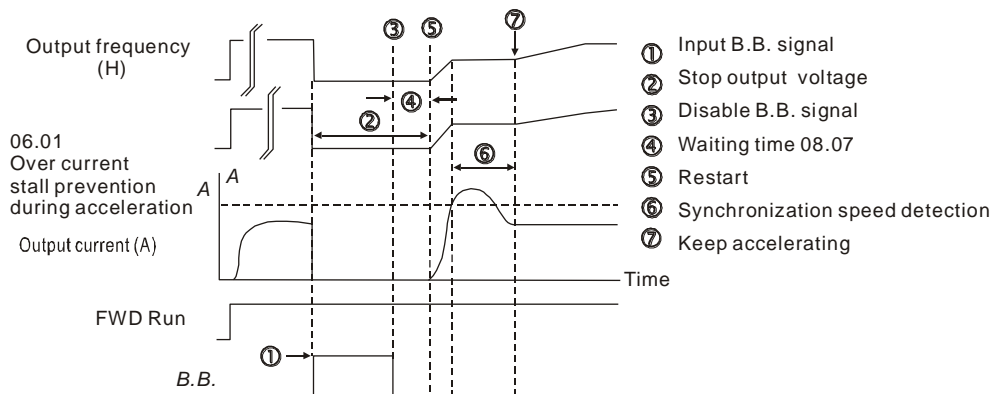

Fig3: B.B. Speed Search with Minimum Output Frequency Upward Timing Chart

08.07 Speed Tracking Delay Time

Default: 0.5

Settings 0.1–5.0 sec.

- 📖 When momentary power loss is detected, the AC motor drive blocks its output and then waits for a specified period of time before resuming operation. Set this parameter to the time that allows the residual voltage at the output side to decrease to 0V before activating the drive again.
- 📖 When the external interrupt (B.B.) resets and restarts after fault, you can also use this parameter for speed tracking.

08.08 Speed Tracking Action Level

Default: 150

Settings 30–200%

- 📖 Limits the drive output current during the speed tracking.
- 📖 When executing the speed tracking, the V/F curve is defined by the settings in Parameter Group 01.

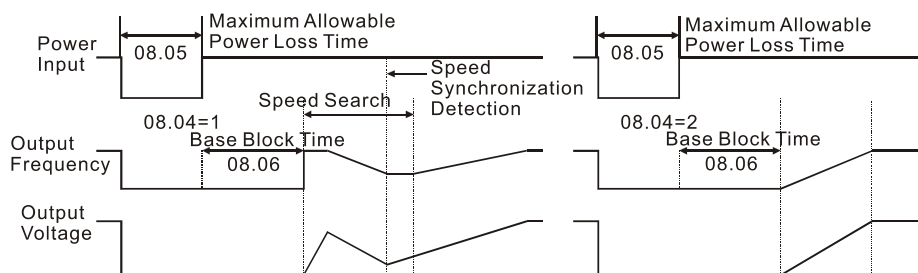

Momentary Power Loss Operation

Chapter 4 Parameters | VFD-EL-W

✓	08.09	Skip Frequency 1 Upper Limit
✓	08.10	Skip Frequency 1 Lower Limit
✓	08.11	Skip Frequency 2 Upper Limit
✓	08.12	Skip Frequency 2 Lower Limit
✓	08.13	Skip Frequency 3 Upper Limit
✓	08.14	Skip Frequency 3 Lower Limit

Default: 0.00

Settings 0.00–400.00 Hz

- 📖 Sets the AC motor drive's skip frequency. The drive's frequency setting skips these frequency ranges. However, the frequency output is continuous. Set these six parameters as follows
 $Pr.08.09 \geq Pr.08.10 \geq Pr.08.11 \geq Pr.08.12 \geq Pr.08.13 \geq Pr.08.14$.

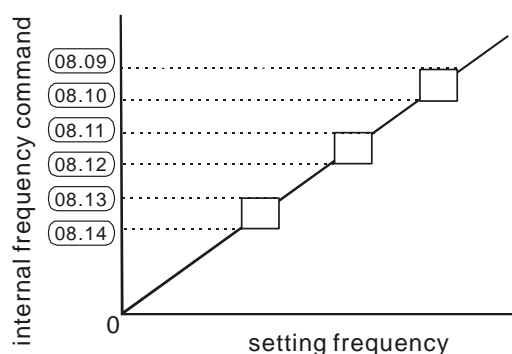
**08.15** Number of Times of Restart after Fault

Default: 0

Settings 0–10

- 📖 After fault (allowed fault: oc, ov) occurs, the AC motor drive can reset and restart automatically up to 10 times.
- 📖 If Pr.08.15 is set to 0, the drive does not reset or restart automatically after faults occur. When the drive restarts after fault, it starts by speed tracking from top to bottom.
- 📖 If the number of faults exceeds the Pr.08.15 setting, the drive does not reset and restart until you press "RESET" manually and execute the operation command again.

08.16 Auto-restart Interval of Fault

Default: 60.0

Settings 0.1–6000.0 sec.

- 📖 Use this parameter in conjunction with Pr.08.15. When a reset/ restart occurs after a fault, the drive uses Pr.08.16 as a timer and starts counting the number of faults within this time period. Within this period, if the number of faults does not exceed the setting for Pr.08.15, the counting clears and starts from 0 when the next fault occurs.
- 📖 If you set Pr.08.15 to 10 and Pr.08.16 to 600 seconds (10 minutes), when there is no fault for over 600 seconds from the restart for the previous fault, the AC motor drive can automatically reset/ restart up to ten times.

08.17 Auto-Energy Saving Operation

Default: 0

Settings 0: Disable
1: Enable

- When energy-saving is enabled, the motor acceleration/ deceleration operates with full voltage. During constant speed operation, it automatically calculates the best voltage value according to the load power. This function is not suitable for fluctuating loads or loads that are nearly full during operation.

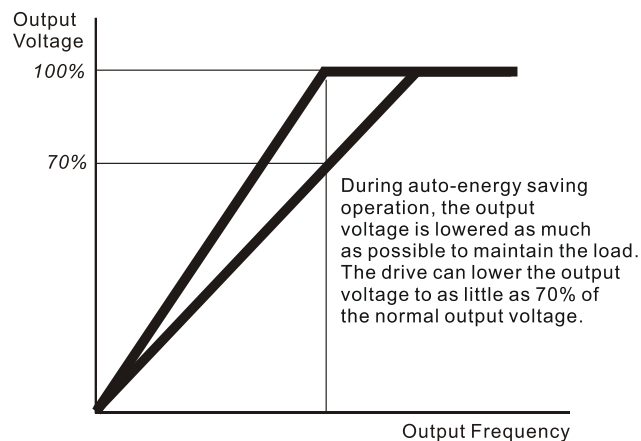

08.18 Automatic Voltage Regulation (AVR) Function

Default: 0

Settings 0: Enable AVR
1: Disable AVR
2: Disable AVR during deceleration
3: Disable AVR at STOP

- The rated voltage of a 220V motor is usually 200 V_{AC}, 60 Hz / 50 Hz, and the input voltage of the AC motor drive may vary from 180–264 V_{AC}, 50 Hz / 60 Hz. Therefore, when the AC motor drive is used without the AVR function, the output voltage is the same as the input voltage. When the motor runs at the voltage exceeding 12–20% of the rated voltage, it causes higher temperatures, damaged insulation, and unstable torque output, which result in losses due to shorter motor lifetime.
- The AVR function automatically regulates the output voltage of the AC motor drive to the motor's rated voltage when the input voltage exceeds the motor's rated voltage. For example, if the V/F curve is set at 200 V_{AC}/ 50 Hz and the input voltage is at 200–264 V_{AC}, then the drive automatically reduces the output voltage to the motor to a maximum of 200 V_{AC}/ 50 Hz. If the input voltage is at 180–200 V_{AC}, the output voltage to motor is in direct proportion to the input voltage.
- When the motor ramps to stop, disable the AVR function to shorten the deceleration time. Then, use with the auto-acceleration and auto-deceleration functions to make the motor's deceleration more stable and quicker.

08.19 Reserved**08.20** Oscillation Suppression

Default: 0.0

Settings 0.0–5.0

-
-  The drift current occurs in a specific zone of the motor and it causes serious motor vibration. Adjust this parameter could greatly improve this situation. (The drift current zone for high-power motors is usually in the low frequency area.) The recommended setting value is 2.0.

09 Communication Parameters

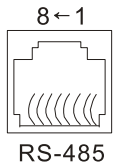

Serial interface

1: NC 5: SG+
 2: Vcc 6-7: NC
 3: GND 8: Vcc
 4: SG-

Note:
 NC: Not Connect
 VCC: Power
 GND: Grounded

✦ You can set this parameter during operation.

✦ 09.00 Communication Address

Default: 1

Settings 1–254

📖 Sets the communication address for the drive if the AC motor drive is controlled through RS-485 serial communication. The communication address for each AC motor drive must be unique.

✦ 09.01 Communication Transmission Speed

Default: 1

Settings 0: Baud rate 4800 bps
 1: Baud rate 9600 bps
 2: Baud rate 19200 bps
 3: Baud rate 38400 bps

📖 Sets the transmission speed of RS-485 serial communication.

✦ 09.02 Communication Fault Treatment

Default: 3

Settings 0: Warn and continue operation
 1: Warn and ramp to stop
 2: Warn and coast to stop
 3: No Warn and continue operation

📖 Determines the drive action when a transmission fault occurs.

✦ 09.03 Communication Time-Out Detection

Default: 0.0

Settings 0.0–120.0 sec.

📖 Sets the detection time for communication time-out. When there is no data transmission during the setting time of Pr.09.03, it means the communication time-out. If you set Pr.09.02 to 0–2, then the digital keypad shows “cE10”.

✦ 09.04 Communication Protocol

Default: 0

Settings 0: 7, N, 2 for ASCII
 1: 7, E, 1 for ASCII
 2: 7, O, 1 for ASCII
 3: 8, N, 2 for RTU
 4: 8, E, 1 for RTU
 5: 8, O, 1 for RTU

Chapter 4 Parameters | VFD-EL-W

- 6: 8, N, 1 for RTU
- 7: 8, E, 2 for RTU
- 8: 8, O, 2 for RTU
- 9: 7, N, 1 for ASCII
- 10: 7, E, 2 for ASCII
- 11: 7, O, 2 for ASCII

- 📖 Computer Link: When using the RS-485 serial communication interface, you must specify each drive's communication address in Pr.09.00. The computer then implements control using the drives' individual addresses.
- 📖 The VFD-EL-W series drive uses Modbus networks communication protocol. The Modbus uses one of the following two modes: ASCII (American Standard Code for Information Interchange) or RTU (Remote Terminal Unit). The ASCII mode transfers the data into corresponded ASCII code before transmission; meanwhile, the RTU directly transmits the data without translation. The followings are descriptions for ASCII mode:
 - 📖 The CPU delays about 1 second when using the communication reset; therefore, there is at least 1 second delay time in the master station.
 - 📖 Each 8-bit data is the combination of two ASCII characters. For example, one byte of data: 64 Hex, shown as '64' in ASCII, consists of '6' (36Hex) and '4' (34Hex). The following table is the ASCII characters:

Character	'0'	'1'	'2'	'3'	'4'	'5'	'6'	'7'
ASCII code	30H	31H	32H	33H	34H	35H	36H	37H
Character	'8'	'9'	'A'	'B'	'C'	'D'	'E'	'F'
ASCII code	38H	39H	41H	42H	43H	44H	45H	46H

Data Format

For ASCII

(7, N, 2)

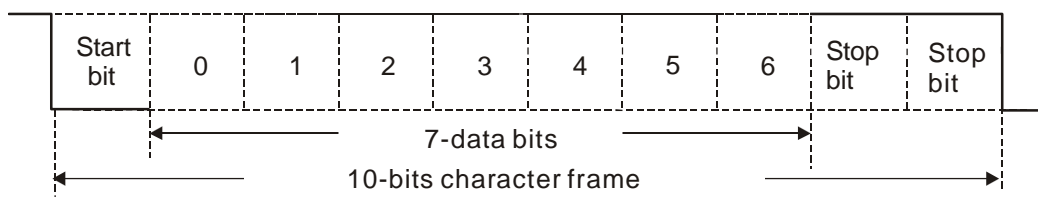

(7, E, 1)

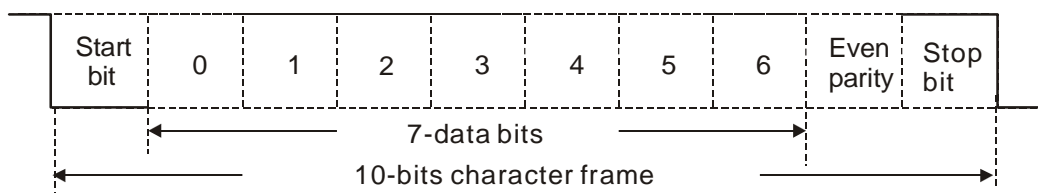

(7, O, 1)

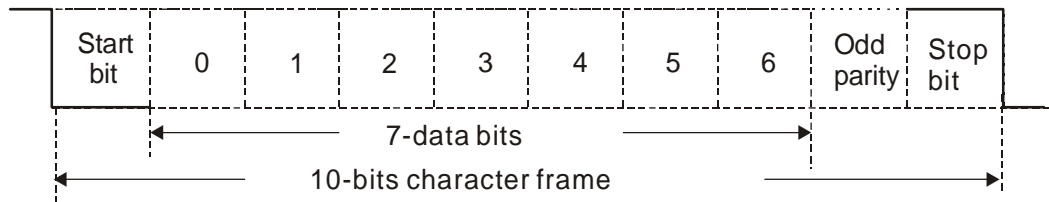

(7, N, 1)

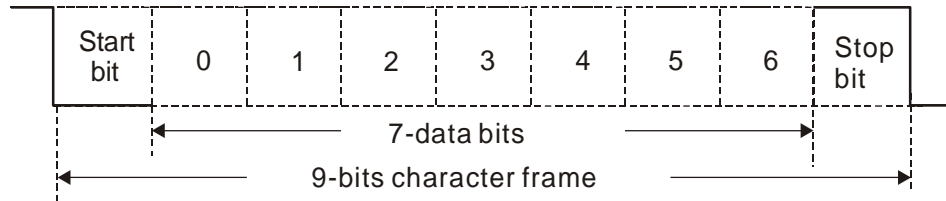

(7, E, 2)

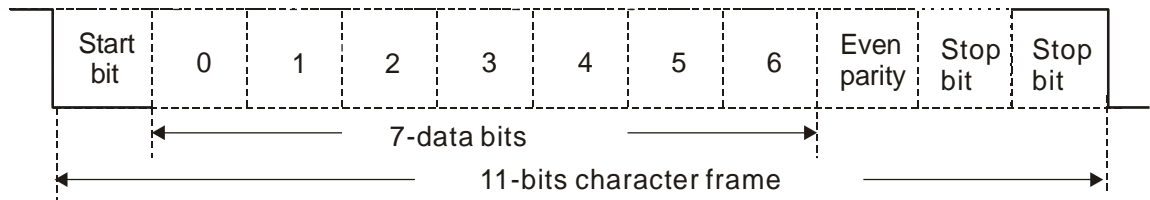

(7, O, 2)

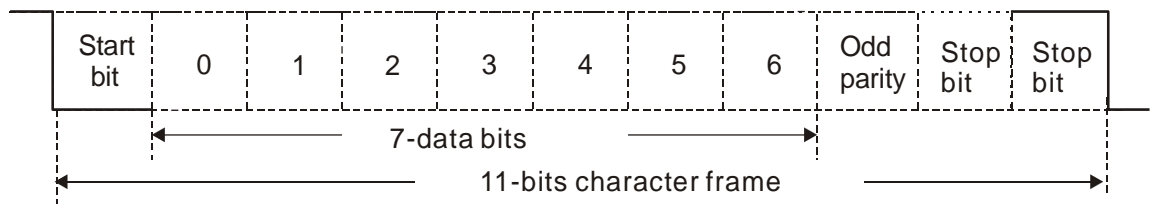

For RTU

(8, N, 2)

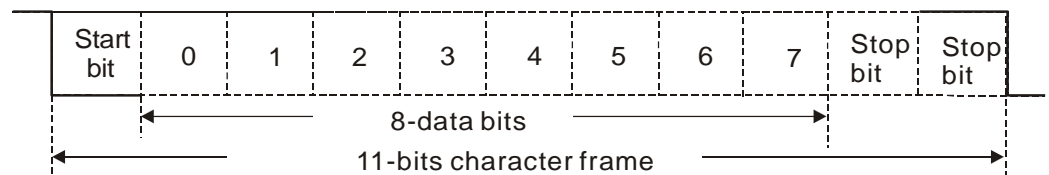

(8, E, 1)

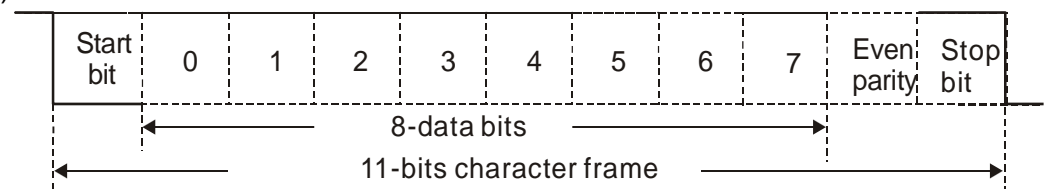

(8, O, 1)

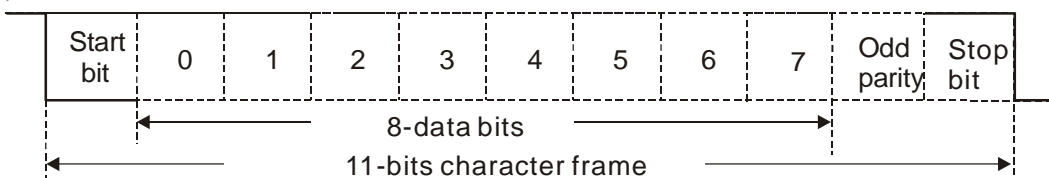

Chapter 4 Parameters | VFD-EL-W

(8, N, 1)

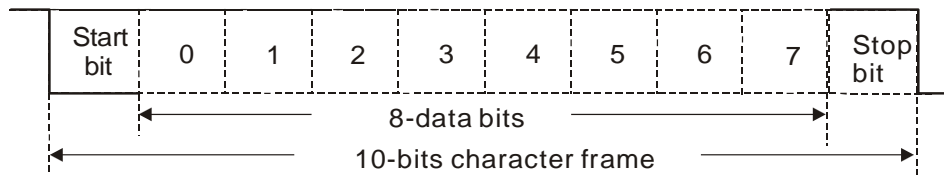

(8, E, 2)

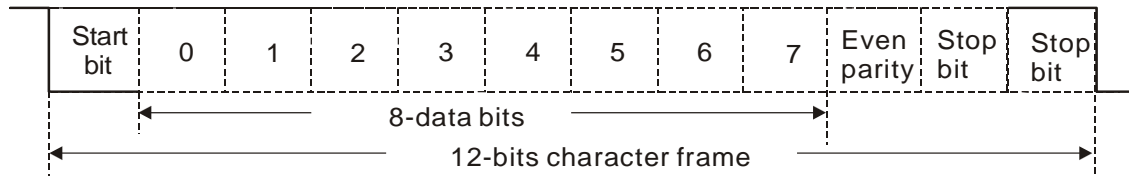

(8, O, 2)

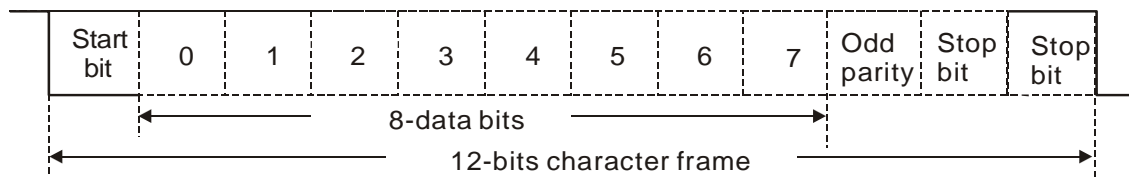

Communication Protocol

3.1 Communication Data Frame

ASCII mode:

STX	Start character = ':' (3AH)
Address High	Communication address: one 8-bit address consists of 2 ASCII codes
Address Low	
Function High	Command code: one 8-bit command consists of 2 ASCII codes
Function Low	
DATA (n-1)	Contents of data: n x 8-bit data consists of 2n ASCII codes
.....	
DATA 0	
LRC Check High	LRC checksum: one 8-bit checksum consists of 2 ASCII codes
LRC Check Low	
END High	End characters: END High = CR (0DH), END Low = LF (0AH)
END Low	

RTU mode:

START	A silent interval of more than 10 ms
Address	Communication address: 8-bit binary address
Function	Command code: 8-bit binary command
DATA (n-1)	Contents of data: n x 8-bit data, n ≤ 40 (20 x 16-bit data).
.....	
DATA 0	
LRC Check Low	CRC checksum: one 16-bit CRC checksum consists of 2 8-bit binary characters
LRC Check High	
END	A silent interval of more than 10 ms

3.2 Communication Address (Address)

00H: Broadcast to all AC motor drives

01H: AC motor drive at address 01

0FH: AC motor drive at address 15

10H: AC motor drive at address 16, and so on up to 254 (FEH).

3.3 Function (Function code) and DATA (Data characters)

03H: Read data from register

06H: Write single register

08H: Loop detection

Function code 03H: read data from registers (multi-read up to 20 data)

Example: Reading two continuous data from register address 2102H. AMD address is 01H.

ASCII mode:

Command Message		Response Message	
STX	':'	STX	':'
Address	'0'	Address	'0'
	'1'		'1'
Function	'0'	Function	'0'
	'3'		'3'
Starting address	'2'	Number of data (count by byte)	'0'
	'1'		'4'
	'0'	Content of starting address 2102H	'1'
	'2'		'7'
Number of data (count by word)	'0'	Content of address 2103H	'7'
	'0'		'7'
	'0'	LRC Check	'0'
	'2'		'0'
LRC Check	'D'	LRC Check	'0'
	'7'		'7'
END	CR	END	'1'
	LF		CR
			LF

RTU mode:

Command Message		Response Message	
Address	01H	Address	01H
Function	03H	Function	03H
Starting data address	21H	Number of data (count by byte)	04H

Chapter 4 Parameters | VFD-EL-W**Command Message**

	02H
Number of data (count by word)	00H
	02H
LRC Check Low	6FH
LRC Check High	F7H

Response Message

Content of data address 2102H	17H
	70H
Content of data address 2103H	00H
	00H
LRC Check Low	FEH
LRC Check High	5CH

Function code 06H: write single register (can write up to 20 data to the register at the same time)

Example: Writing data 6000 (1770H) to register 0100H. AMD address is 01H.

ASCII mode:

Command Message

STX	‘:’
Address	‘0’
	‘1’
Function	‘0’
	‘6’
Data address	‘0’
	‘1’
	‘0’
	‘0’
Data content	‘1’
	‘7’
	‘7’
	‘0’
LRC Check	‘7’
	‘1’
END	CR
	LF

Response Message

STX	‘:’
Address	‘0’
	‘1’
Function	‘0’
	‘6’
Data address	‘0’
	‘1’
	‘0’
	‘0’
Data content	‘1’
	‘7’
	‘7’
	‘0’
LRC Check	‘7’
	‘1’
END	CR
	LF

RTU mode:

Command Message

ADR	01H
CMD	08H
Data	00H
	00H
Data	17H
	70H
LRC Check Low	8EH
LRC Check High	0EH

Response Message

ADR	01H
CMD	08H
Data	00H
	00H
Data	17H
	70H
LRC Check Low	8EH
LRC Check High	0EH

(1) ASCII mode (LRC Check):

LRC (Longitudinal Redundancy Check) is calculated by summing up the values of the bytes from ADR1 to the last data character then calculating the hexadecimal representation of the 2's-complement negation of the sum. Take the above 3.3.1 Command Message for example: 01H + 03H + 21H + 02H + 00H + 02H = 29H, take complementary number of 2 = D7H

LRC (Longitudinal Redundancy Check) is calculated from Address to Data content. It is calculated by the following steps:

Step 1: Load a 16-bit register (called CRC register) with FFFFH.

Step 2: Exclusive OR the first 8-bit byte of the command message with the low order byte of the 16-bit CRC register, and put the result in the CRC register.

Step 3: Examine the LSB of CRC register.

Step 4: If the LSB of CRC register is 0, shift the CRC register one bit to the right, fill MSB with zero, then repeat step 3. If the LSB of CRC register is 1, shift the CRC register one bit to the right, fill MSB with zero, Exclusive OR the CRC register with the polynomial value A001H, then repeat step 3.

Step 5: Repeat step 3 and 4 until you perform eight shifts. This processes a complete 8-bit byte.

Step 6: Repeat step 2 through 5 for the next 8-bit byte of the command message. Continue doing this until all bytes are processed. The final contents of the CRC register are the CRC value. When transmitting the CRC value in the message, the upper and lower bytes of the CRC value must be swapped, that is, the lower order byte is transmitted first.

The following is an example of CRC generation using C language. The function takes two arguments:

Unsigned char* data ← a pointer to the message buffer

Unsigned char length ← the quantity of bytes in the message buffer

The function returns the CRC value as a type of unsigned integer. Unsigned int

crc_chk(unsigned char* data, unsigned char length)

```
{
int j;
unsigned int reg_crc=0xffff;
while(length--){
    reg_crc ^= *data++;
    for(j=0;j<8;j++){
        if(reg_crc & 0x01){ /* LSB(b0)=1 */
            reg_crc=(reg_crc>>1) ^ 0xa001;
        }else{
            reg_crc=reg_crc >>1;
        }
    }
}
```

Chapter 4 Parameters | VFD-EL-W

```

    }
  }
}
return reg_crc; // return register CRC

```

Address list

Content	Parameter address	Function		
AC motor drive parameters	GGnnH	GG is the parameter group, nn is the parameter number. For example, the address of Pr.04-10 is 0401H.		
Command write only	2000H	bit0-1	00B: No function	
			01B: Stop	
			10B: Run	
			11B: JOG + RUN	
		bit2-3	Reserved	
		bit4-5	00B: No function	
			01B: FWD	
			10B: Direction reverse	
			11B: Change direction	
		bit6-7	00B: 1st step accel./decel.	
			01B: 2nd step accel./decel.	
			Reserved	
		2001H	Frequency command	
		2002H	bit0	1: EF ON
			bit1	1: Reset command
	bit2		1: Base Block (B.B) ON	
	bit3-4 bit6-15		Reserved	
Enable Fire Mode		bit5	00B: No function	
			01B: Start Fire Mode (without RUN command)	
Status monitor read only	2100H	Error code		
		0: No fault record		
		1: Over-current (oc)		
		2: Over-voltage (ov)		
		3: IGBT overheat (OH1)		
		4: Reserved		
		5: Drive Over load (oL)		
		6: Motor over load (oL1)		
		7: Over-torque (oL2)		
		8: External fault (EF)		
		9: Over-current during acceleration (ocA)		
		10: Over-current during deceleration (ocd)		
		11: Over-current at constant speed (ocn)		
		12: Reserved		
		13: Low voltage (Lv)		
14: Input phase loss (PHL)				

Content	Parameter address	Function
		15: Reserved
		16: Auto-acceleration / auto-deceleration failure (cFA)
		17: Software and parameter password protection (codE)
		18: CPU write error (cF1.0)
		19: CPU read error (cF2.0)
		20: CC, OC hardware protection error (HPF1)
		21: OV hardware protection error (HPF2)
		22: Reserved
		23: OC hardware protection error (HPF4)
		24: U-phase hardware error (cF3.0)
		25: V-phase hardware error (cF3.1)
		26: W-phase hardware error (cF3.2)
		27: DC bus hardware error (cF3.3)
		28: OH1 hardware error (cF3.4)
		29: Reserved
		30: Reserved
		31: Reserved
		32: Reserved
		33: Reserved
		34: Reserved
		35: Reserved
		36: Reserved
		37: OPHL
	2101H	bit 0–1 LED status of digital keypad 00B: RUN LED is OFF, STOP LED is ON (the drive stops) 01B: RUN LED flashes, STOP LED is ON (when drive decelerates to stop) 10B: RUN LED is ON, STOP LED flashes (the drive is standby) 11B: RUN LED is ON, STOP LED is off (the drive runs)
		bit 2 1: JOG command
		bit 3–4 00B: FWD light is ON, REV light is OFF (the drive runs in a forward direction) 01B: FWD light is ON, REV light flashes (when the drive changes the running direction from REV to FWD) 10B: FWD light flashes, REV light is ON (when the drive changes the running direction from FWD to REV) 11B: FWD light is OFF, REV light is ON (the drive runs in a reverse direction)
		bit 5–7 Reserved
		bit 8 1: Master frequency controlled by the communication interface
		bit 9 1: Master Frequency command controlled by analog signal input

Chapter 4 Parameters | VFD-EL-W

Content	Parameter address	Function	
		bit 10	1: Operation command controlled by the communication interface
		bit 11–15:	Reserved
	2102H	Frequency command (F)	
	2103H	Output frequency (H)	
	2104H	Output current (XX.XA)	
	2105H	Reserved	
	2106H	Reserved	
	2107H	Reserved	
	2108H	DC bus voltage (XXX.X V)	
	2109H	Output voltage (XXX.X V)	
	210AH	IGBT temperature (°C)	
	2116H	User-defined (Low word)	
	2117H	User-defined (High word)	

NOTE:

2116H is the number display for Pr.00.04. The high byte of 2117H is the number of decimal places for 2116H. The low byte of 2117H is the ASCII code of the alphabetic display for Pr.00.04.

Exception response:

When the drive is using the communication connection, if an error occurs, the drive responds to the error code and sets the highest bit (bit 7) of the command code to 1 (function code AND 80H) then responds to the control system to signal that an error occurred. If the keypad displays “CEXX” as a warning message, “XX” is the error code at that time. Refer to the table of error codes for communication error for reference.

The following table shows some examples:

ASCII mode:		RTU mode:	
STX	‘:’	Address	01H
Address	‘0’	Function	86H
	‘1’	Exception code	02H
Function	‘8’	LRC Check Low	C3H
	‘6’	LRC Check High	A1H
Exception code	‘0’		
	‘2’		
LRC Check	‘7’		
	‘7’		
END	CR		
	LF		

Table of fault codes:

Fault code	Descriptions
01	Illegal function code: the drive cannot recognize the function code (03H, 06H, 08H, 10H).
02	Illegal data address: the drive cannot recognize the data address.
03	Illegal data value: the data value received in the command message is not available for the drive.
04	Slave device failure: the drive is unable to perform the requested action.
10	Transmission time-out

Communication program of PC:

The following is a simple example of how to write a communication program for Modbus ASCII mode on a PC by C language.

```
#include<stdio.h>
#include<dos.h>
#include<conio.h>
#include<process.h>
#define PORT 0x03F8 /* the address of COM1 */
/* the address offset value relative to COM1 */
#define THR 0x0000
#define RDR 0x0000
#define BRDL 0x0000
#define IER 0x0001
#define BRDH 0x0001
#define LCR 0x0003
#define MCR 0x0004
#define LSR 0x0005
#define MSR 0x0006
unsigned char rdat[60];
/* read 2 data from address 2102H of AC drive with address 1 */
unsigned char tdat[60]={'.' , '0' , '1' , '0' , '3' , '2' , '1' , '0' , '2' , '0' , '0' , '0' , '2' , 'D' , '7' , '\r' , '\n'};
void main(){
    int i;
    outportb(PORT+MCR · 0x08); /* interrupt enable */
    outportb(PORT+IER · 0x01); /* interrupt as data in */
    outportb(PORT+LCR · (inportb(PORT+LCR) | 0x80));
    /* the BRDL/BRDH can be access as LCR.b7==1 */
    outportb(PORT+BRDL · 12); /* set baudrate=9600 · 12=115200/9600*/
    outportb(PORT+BRDH · 0x00);
    outportb(PORT+LCR · 0x06); /* set protocol · <7 · N · 2>=06H ·
```

Chapter 4 Parameters | VFD-EL-W

```

<7 · E · 1>=1AH
<7 · O · 1>=0AH ·
<8 · N · 2>=07H ·
<8 · E · 1>=1BH
<8 · O · 1>=0BH ·
*/

for(i=0;i<=16;i++){
    while(!(inportb(PORT+LSR) & 0x20)); /* wait until THR empty */
    outportb(PORT+THR · tdat[i]);      /* send data to THR */  }
i=0;
while(!kbhit()){
    if(inportb(PORT+LSR) & 0x01){ /* b0==1 · read data ready */
        rdat[i++]=inportb(PORT+RDR); /* read data form RDR */
    } } }

```

09.05 Reserved**09.06** Reserved**09.07** Communication Response Delay Time

Default: 1

Settings 0–200 (unit: 2ms)

 If the host controller does not finish the transmitting/receiving process, you can use this parameter to set the response delay time after the AC motor drive receives communication command as shown in the following picture.

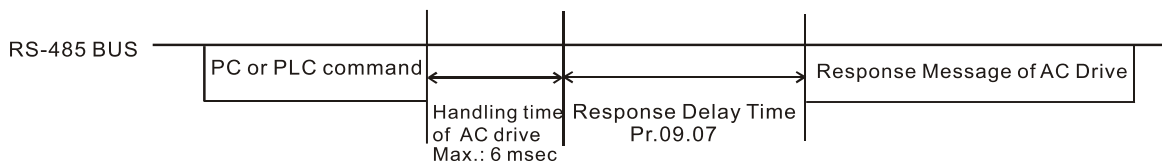
**09.08** Communication Keypad Selection

Default: 0

Settings 0: PU06

1: PU08

 After changing the communication method, you need to power off and reboot the drive, or unplug the keypad and plug it in again to establish new communication.

10 PID Control Parameters

✈ You can set this parameter during operation.

10.00 PID Set Point Selection

Default: 0

- Settings
- 0: PID function disabled
 - 1: Digital keypad
 - 2: Reserved
 - 3: Reserved
 - 4: PID reference target value (Pr.10.11)

- 📖 Set Pr.00.03 = 3 and 00.04 = 8 for feedback value to display the PID set point on the control panel at the same time.
- 📖 When Pr.10.00 is set to 1 and operated by the keypad, adjust the set point by pressing the up/down keys directly on any display interface if you need to set the set point.
- 📖 When Pr.10.00 is set to 4, the setting range of Pr.10.11 is limited by the maximum operating frequency of Pr.01.00. The maximum frequency value of 01.00 is the maximum value of the physical quantity to the set point corresponds to the maximum range of the physical quantity measured by the sensor (set in Pr.10.18).
- 📖 If the set and displayed target value directly correspond to physical quantities such as pressure, temperature, flow, etc., you also need to set Pr.00.13 and Pr.00.14 at the same time. For example, when the maximum range of the set point set as 16.0 bar, you also need to set Pr.00.13 = 160, 00.14 = 1.
- 📖 The target physical quantity corresponding to the frequency set by Pr.10.11 = $(Pr.10.11 / Pr.01.00) \times Pr.00.13 \times 10^{-(Pr.00.14)}$. For example, Pr.10.11 = 20 Hz, Pr.01.00 = 50 Hz, Pr.00.13 = 160, Pr.00.14 = 1, then the target physical quantity = $20 / 50 \times 160 \times 0.1 = 8.0$.
- 📖 The following table shows the set point physical quantity and the operating frequency of the drive, sensor feedback value correspond to the physical quantity, set point setting method and relationship.

Corresponded Relation	Set Point Physical Quantity	Corresponded Drive Operation Frequency	Sensor Feed Value Corresponding to the Physical Quantity	PID Set Point	
Parameter Setting	Pr.00.13 = 160 Pr.00.14 = 1	Pr.00.02 = 9 Pr.01.00 = 50	Pr.10.18 = 16.0	Pr.10.00 = 1 Keypad up/down keys	Pr.10.00 = 4 Pr.10.11 = 50
Lower Limit	0	0	0	0	0
Upper Limit	16.0	50	16.0	16.0	16.0

10.01 Input Terminal for PID Feedback

Default: 0

- Settings
- 0: Positive PID feedback from external terminal AVI (0–10 V_{DC})
 - 1: Negative PID feedback from external terminal AVI (0–10 V_{DC})
 - 2: Positive PID feedback from external terminal ACI (4–20 mA)
 - 3: Negative PID feedback from external terminal ACI (4–20 mA)

- 📖 Select the input terminal as the PID detection terminal, and note that the master frequency

Chapter 4 Parameters | VFD-EL-W

source cannot be the same.

- 📖 Negative feedback: $\text{Error} = \text{Target value (set point)} - \text{Feedback}$. Use negative feedback when the detection value increases if the output frequency increases.
- 📖 Positive feedback: $\text{Error} = - \text{Target value (set point)} + \text{Feedback}$. Use positive feedback when the detection value decreases if the output frequency increases.

↗ **10.11** PID Target Value

Default: 0.00

Settings 0.00–400.00 Hz

- 📖 Sets the target value when Pr.10.00 (PID Set Point Selection) is set to 4.

↗ **10.02** Proportional Gain (P)

Default: 1.0

Settings 0.0–10.0

- 📖 Gain P responds to the degree of deviation, and the deviation is reduced proportionally by setting this parameter.
- 📖 Increasing Gain P can speed up the system response and reduce the steady-state error. But if you set the value too high, it may cause overshoot and system oscillation, and reduce the system stability. Decrease the setting value may slow down the system response, but it can increase the system stability.
- 📖 If you set the other two gains (I and D) to zero, proportional control is the only effective parameter.

↗ **10.03** Integral Time (I)

Default: 1.00

Settings 0.00–100.0 sec.

- 📖 Use the integral controller to eliminate the deviation during stable system operation. The integral control does not stop working until the deviation is zero. The integral is affected by the integral time. The smaller the integral time, the stronger the integral action. It is helpful to reduce overshoot and oscillation for a stable system. Accordingly, the speed to lower the steady-state deviation decreases. The integral control is often used with the other two controls for the PI controller or PID controller.
- 📖 Sets the integral time of the I controller. When the integral time is long, there is a small I controller gain, with slower response and slow external control. When the integral time is short, there is a large I controller gain, with faster response and rapid external control.
- 📖 When the integral time is too short, it may cause overshoot or oscillation for the output frequency and system.
- 📖 Set Integral Time to 0.00 to disable the I controller.

↗ **10.04** Differential Time (D)

Default: 0.00

Settings 0.00–1.00 sec.

- 📖 Use the differential controller to show the system deviation change, as well as to preview the change in the deviation. You can use the differential controller to eliminate the deviation in order

to improve the system state. Using a suitable differential time can reduce overshoot and shorten adjustment time; however, the differential operation increases noise interference. Note that a too large differential causes more noise interference. In addition, the differential shows the change and the differential output is 0 when there is no change. Note that you cannot use the differential control independently. You must use it with the other two controllers for the PD controller or PID controller.

- 📖 Sets the D controller gain to determine the deviation change response. Using a suitable differential time reduces the P and I controllers overshoot to decrease the oscillation for a stable system. A differential time that is too long may cause system oscillation.
- 📖 The differential controller acts on the change in the deviation and cannot reduce the interference. Do not use this function when there is significant interference.

10.05 Upper Limit of Integral Control

Default: 100

Settings 0–100%

- 📖 Defines an upper bound for the integral gain (I) and therefore limits the master frequency. The formula is: Integral upper bound = Maximum Operation Frequency (Pr.01.00) × (Pr.10.05 %).
- 📖 An excessive integral value causes a slow response due to sudden load changes and may cause motor stall or machine damage. If so, decrease it to a proper value.

10.06 PID Delay Time

Default: 0.0

Settings 0.0–2.5 sec.

- 📖 The PID delay output reduces the system oscillation.

PID Control:

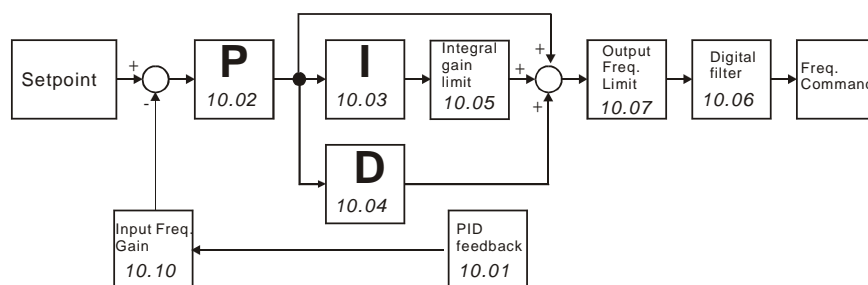

10.07 PID Output Frequency Limit

Default: 100

Settings 0–110%

- 📖 Defines the percentage of the output frequency limit during the PID control. The formula is Output Frequency Limit = Maximum Operation Frequency (Pr.01.00 × Pr.10.07%).

10.08 PID Feedback Signal Error Deviation Detection Time

Default: 60.0

Settings 0.0–3600.0 sec.

- 📖 Defines the detection time when the PID feedback ACI signal is abnormal. You can also use it when the system feedback signal response is extremely slow. (Setting the detection time to 0.0 disables the detection function.)

10.09 PID Feedback Signal Error Treatment

Default: 0

Settings 0: Warn and ramp to stop
 1: Warn and coast to stop
 2: Warn and continue operation

 Sets the treatments when the PID feedback signal (such as ACI analog signal) is abnormal.

10.10 PID Detection Value Gain

Default: 1.0

Settings 0.0–10.0

 Sets the gain adjustment over the feedback detection value, use this parameter to adjust the deviation between the set point and the feedback signal value.

10.12 PID Feedback Signal Error Deviation Level

Default: 10.0

Settings 0.0–100.0%

10.13 PID Feedback Signal Error Deviation Detection Time

Default: 5.0

Settings 0.1–300.0 sec.

 The base for Pr.10.12 is Pr.01.00. When the PID feedback control is enabled, and (PID set point source – feedback) is larger than Pr.10.12, and the time exceeds the Pr.10.13 setting, then the multi-function output terminal #16 (PID Feedback Error) displays as a warning and acts according to Pr.10.20 settings.

 When you set Pr.10.12 to 0, the PID feedback error detection function is disabled.

10.17 PID Offset

Default: 0.00

Settings 0.00–60.00 Hz

 Selects the minimum output frequency in the PID control mode according to your applications.

10.14 Sleep Detection Time

Default: 0.0

Settings 0.0–6550.0 sec.

10.15 Sleep Frequency

Default: 0.00

Settings 0.00–400.00 Hz

10.16 Wake-up Frequency

Default: 0.00

Settings 0.00–400.00 Hz

 Sleep mode setting requirements:

- PID function must be enabled when using Sleep mode.
- The wake-up frequency Pr.10.16 setting must be higher than the sleep frequency Pr.10.15, and ensure that there must be an appropriate difference between them (5 Hz or above) to

prevent frequent switching between the two frequency status.

- The sleep frequency Pr.10.15 setting must be higher than the Pr.01.08 output frequency lower limit to prevent being limited for sleep mode.
- The sleep frequency Pr.10.15 setting must be higher than the Pr.01.05 minimum output frequency.

📖 Sleep/ wake-up mode status description for the AC motor drive:

- When the actual output frequency $H < \text{Pr.10.15}$ and the time exceeds the Pr.10.14 setting, the AC motor drive no longer outputs and is in sleep mode after the AC motor drive decelerates to Pr.01.05 minimum output frequency following the deceleration time limit (Pr.10.15).
- When the AC motor drive is in sleep mode, the frequency command F is still calculated by PID. The state of the wake-up shows as the following diagram.
 1. Before the frequency command F calculated by the PID reaches the wake-up frequency Pr.10.16, the AC motor drive is in sleep mode, and the output frequency H is 0 Hz. The duration of this period of time is affected by the PID parameters (Pr.10.02, Pr.10.03, and Pr.10.04).
 2. When the frequency command F calculated by the PID reaches the wake-up frequency Pr.10.16, the AC motor drive output frequency H accelerates from Pr.01.05 minimum output frequency to Pr.10.16 wake-up frequency following the V/F curve.
 3. When the actual output frequency H of the AC motor drive accelerates to Pr.10.16 wake-up frequency, control the AC motor drive output frequency H by PID.

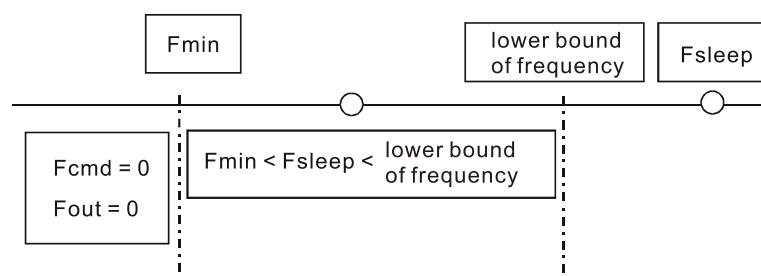
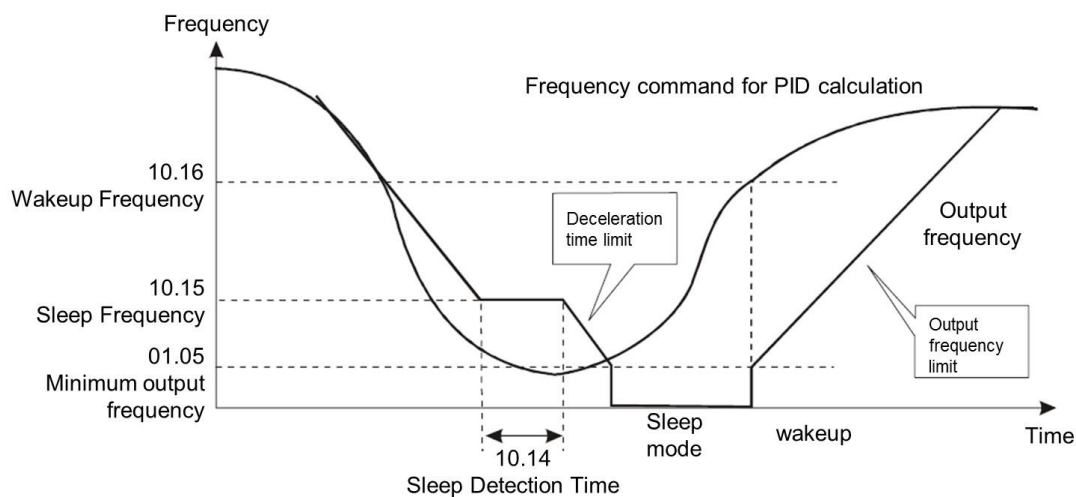

📖 When the PID function is enabled and the sleep mode is disabled:

- If $\text{Pr.01.08} > \text{Pr.01.05}$, the lower limit of the drive output frequency H is limited by Pr.01.08.
- If $\text{Pr.01.08} \leq \text{Pr.01.05}$, the lower limit of the drive output frequency H is limited by Pr.01.05. When it reaches Pr.01.05, the drive stops output and is in ready status.

10.18 PID Feedback Physical Quantity

Default: 99.9

Settings 1.0–99.9

- Pr.10.18 set value is the conversion base of the corresponding relationship between the sensor feedback analog quantity and the feedback physical quantity, and usually set to the maximum value of the sensor input range physical quantity.
- Select Pr.10.01 value according to the sensor output signal type 0–10 V/ 4–20 mA and specific control requirements.
- The sensor output range is 4–20 mA, the feedback physical quantity = (sensor measurement feedback current - 4) ÷ (20 - 4) × Pr.10.18.
 - The sensor output range is 0–10 mA, the feedback physical quantity = (sensor measurement feedback voltage - 0) ÷ (10 - 0) × Pr.10.18.
 - For example, the pressure sensor range is 0–16.0 bar, and the corresponding output range is 4–20 mA. When the Pr.10.18 is set to 16.0 and the sensor's actual measurement output is 12 mA, the actual feedback physical quantity = (12 - 4) ÷ (20 - 4) × 16.0 = 8.0 bar, the corresponding relationship is shown in the table below.
- Set Pr.00.03 = 3 and Pr.00.04 = 8 to display the actual feedback physical quantity on the digital keypad. And the physical quantity correspond to the feedback value displayed on the right side of ":". Refer to Pr.00.04 description for more details.

Corresponded Relation	Sensor Feedback Value		Feedback Value Corresponds to the Physical Quantity
	ACI	AVI	
Parameter Setting	Pr.10.01 = - 2 or 3	Pr.10.01 = - 0 or 1	Pr.10.18 = 16.0
Lower Limit	4 mA	0 V	0 bar
Medium value	12 mA	5 V	8.0 bar
Upper Limit	20 mA	10 V	16.0 bar

10.19 PID Calculation Mode Selection

Default: 0

Settings 0: Serial connection

1: Parallel connection

- Serial connection

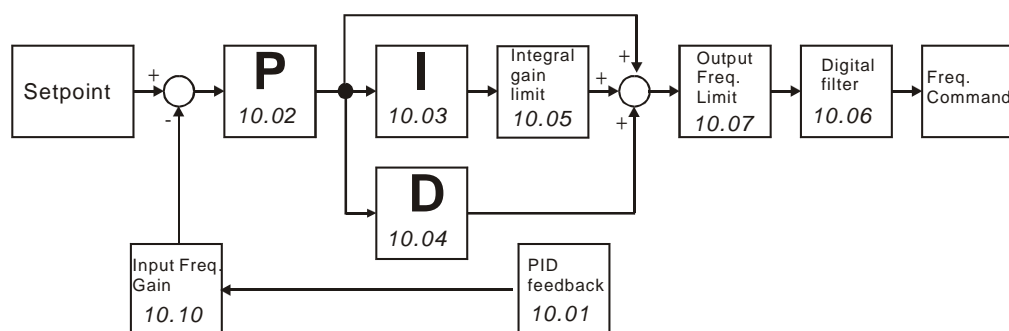

Parallel connection

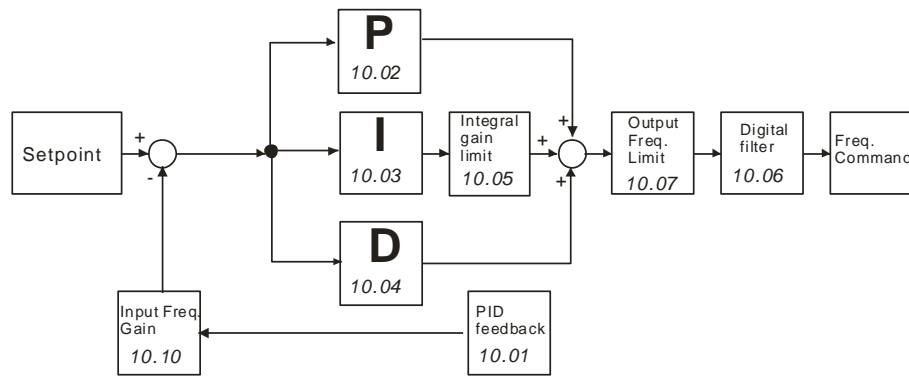

10.20 PID Error Deviation Treatment

Default: 0

- Settings
- 0: Warn and continue operation (no treatment)
 - 1: Warn and coast to stop
 - 2: Warn and ramp to stop
 - 3: Coast to stop and restart after Pr.10.21 delay time (no warning)
 - 4: Ramp to stop and restart after Pr.10.21 delay time. The number of times of restart is limited by Pr.10.50

In PID control mode, the AC motor drive acts according to this parameter when it detects PID feedback deviation level occurs (Pr.10.12 and Pr.10.13).

10.21 PID Error Deviation Restart Delay Time

Default: 60

Settings 0–9999 sec.

10.22 Set Point Deviation Level

Default: 0

Settings 0–100%

10.23 Set Point Stop Detection Time

Default: 10

Settings 0–9999 sec.

Pr.10.22 is based on the PID set point. If the deviation is less than Pr.10.22 and exceeds the time set in Pr.10.23, the drive decelerates to stop to be constant pressure status (this deceleration time is based on the setting for Pr.01.12). If the deviation is still in the range of the error set during deceleration to stop, the system is in standby status.

Example:

If the set point of constant pressure control of a pump is 4 kg, Pr.10.22 is set to 5%, Pr.10.23 is set to 15 seconds, then the deviation is 0.2 kg ($4 \text{ kg} \times 5\% = 0.2 \text{ kg}$). It means when the feedback value is higher than 3.8 kg for a time exceeding 15 seconds, the AC motor drive decelerates to stop, this deceleration time acts according to Pr.01-12. When the feedback value is less than 3.8 kg, the AC motor drive starts to run.

10.24 Deviation Level of Liquid Leakage

Default: 0

Settings 0–50%

- This parameter is based on the PID set point. When the drive does not run and is in a constant pressure status, and if the deviation is higher than Pr.10.24 due to liquid leakage (minor pressure loss), the AC motor drive starts to run.
- Use this parameter to avoid the drive frequent start-up and stop due to liquid leakage (minor pressure loss).

Liquid Leakage Deviation Level Detection

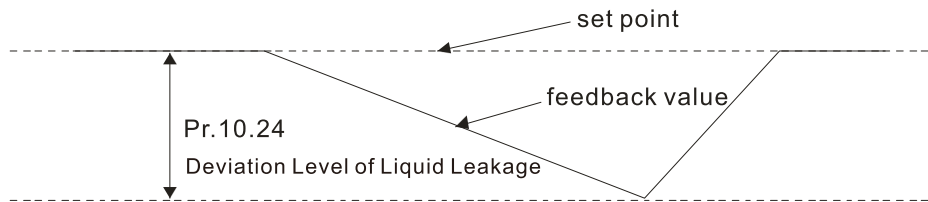

10.25 Liquid Leakage Change Detection

Default: 0

Settings 0: Disable
0–100%

10.26 Liquid Leakage Change Detection Time

Default: 0.5

Settings 0: Disable
0.1–10.0 sec.

- Pr.10.25 and Pr.10.26 define the variation of the feedback value within a time unit in the case of liquid leakage (minor pressure loss).
- Pr.10.25 sets the variation of the feedback value based on the PID set point; Pr.10.26 is the setting value within a time unit. If the variation of the feedback value is less than the settings for Pr.10.25 and Pr.10.26, the liquid leakage occurs. When the drive does not run and is in a constant pressure status, and if the variation of the feedback value is higher than the settings for Pr.10.25 and Pr.10.26, the AC motor drive starts to run in order to keep the system stable.
- Liquid Leakage/ Usage Deviation Level Detection

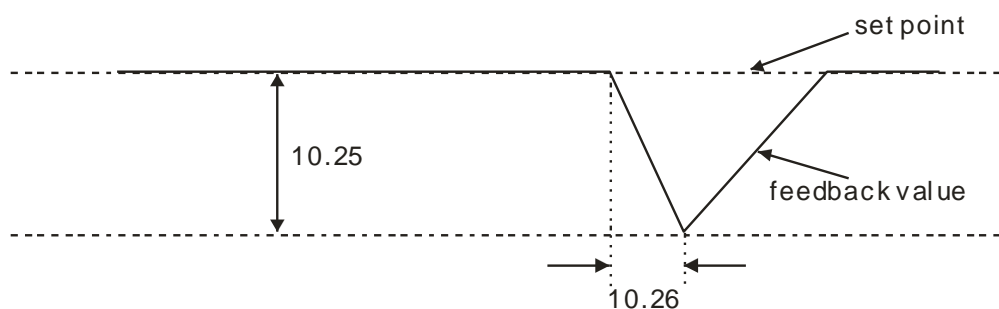

Example:

If the set point of constant pressure control of a pump is 4 kg, Pr.10.22 is set to 5%, Pr.10.23 is set to 15 seconds, Pr.10.24 is set to 25%, Pr.10.25 is set to 3% and Pr.10.26 is set to 0.5

seconds, then the deviation is 0.2 kg ($4 \text{ kg} \times 5\% = 0.2 \text{ kg}$). It means when the feedback value is higher than 3.8 kg for a time exceeding 15 seconds, the AC motor drive decelerates to stop, this deceleration time acts according to Pr.01.12.

Case 1: Assume that when the AC motor drive does not run and is in a constant pressure status, the variation of the feedback value is less than 0.12 kg ($4 \text{ kg} \times 3\% = 0.12 \text{ kg}$) within 0.5 second. When the feedback value continues to decrease to make the deviation of the set point be less than 1 kg ($4 \text{ kg} \times 25\% = 1 \text{ kg}$), that is, when the feedback value is less than 3 kg, the AC motor drive starts to run.

Case 2: When the AC motor drive is in constant pressure status, it does not operate until the feedback change value exceeds 0.12 bar within 0.5 seconds, which means the AC motor drive starts operating when the feedback value is less than 3.88 bar within 0.5 seconds.

10.27 Reserved

10.28 Reserved

10.29 Reserved

10.30 Reserved

10.31 Reserved

10.32 Reserved

10.33 Reserved

10.35 Multi-Pump Operation Mode

Default: 0

Settings 0–2

00: Disable

01: Fixed time circulation (alternative operation)

02: Fixed quantity control (multi-pump operating at constant pressure)

 When using the multi-pump control mode, you must set Pr.10.35 for each pump to the same value.

10.36 Multi-Pump ID

Default: 0

Settings 0–4

0: Disable multi-pump function

1: Master

2–4: Slave

 When using the multi-pump control mode, the settings of each pump for Pr.10.36 cannot be the same.

10.37 Multi-Pump Fixed Time Circulation Period

Default: 60

Settings 1–65535 min.

 Fixed time circulation mode (alternative operation): Assume that when pump #1's operating time is longer than the setting for Pr.10.37, pump #1 stops, and then pump #2 activates, and so on.

Chapter 4 Parameters | VFD-EL-W

📖 Fixed quantity control (multi-pump operating at constant pressure): Assume that when the master pump's operating time is longer than the setting for Pr.10.37, the master pump and the slave pump switch alternatively.

📖 This parameter is only valid for master pump settings.

10.38 Pump Switching Start-up Frequency

Default: 60

Settings 0.00 Hz–Fmax

10.39 Pump Reaches Start-Up Frequency Detection Time

Default: 1.0

Settings 0.0–3600.0 sec.

10.40 Pump Switching Stop Frequency

Default: 48.00

Settings 0.00 Hz–Fmax

10.41 Pump Reaches Switching Stop Frequency Detection Time

Default: 1.0

Settings 0.0–3600.0 sec.

📖 This parameter is only valid for master pump settings.

📖 This parameter is only valid for fixed quantity control (multi-pump operating at constant pressure) mode.

📖 When master pump operation frequency \geq Pr.10.38 and the time exceeds the setting in Pr.10.39, activate the next pump; if the water is still insufficient, activate the third, the fourth pump according to the same conditions.

📖 When master pump operation frequency \leq Pr.10.40 and the time exceeds the setting in Pr.10.41, deactivate the first slave pump; if the master pump still fulfills the conditions, deactivate pump #2, pump #3 in sequence, and leave the master pump in operation only.

📖 Whether the master pump stops depends on the stopping detection function.

10.42 Pump's Frequency at Time-Out (Disconnection)

Default: 0.00

Settings 0.0–Fmax

📖 This parameter is only valid for Slave pump.

📖 Refer to Pr.09.02 (COM1 transmission fault handling) and Pr.09.03 (COM1 time-out detection) for the communication failure conditions and fault handling.





📖 If a disconnection occurs in the fixed quantity control (multi-pump operating at constant pressure), the frequency command of slave pump is Pr.10.42; the slave pump is in standalone mode after STOP command is given. (Set the RUN command and operation frequency by the slave pump parameters.)

10.43 Pump Fault Treatment

Default: 1

Settings bit0–bit2

📖 This parameter is only valid for master pump settings.

-  bit 0: When the operating pump is failed, whether it switches to an alternative pump or not
- 0: Stop all pump action
1: Switch to an alternative pump
- Example: bit0 = 0, when an error occurs to the running pump, all pumps stop.
bit0 = 1, when an error occurs to the running pump, switch the erroneous pump to an alternative one.
-  bit 1: During the operation, stop or standby after resetting from error
- 0: Set the erroneous pump to be in a standby status after reset (the pump receives the RUN command)
1: Set the erroneous pump to be in a stop status after reset (the pump does not receive the RUN command).
- Example: bit1 = 0, after you reset the erroneous pump, it can be set running through the controller
bit1 = 1, after you reset the erroneous pump, it cannot be set running through the controller until the master pump gives a STOP command.
-  bit 2: Whether the master pump receives the RUN command or not when the pump has an error
- 0: The master pump does not receive RUN command when an error occurs to the running pump
1: The master pump can choose an alternative pump to run when an error occurs to the running pump
- Example: bit 2 = 0: when an error occurs to Pump #2, the master pump does not accept the RUN command.
bit 2 = 1: when an error occurs to Pump #2, the master pump receives the RUN command and chooses to run with an alternative pump.
-  This parameter is only valid in AUTO mode.

10.44 Pump Start-Up Sequence Selection

Default: 0

Settings 0–1

0: By pump ID
1: By the operating time

 0: By pump ID (1 → 2 → 3 → 4 → 1)

 1: By the shortest operating time

10.45 Pump Alternative Operation Time Setting

Default: 60.0

Settings 0.0–360.0 sec.

 Sets the time for switching the master pump and the slave pump. This parameter is only valid for master pump settings.

10.46

– Reserved

10.48

↗ 10.49 Setting Method for Pr.10.12

Default: 0

Settings 0: Use the existed setting (default), judging by the feedback deviation
1: Set the low water pressure percentage (%), check for any fault by the feedback physical quantity

- 📖 When the pressure sensor is set to 10 kg, set Pr.10.49 = 0 and Pr.10.12 = 10.0% (that is, deviation=1 kg), and if the set point = 3 kg and feedback < 2 kg, then the AC motor drive follows the setting for Pr.10.20.
- 📖 When the pressure sensor is set to 10 kg, set Pr.10.49 = 1 and Pr.10.12 = 10.0% (that is, deviation=1 kg), and if the set point = 3 kg and feedback < 1 kg, then the AC motor drive follows the setting for Pr.10.20.

↗ 10.50 Number of Times of Restart after Fault

Default: 0

Settings 0–65535 times

- 📖 Sets the number of times of restart after Fault when Pr.10.20 = 4.

4-4 Adjustment and Application

Using PID control in a constant pressure pump feedback application:

Set the application constant pressure value (bar) as PID set point. The pressure sensor sends the actual value as the PID feedback value. After comparing the PID set point and PID feedback, an error displays. The PID controller calculates the output by using proportional gain (P), integral time (I) and differential time (D) to control the pump. It controls the drive to use a different pump speed and achieves constant pressure control.

- The general pressure measuring range of the pressure sensor is 0–10 bar, correspond to 4–20 mA as the drive feedback signal.
- Pressure conversion relation: 0.1 Mpa = 1 bar = 1 kgf-cm²

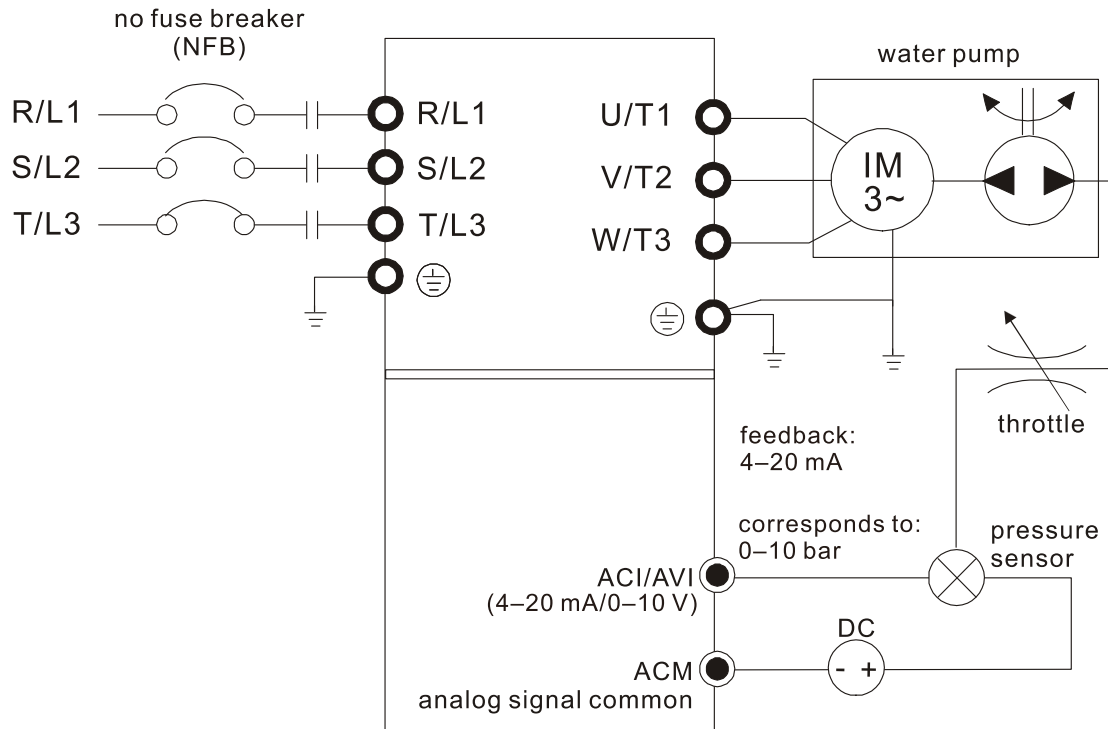

STEP	Functions	Related Parameters	Description
1	PID Setting	Pr.10.00 PID Set Point Selection Pr.10.01 Input Terminal for PID Feedback	Multi-pump system: the pressure feedback signal only connects to the Master pump, so set the PID for the master pump only.
2	P, I, D Gain	Pr.10.02 (P) Pr.10.03 (I) Pr.10.04 (D)	Multi-pump system: Each drive has a PID controller. Set the parameters for all drives.
3	Acceleration and deceleration setting	Pr.01.09 Acceleration Time 1 Pr.01.10 Deceleration Time 1	Multi-pump system: set the acceleration and deceleration time for each drive
4	Keypad multi-function display	Pr.00.04 Content of Multi-function Display (User-Defined) 5 (Display PID analog feedback signal (b)) 8 (Display the setting values for PID control and feedback signal)	1. The VFD-EL-W keypad displays the PID setting and physical quantity feedback values. Refer to the following description for parameters settings.
5	Correspondence setting of frequency and physical quantity	Pr.00.13 User-defined value Pr.00.14 Decimal Places for User-Defined Value Pr.10.18 PID Feedback Physical Quantity	2. Multi-pump system: set the above related parameters of keypad for each drive.

Chapter 4 Parameters | VFD-EL-W

STEP	Functions	Related Parameters	Description
6	Stopping detection function	Pr.10.22 Set point deviation level Pr.10.23 Set Point Stop Detection Time Pr.01.12 Deceleration Time 2	Multi-pump system: all drives must have the stopping detection function. Set the related parameters for all drives.
7	Liquid leakage	Pr.10.24 Deviation Level of Liquid Leakage Pr.10.25 Liquid Leakage Change Detection Pr.10.26 Liquid Leakage Deviation Level Detection	All drives must have the restart function for liquid leakage. Set the related parameters for all drives.
8	Sleep/ wake up function	Pr.10.14 Sleep Detection Time Pr.10.15 Sleep Frequency Pr.10.16 Wake-up Frequency	The multi-pump system has its own wheel pump control function, the sleep function is recommended to use only for single pump drive function.
9	Multi-functional pump function	Refer to the following description in "Multi-communication application setting case" for parameters setting according to the functions of the Master and Slave pumps.	

Related parameters for PID set point and feedback value corresponds to the physical quantity

00.03 Start-up Display

Default: 0

- Settings
- 0: F (frequency command)
 - 1: H (output frequency)
 - 2: A (output current)
 - 3: U (user-defined)
 - 4: FWD/REV command

Determines the start-up display page after power is applied to the drive.

Gets into the self-check state first when the drive starts-up, after displays "Pon" and flashes for 5 sec., the drive turns to start-up page.

00.04 Content of Multi-function Display (User-Defined)

Default: 0

- Settings
- 5: Display the PID feedback value after enabling the PID function in %
 - 8: Display the setting value and the feedback of PID control (P)
 - 9: Display AVI analog input terminal signal (1.) (Unit: %)
 - 10: Display AVI analog input terminal signal (1.) (Unit: %)

When Pr.00.03 is set to 3, use Pr.00.04 to select the displayed content as needed.

When Pr.00.04 = 5, the displayed PID feedback value is the percentage (%) of the terminal measurement range.

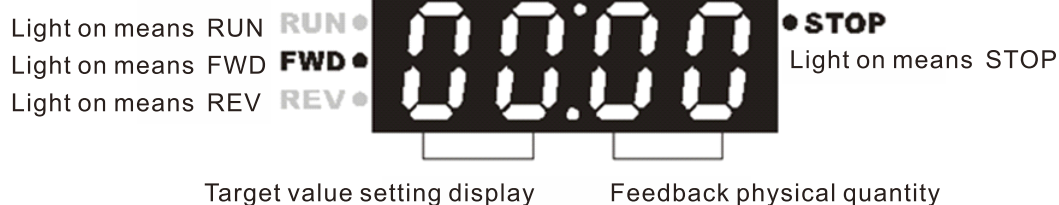

- 📖 In the flow control occasions such as constant pressure water pumps using PID control, set Pr.00.03 = 3 and Pr.00.04 = 8. When the drive reboots after powered off, the start-up screen displays 00:00 (as shown in the figure above). The displayed value on the left of “:” is the physical quantity of PID target value; on the right of “:” shows the sensor output value (0–10V/4–20 mA) corresponding to the actual physical quantity.
- 📖 Refer to Pr.10.00 to set the target value; and Pr.10.18 to set the feedback value.
- 📖 If the set and displayed target value directly correspond to physical quantities such as pressure, temperature, flow, etc., you also need to set Pr.00.13 and Pr.00.14 at the same time.

00.13 User-defined Value

Default: 0

Settings 0–9999

- 📖 Corresponds to the maximum operation frequency (Pr.01.00)
- 📖 When Pr.00.13 is not set to zero, “F” automatically disappears in the frequency setting page, and the displayed last digit blinks. The Up/down key, multi-step speed and JOG function on the keypad all changes ranges according to Pr.00.13.
- 📖 When Pr.00.13 is not set to zero, and the frequency source is communication, use Pr.02.18 to change the frequency command instead of using communication address 2001H.

00.14 Decimal Places for User-Defined Value

Default: 0

Settings 0–3

- 📖 Sets the digital places for Pr.00.13.
- 📖 For example: if the corresponding physical quantity such as pressure is to be set as 10.0 bar, you need to set Pr.00.13 to 100, and set Pr.00.14 to 1. Pressure conversion relation: 0.1 Mpa = 1 bar = 1 kgf-cm²

10.00 PID Set Point Selection

Default: 0

Settings

- 0: PID function disabled
- 1: Digital keypad
- 2: Reserved
- 3: Reserved
- 4: Set by Pr.10.11

- 📖 Set Pr.00.03 = 3 and Pr.00.04 = 8 for feedback value to display the PID set point on the control panel at the same time.
- 📖 When Pr.10.00 is set to 1 and operated by the keypad, adjust the set point by pressing the up/down keys directly on any display interface if you need to set the set point.
- 📖 When Pr.10.00 is set to 4, the setting range of Pr.10.11 is limited by the maximum operating frequency of Pr.01.00. The maximum frequency value of Pr.01.00 is the maximum value of the physical quantity to the set point corresponds to the maximum range of the physical quantity measured by the sensor (set in Pr.10.18).
- 📖 If the set and displayed target value directly correspond to physical quantities such as pressure,

Chapter 4 Parameters | VFD-EL-W

temperature, flow, etc., you also need to set Pr.00.13 and Pr.00.14 at the same time. For example, when the maximum range of the set point set as 16.0 bar, you also need to set Pr.00.13 = 160, 00.14 = 1.

📖 The target physical quantity corresponding to the frequency set by Pr.10.11 = (Pr.10.11/ Pr.01.00) × Pr.00.13 × 10^{-(Pr.00.14)}. For example, Pr.10.11 = 20 Hz, Pr.01.00 = 50 Hz, Pr.00.13 = 160, Pr.00.14 = 1, then the target physical quantity = 20 / 50 × 160 × 0.1 = 8.0.

📖 The following table shows the set point physical quantity and the operating frequency of the drive, sensor feedback value correspond to the physical quantity, set point setting method and relationship.

Corresponded Relation	Set Point Physical Quantity	Corresponded Drive Operation Frequency	Sensor Feedback Value Corresponding to the Physical Quantity	PID Set Point	
				Pr.10.00 = 1 Keypad up/down keys	Pr.10.00 = 4 Pr.10.11 = 50
Parameter Setting	Pr.00.13 = 160 Pr.00.14 = 1	Pr.00.02 = 9 Pr.01.00 = 50	Pr.10.18 = 16.0	Pr.10.00 = 1 Keypad up/down keys	Pr.10.00 = 4 Pr.10.11 = 50
Lower Limit	0	0	0	0	0
Upper Limit	16.0	50	16.0	16.0	16.0

10.01 Input Terminal for PID Feedback

Default: 0

- Settings
- 0: Positive PID feedback from external terminal AVI (0–10 V_{DC})
 - 1: Negative PID feedback from external terminal AVI (0–10 V_{DC})
 - 2: Positive PID feedback from external terminal ACI (4–20 mA)
 - 3: Negative PID feedback from external terminal ACI (4–20 mA)

- 📖 Select the input terminal as the PID detection terminal, and note that the master frequency source cannot be the same.
- 📖 Negative feedback: Error = Target value (set point) – Feedback. Use negative feedback when the detection value increases if the output frequency increases.
- 📖 Positive feedback: Error = - Target value (set point) + Feedback. Use positive feedback when the detection value decreases if the output frequency increases.

10.18 PID Feedback Physical Quantity

Default: 99.9

Settings 1.0–99.9

- 📖 Pr.10.18 set value is the conversion base of the corresponding relationship between the sensor feedback analog quantity and the feedback physical quantity, and usually set to the maximum value of the sensor input range physical quantity.
- 📖 Select Pr.10.01 value according to the sensor output signal type 0–10 V/ 4–20 mA and specific control requirements.
- The sensor output range is 4–20 mA, the feedback physical quantity = (sensor measurement feedback current - 4) ÷ (20 - 4) × Pr.10.18.
 - The sensor output range is 0–10 mA, the feedback physical quantity = (sensor measurement feedback voltage - 0) ÷ (10 - 0) × Pr.10.18.

- For example, the pressure sensor range is 0–16.0 bar, and the corresponding output range is 4–20 mA. When the Pr.10.18 is set to 16.0 and the sensor's actual measurement output is 12 mA, the actual feedback physical quantity = $(12 - 4) \div (20 - 4) \times 16.0 = 8.0$ bar, the corresponding relationship is shown in the table below.

📖 Set Pr.00.03 = 3 and Pr.00.04 = 8 to display the actual feedback physical quantity on the digital keypad. And the physical quantity correspond to the feedback value displayed on the right side of ":". Refer to Pr.00.04 description for more details.

Corresponded Relation	Sensor Feedback Value		Feedback Value Corresponds to the Physical Quantity
	ACI	AVI	
Parameter Setting	Pr.10.01 =- 2 or 3	Pr.10.01 =- 0 or 1	Pr.10.18 = 16.0
Lower Limit	4 mA	0V	0 bar
Medium value	12 mA	5V	8.0 bar
Upper Limit	20 mA	10V	16.0 bar

Multi-communication Application Setting Case

01 Pr.10.35 = 1 Fixed time circulation (alternative operation)

- Enables four pumps to operate alternatively by time to extend the life span.
- Keeps the water pressure at 3 kg in a water system with constant pressure.

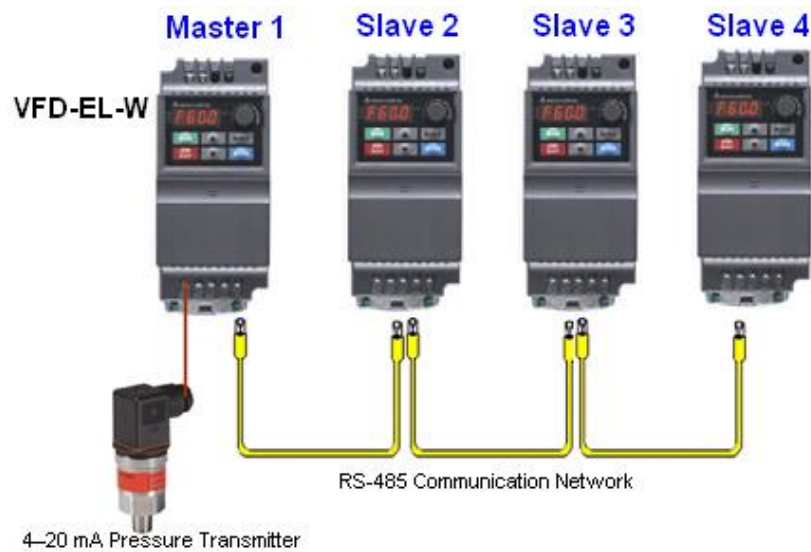

Related parameters (Pr.10.35 = 1)

Pr.	Function	Setting Range	Default	User's Master	User's Slave	Note
00.03	Start-up Display	0: F (frequency command) 1: H (output frequency) 2: A (output current) 3: U (user-defined) 4: FWD/REV command	0	3	3	
00.04	Content of Multi-function Display (User-Defined)	0: Display the content of user-defined unit 1: Display counter value (c) 2: Display the status of multi-function input terminal (d) 3: Display the drive's DC bus voltage (u) 4: Display the drive's output voltage (E) 5: Display PID analog feedback signal (b) 6: Display the drive's power factor angle (n) 7: Display the drive's output power (P) 8: Display the setting value and the feedback of PID control (P) 9: Display AVI analog input terminal signal (V) (I) 10: Display ACI analog input terminal signal (mA/V) (i) 11: Display IGBT temperature (°C) (h)	0	8	8	
00.13	User-Defined Value (Max. operation frequency)	0-9999	0	100	100	Sets the constant pressure control to correspond to the largest physical quantity and the decimal place. The number displayed is 10.0 currently.
00.14	Decimal Places for User-Defined Value	0-3	0	01	01	

Chapter 4 Parameters | VFD-EL-W

Pr.	Function	Setting Range	Default	User's Master	User's Slave	Note
01.00	Max. Operation Frequency	50.00–400.0 Hz	60.00	60.00	60.00	Set the parameters according to the specifications of pumps.
01.01	Motor Rated Frequency	0.10–400.0 Hz	60.00	60.00	60.00	
01.02	Motor Rated Voltage	230V models: 0.1–255.0 V 460V models: 0.1–510.0 V	220.0 400.0	220.0 400.0	220.0 400.0	
↗ 01.09	Acceleration Time 1	0.1–600.0 sec./ 0.01–600.00 sec.	10.0	0.5	0.5	Adjust the parameter according to customer's applications
↗ 01.10	Deceleration Time 1	0.1–600.0 sec./ 0.01–600.00 sec.	10.0	5.0	5.0	
↗ 01.12	Deceleration Time 2	0.1–600.0 sec./ 0.01–600.00 sec.	10.0	3.0	3.0	The time for the drive decelerating to stop when the pressure reaches the setting value.
↗ 02.00	First Master Frequency Command Source	0: Digital keypad 1: External terminal AVI analog signal DC 0–10V 2: External terminal ACI analog signal DC 4–20 mA 3: RS-485 communication input 4: Digital keypad potentiometer knob	0	2	2	Adjust the parameter according to customer's applications
↗ 02.01	Operation Command Source	0: Digital keypad 1: External terminals, STOP key is valid 2: External terminals, STOP key is invalid 3: RS-485 communication, STOP key is valid 4: RS-485 communication, STOP key is invalid	0	0	0	Adjust the parameter according to customer's applications
10.35	Multi-Pump Operation Mode	0: Disable 1: Fixed time circulation (alternative operation) 2: Fixed quantity control (multi-pump operating at constant pressure)	0	1	1	
10.36	Multi-Pump ID	0: Disable multi-pump function 1: Master 2–4: Slave	0	1	2	
10.37	Multi-Pump Fixed Time Circulation Period	1–65535 min.	60	1	1	
10.42	Pump's Frequency at Time-Out (Disconnection)	0.0–Fmax	0.00	60	60	
10.43	Pump Fault Treatment bit 0: When the operating pump is failed, whether it switches to an alternative pump or not	0: Stop all pump action 1: Switch to an alternative pump	1	1	1	000 = 0 001 = 1 010 = 2 011 = 3 100 = 4 101 = 5 110 = 6 111 = 7
	bit 1: During the operation, stop or standby after resetting from error	0: Standby after resetting 1: Stop after resetting				
	bit 2: Whether the system can run or not when the	0: 0: The system cannot activate 1: 1: The system selects another pump to operate				

Chapter 4 Parameters | VFD-EL-W

Pr.	Function	Setting Range	Default	User's Master	User's Slave	Note
	pump has an error					
10.44	Pump Start-Up Sequence Selection	0: By pump ID 1: According to the operating time	0	1	1	Adjust the parameter according to customer's applications
10.45	Pump Alternative Operation Time Setting	0.0–360.0 sec.	60.0	60.0	60.0	Adjust the parameter according to customer's applications
10.00	PID Set Point Selection	0: PID function disabled 1: Digital keypad 2: Reserved 3: Reserved 4: PID reference target value (Pr.10.11)	0	1	1	Adjust the parameter according to customer's applications
10.01	Input Terminal for PID Feedback	0: Positive PID feedback from external terminal AVI (0–10 V _{DC}) 1: Negative PID feedback from external terminal AVI (0–10 V _{DC}) 2: Positive PID feedback from external terminal ACI (4–20 mA) 3: Negative PID feedback from external terminal ACI (4–20 mA)	0	3	3	
↗ 10.02	Proportional Gain (P)	0.0–10.0	1.0	1.2	1.2	Adjust the parameter according to customer's applications
↗ 10.03	Integral Time (I)	0.00–100.0 sec.	1.00	0.7	0.7	
↗ 10.04	Differential Time (D)	0.00–1.00 sec.	0.00	-	-	
10.12	PID Feedback Signal Error Deviation Level	1.0–50.0%	10.0	5	5	When the pressure feedback is < 0.5 kg and time > 15 sec., follow the settings for Pr.10.20.
10.13	PID Feedback Signal Error Deviation Detection Time	0.1–300.0 sec.	5.0	15	15	
10.18	PID Feedback Physical Quantity	1.0–99.9	99.9	10	10	Sets the maximum feedback of PID physical quantity value to be 10 kg.
10.19	PID Calculation Mode Selection	0: Serial connection 1: Parallel connection	00	01	01	The parallel PID calculation mode applies for the constant pressure water supply control.
10.20	PID Error Deviation Treatment	0: Warn and continue operation (no treatment) 1: Coast to stop 2: Ramp to stop 3: Ramp to stop and restart after Pr.10.21 delay time	0	3	3	When there is water shortage or unusual pressure feedback, the pump stops running for 1800 sec. (30 minutes) until the pressure feedback is back to normal.
10.21	PID Error Deviation Restart Delay Time	1–9999 sec.	60	1800	1800	
↗ 10.22	Set Point Deviation Level	0–100%	0	5	5	If the feedback value and the set point deviation are both is 0.15 kg (3 kg × 5% = 0.15 kg), that is, when feedback value is ≥ 2.85 kg and time > 10 seconds, the AC
10.23	Set Point Stop Detection Time	1–9999 sec.	10	10	10	

Chapter 4 Parameters | VFD-EL-W

Pr.	Function	Setting Range	Default	User's Master	User's Slave	Note
						motor drive starts to decelerate to stop. The deceleration time is according to the Deceleration Time 2 set in Pr.01.12. When the feedback value is less than 2.85 kg, the drive starts to run.
↗ 10.24	Deviation Level of Liquid Leakage	0–50%	0	33	33	Liquid Leakage: Assume that when the drive does not run and is in a constant pressure status, the variation of the feedback value is less than 0.12 kg (3 kg × 4% = 0.12 kg) within 2 second. When the feedback value continues to decrease to make the deviation of the set point be less than 0.99 kg (3 kg × 33% = 0.99 kg), that is, when the feedback value is less than 2.01 kg, the drive starts to run.
↗ 10.25	Liquid Leakage Change Detection	0: Disable 0–100%	0	4	4	
↗ 10.26	Liquid Leakage Change Detection Time	0: Disable 0.1–10.0 sec.	0.5	2	2	Liquid Usage after Liquid Leakage: When the drive does not run and is in a constant pressure status, the variation of the feedback value is higher than 0.12 kg within 2 seconds, the drive starts to run.

Chapter 4 Parameters | VFD-EL-W

02 Pr.10.35 = 2 Fixed quantity control (multi-pump operating at constant pressure)

Related parameters (Pr.10.35 = 2)

Pr.	Function	Setting Range	Default	User's Master	User's Slave	Note
00.03	Start-up Display	0: F (frequency command) 1: H (output frequency) 2: A (output current) 3: U (user-defined) 4: FWD/REV command	0	3	3	
00.04	Content of Multi-function Display (User-Defined)	0: Display the content of user-defined unit 1: Display counter value (c) 2: Display the status of multi-function input terminal (d) 3: Display the drive's DC bus voltage (u) 4: Display the drive's output voltage (E) 5: Display PID analog feedback signal (b) 6: Display the drive's power factor angle (n) 7: Display the drive's output power (P) 8: Display the setting value and the feedback of PID control (P) 9: Display AVI analog input terminal signal (V) (l) 10: Display ACI analog input terminal signal (mA/V) (i) 11: Display IGBT temperature (°C) (h)	0	8	8	
00.13	User-Defined Value (Max. operation frequency)	0–9999	0	100	100	Sets the constant pressure control to correspond to the largest physical quantity and the decimal place. The number displayed is 10.0 currently.
00.14	Decimal Places for User-Defined Value	0–3	0	1	1	
01.00	Max. Operation Frequency	50.00–400.0 Hz	60.00	60	60	Set the parameters according to the specifications of pumps.
01.01	Motor Rated Frequency	0.10–400.0 Hz	60.00	60.00	60.00	
01.02	Motor Rated Voltage	230V models: 0.1–255.0 V 460V models: 0.1–510.0 V	220.0 400.0	220.0 400.0	220.0 400.0	
01.09	Acceleration Time 1	0.1–600.0 sec./ 0.01–600.00 sec.	10.0	0.5	0.5	Adjust the parameter according to customer's applications
01.10	Deceleration Time 1	0.1–600.0 sec./ 0.01–600.00 sec.	10.0	5.0	5.0	
01.12	Deceleration Time 2	0.1–600.0 sec./ 0.01–600.00 sec.	10.0	3.0	3.0	The time for the drive decelerating to stop when the pressure reaches the setting value.
02.00	First Master Frequency Command Source	0: Digital keypad 1: External terminal AVI analog signal DC 0–10V 2: External terminal ACI analog signal DC 4–20 mA 3: RS-485 communication input 4: Digital keypad potentiometer knob	0	2	2	Adjust the parameter according to customer's applications

Pr.	Function	Setting Range	Default	User's Master	User's Slave	Note
02.01	Operation Command Source	0: Digital keypad 1: External terminals, STOP key is valid 2: External terminals, STOP key is invalid 3: RS-485 communication, STOP key is valid 4: RS-485 communication, STOP key is invalid	0	0	0	Adjust the parameter according to customer's applications
10.35	Multi-Pump Operation Mode	0: Disable 1: Fixed time circulation (alternative operation) 2: Fixed quantity control (multi-pump operating at constant pressure)	0	2	2	
10.36	Multi-Pump ID	0: Disable multi-pump function 1: Master 2-4: Slave	0	1	2	
10.37	Multi-Pump Fixed Time Circulation Period	1-65535 min.	60	1	1	
10.42	Pump's Frequency at Time-Out (Disconnection)	0.0-Fmax	0.00	60	60	
10.43	Pump Fault Treatment bit 0: When the operating pump is failed, whether it switches to an alternative pump or not bit 1: During the operation, stop or standby after resetting from error bit2 Whether the system can run or not when the pump has an error	0: Stop all pump action 1: Switch to an alternative pump 0: Standby after resetting 1: Stop after resetting 0: The system cannot activate 1: The system selects another pump to operate	1	1	1	000 = 0 001 = 1 010 = 2 011 = 3 100 = 4 (bit2: 1, bit1: 0, bit0: 0) 101 = 5 110 = 6 111 = 7 (bit 2 <-- bit 1 <-- bit 0)
10.44	Pump Start-Up Sequence Selection	0: By pump ID 1: According to the operating time	0	1	1	Adjust the parameter according to customer's applications
10.45	Pump Alternative Operation Time Setting	0.0-360.0 sec.	60.0	60.0	60.0	Adjust the parameter according to customer's applications
10.00	PID Set Point Selection	0: PID function disabled 1: Digital keypad 2: Reserved 3: Reserved 4: PID reference target value (Pr.10.11)	0	1	1	Adjust the parameter according to customer's applications
10.01	Input Terminal for PID Feedback	0: Positive PID feedback from external terminal AVI (0-10 V _{DC}) 1: Negative PID feedback from external terminal AVI (0-10 V _{DC}) 2: Positive PID feedback from external terminal ACI (4-20 mA) 3: Negative PID feedback from external terminal ACI (4-20	0	3	3	

Chapter 4 Parameters | VFD-EL-W

Pr.	Function	Setting Range	Default	User's Master	User's Slave	Note
		mA)				
10.02	Proportional Gain (P)	0.0–10.0	1.0	1.2	1.2	Adjust the parameter according to customer's applications
10.03	Integral Time (I)	0.00–100.0 sec.	1.00	0.7	0.7	
10.04	Differential Time (D)	0.00–1.00 sec.	0.00	-	-	
10.12	PID Feedback Signal Error Deviation Level	1.0–50.0%	10.0	5	5	When the pressure feedback is < 0.5 kg and time > 15 sec., follow the settings for Pr.10.20.
10.13	PID Feedback Signal Error Deviation Detection Time	0.1–300.0 sec.	5.0	15	15	
10.18	PID Feedback Physical Quantity	1.0–99.9	99.9	10	10	Sets the maximum feedback of PID physical quantity value to be 10 kg.
10.19	PID Calculation Mode Selection	0: Serial connection 1: Parallel connection	0	1	1	The parallel PID calculation mode applies for the constant pressure water supply control.
10.20	PID Error Deviation Treatment	0: Warn and continue operation (no treatment) 1: Coast to stop 2: Ramp to stop 3: Ramp to stop and restart after Pr.10.21 delay time	0	3	3	When there is water shortage or unusual pressure feedback, the pump stops running for 1800 sec. (30 minutes) until the pressure feedback is back to normal.
10.21	PID Error Deviation Restart Delay Time	1–9999 sec.	60	1800	1800	
10.22	Set Point Deviation Level	0–100%	0	5	5	If the feedback value and the set point deviation are both is 0.15 kg (3 kg × 5% = 0.15 kg), that is, when feedback value is ≥ 2.85 kg and time > 10 seconds, the AC motor drive starts to decelerate to stop. The deceleration time is according to the Deceleration Time 2 set in Pr.01.12. When the feedback value is less than 2.85 kg, the drive starts to run.
10.23	Set Point Stop Detection Time	1–9999 sec.	10	10	10	
10.24	Deviation Level of Liquid Leakage	0–50%	0	33	33	Liquid Leakage: Assume that when the drive does not run and is in a constant pressure status, the variation of the feedback value is less than 0.12 kg (3 kg × 4% = 0.12 kg) within 2 second. When the feedback value continues to decrease to make the deviation of the set point be less than 0.99 kg (3 kg × 33% = 0.99 kg), that is, when the feedback value is less than 2.01 kg, the drive starts to run.
10.25	Liquid Leakage Change Detection	0: Disable 0–100%	0	4	4	
10.26	Liquid Leakage Change Detection Time	0: Disable 0.1–10.0 sec.	0.5	2	2	

Chapter 4 Parameters | VFD-EL-W

Pr.	Function	Setting Range	Default	User's Master	User's Slave	Note
						Liquid Usage after Liquid Leakage: When the drive does not run and is in a constant pressure status, the variation of the feedback value is higher than 0.12 kg within 2 seconds, the drive starts to run.

Optional Accessories for Multi-pumps Alternative Operation

When you use the multi-pump operation, pay attention to the following wirings.

1. Use a RJ45 cable (8 pin, Internet cable) without an adapter. Simply connect the master/slave communication port. If there are more than two pumps, use RMKE-HUB01 to connect RJ45.
2. Use a RJ11 (6 pin) cable with an adapter to connect the master/ slave communication port.
3. You can also directly connect to SG+/SG- lock wire terminals without using accessories to form multiple communication alternate operation systems.

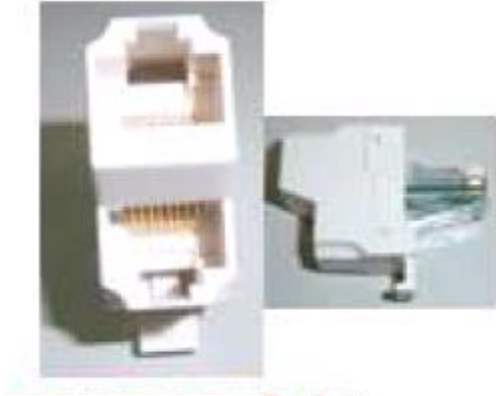

RMKE-HUB01

RS-485 One-wire to Two-wire



VFD-CMD04

RS-485 RJ11 Four-port communication
breakout box

Chapter 5 Troubleshooting

5-1 Over-Current (oc)

5-2 Over-Voltage (ov)

5-3 Low Voltage (Lv)

5-4 Overheat (oH1)

5-5 Overload (oL)

5-6 Keypad Display is Abnormal

5-7 Phase Loss (PHL)

5-8 Motor Does Not Run

5-9 Motor Speed Cannot be Changed

5-10 Motor Stalls During Acceleration

5-11 The Motor Does Not Run as Expected

5-12 Electromagnetic/Induction Noise

5-13 Operating Environment Condition

5-14 Affecting Other Machines

Chapter 5 Troubleshooting | VFD-EL-W

5-1 Over-Current (oc)

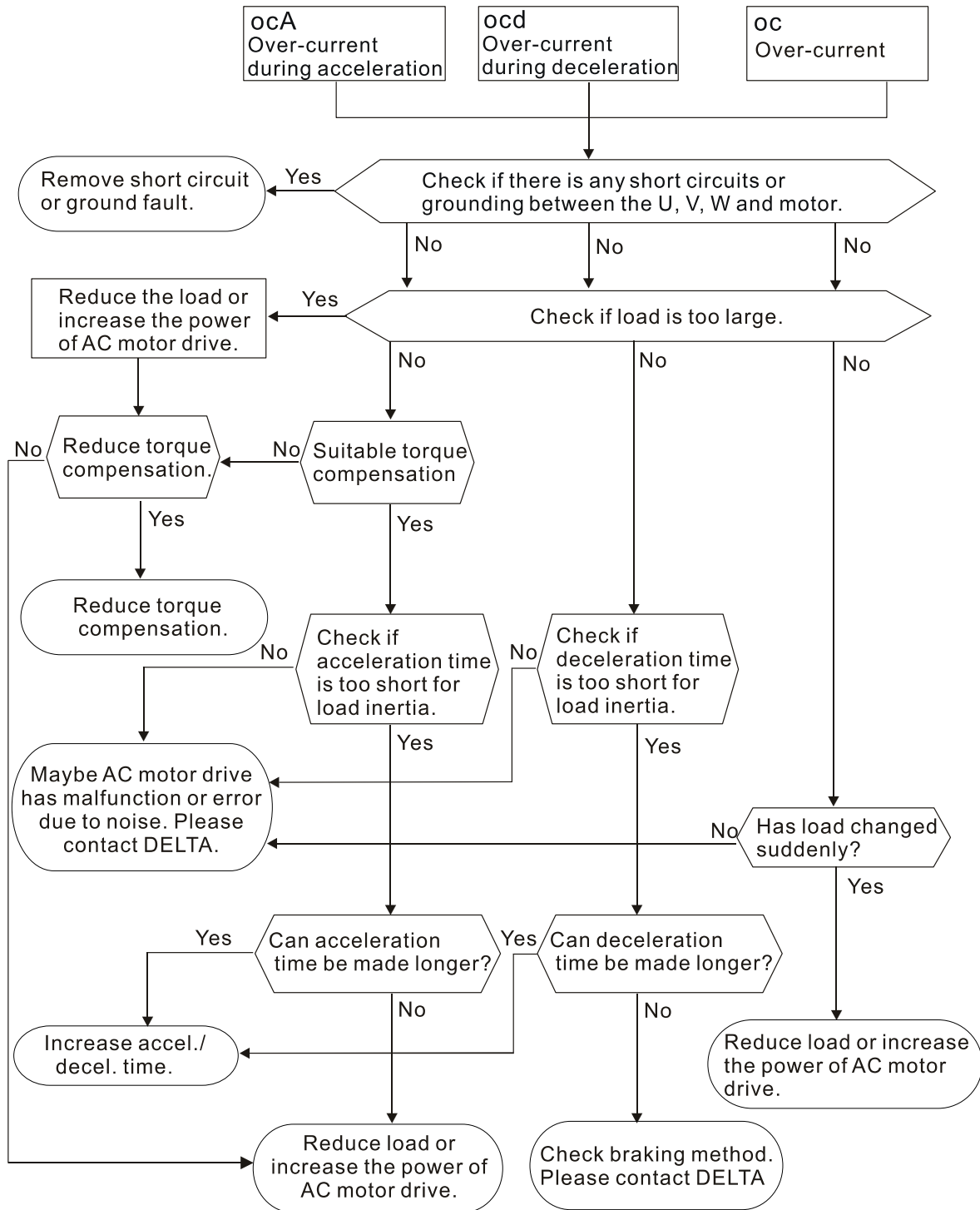

5-2 Over-Voltage (ov)

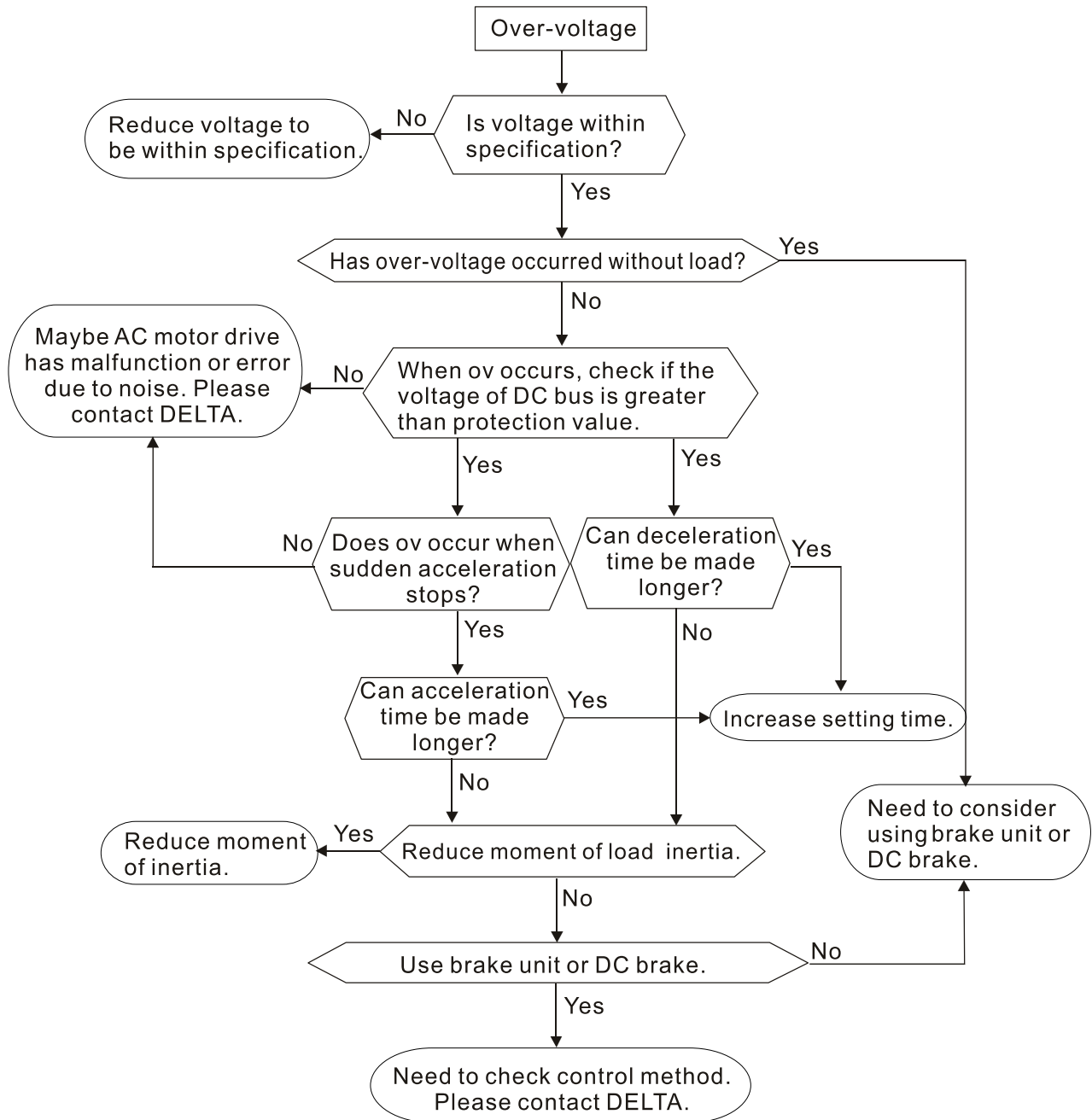

Chapter 5 Troubleshooting | VFD-EL-W

5-3 Low Voltage (Lv)

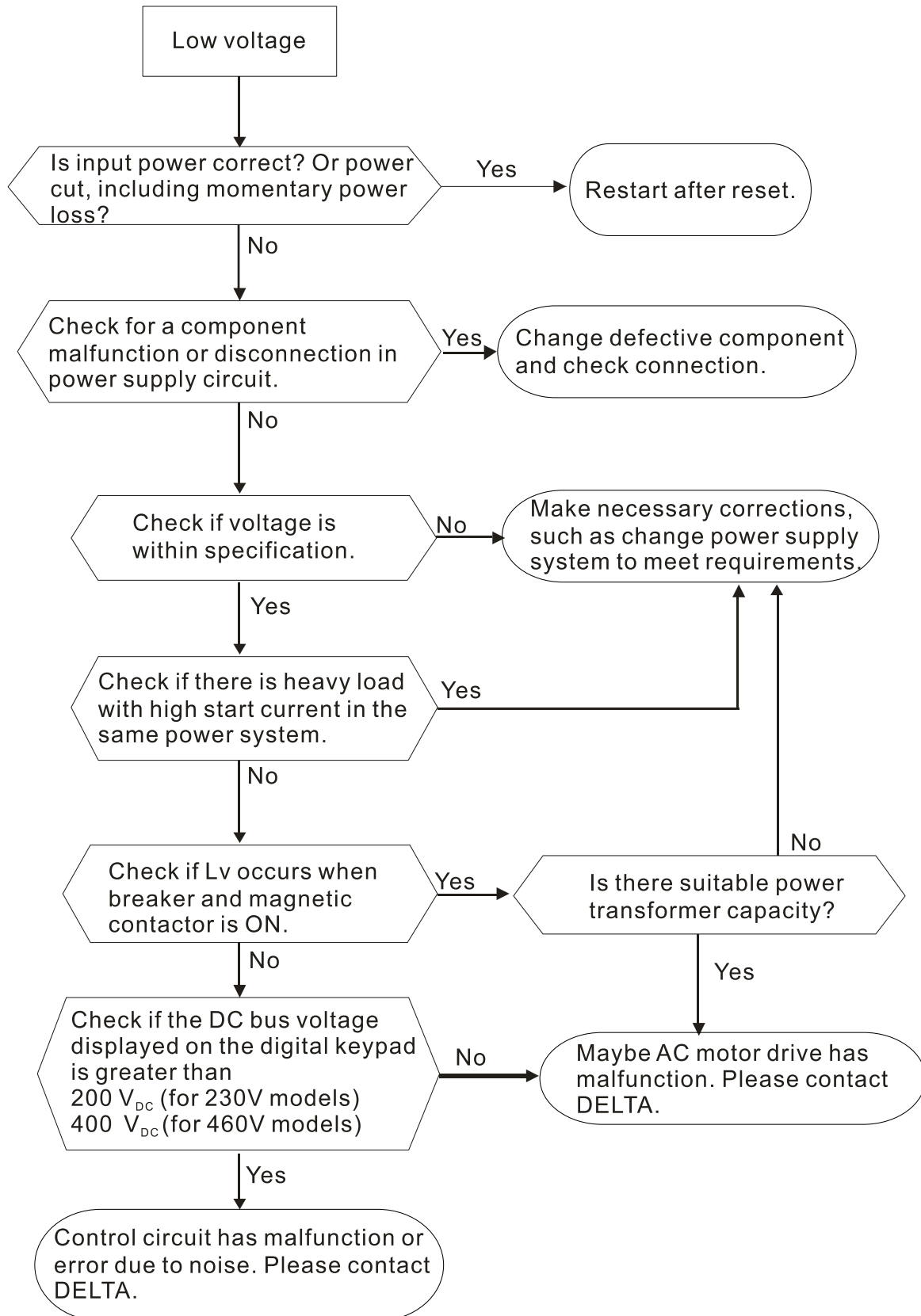

5-4 Overheat (oH1)

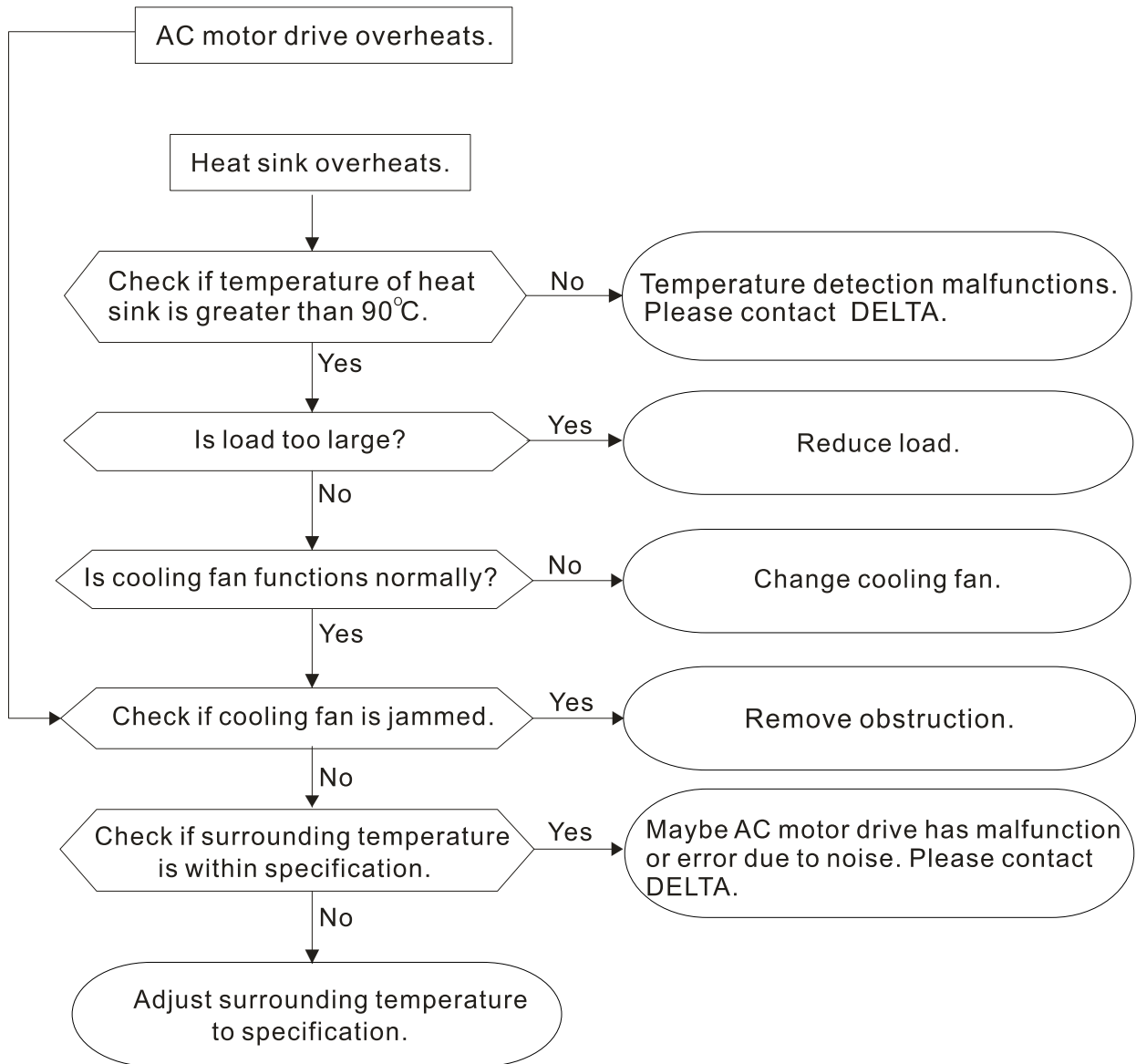

Chapter 5 Troubleshooting | VFD-EL-W

5-5 Overload (oL)

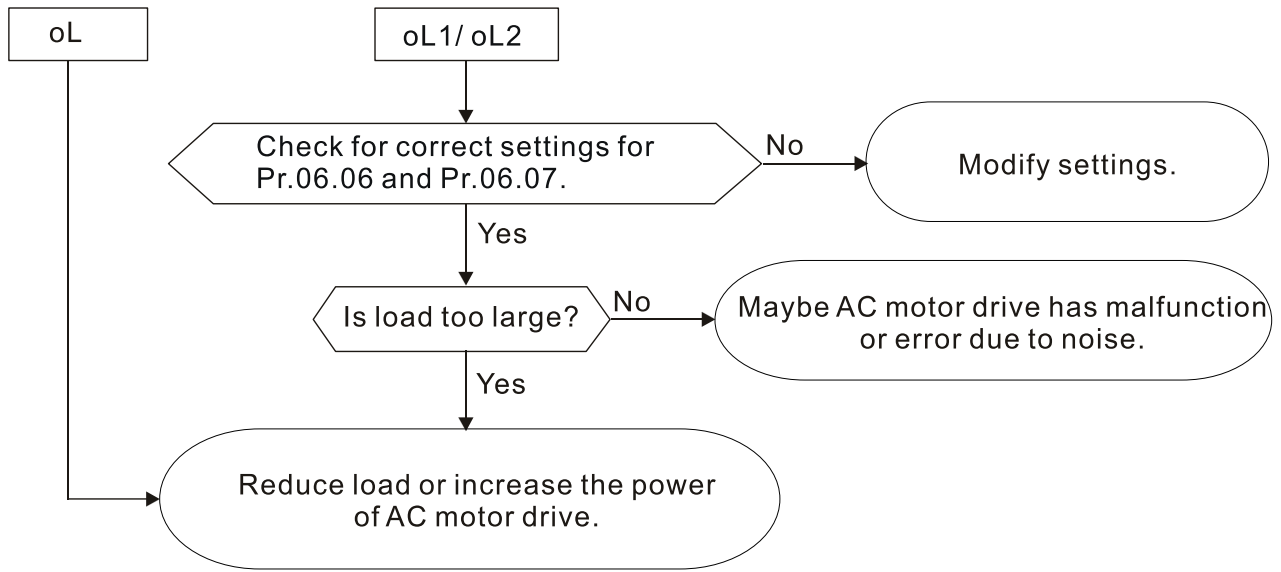

5-6 Keypad Display is Abnormal

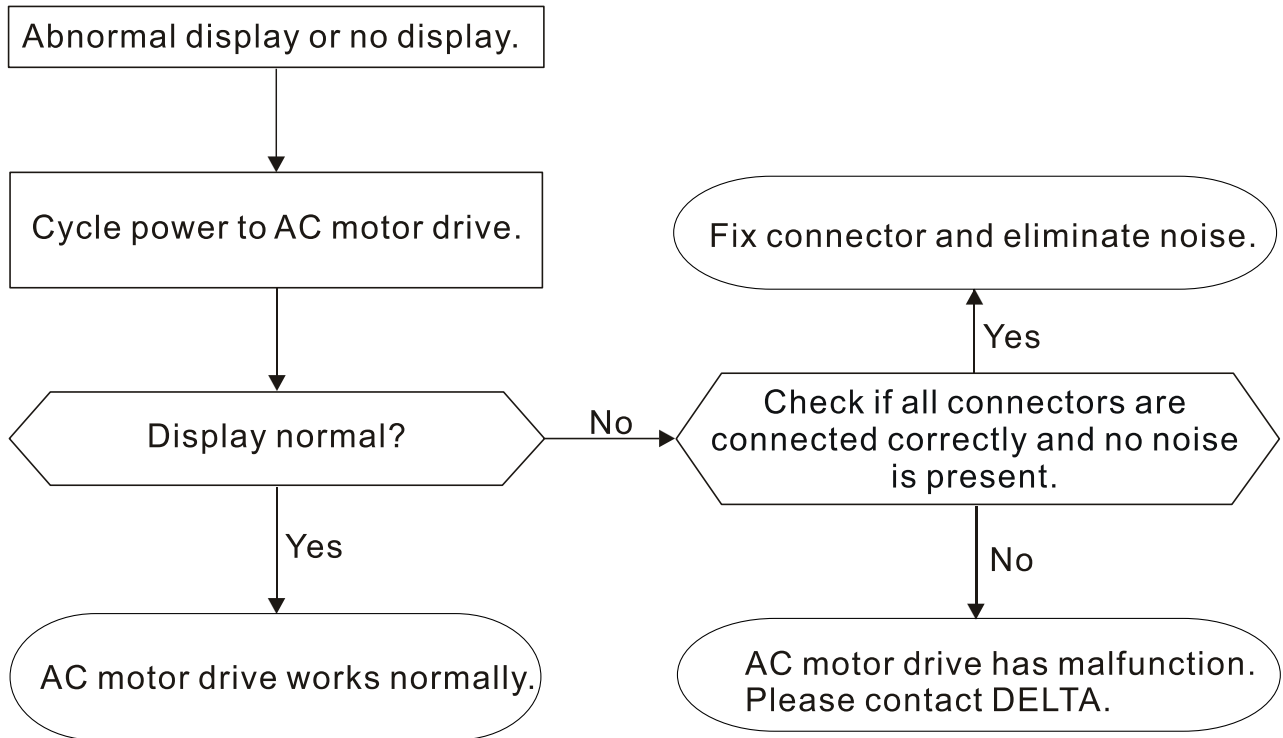

Chapter 5 Troubleshooting | VFD-EL-W

5-7 Phase Loss (PHL)

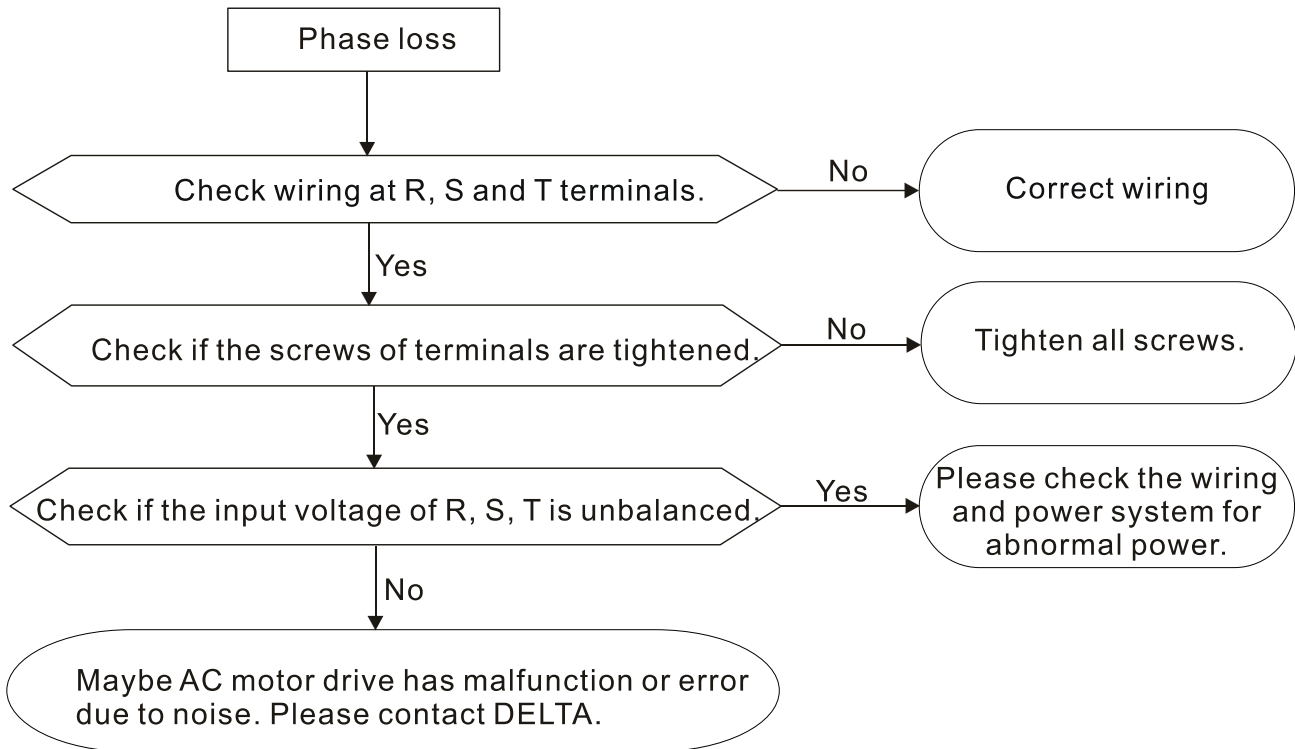

5-8 Motor Does Not Run

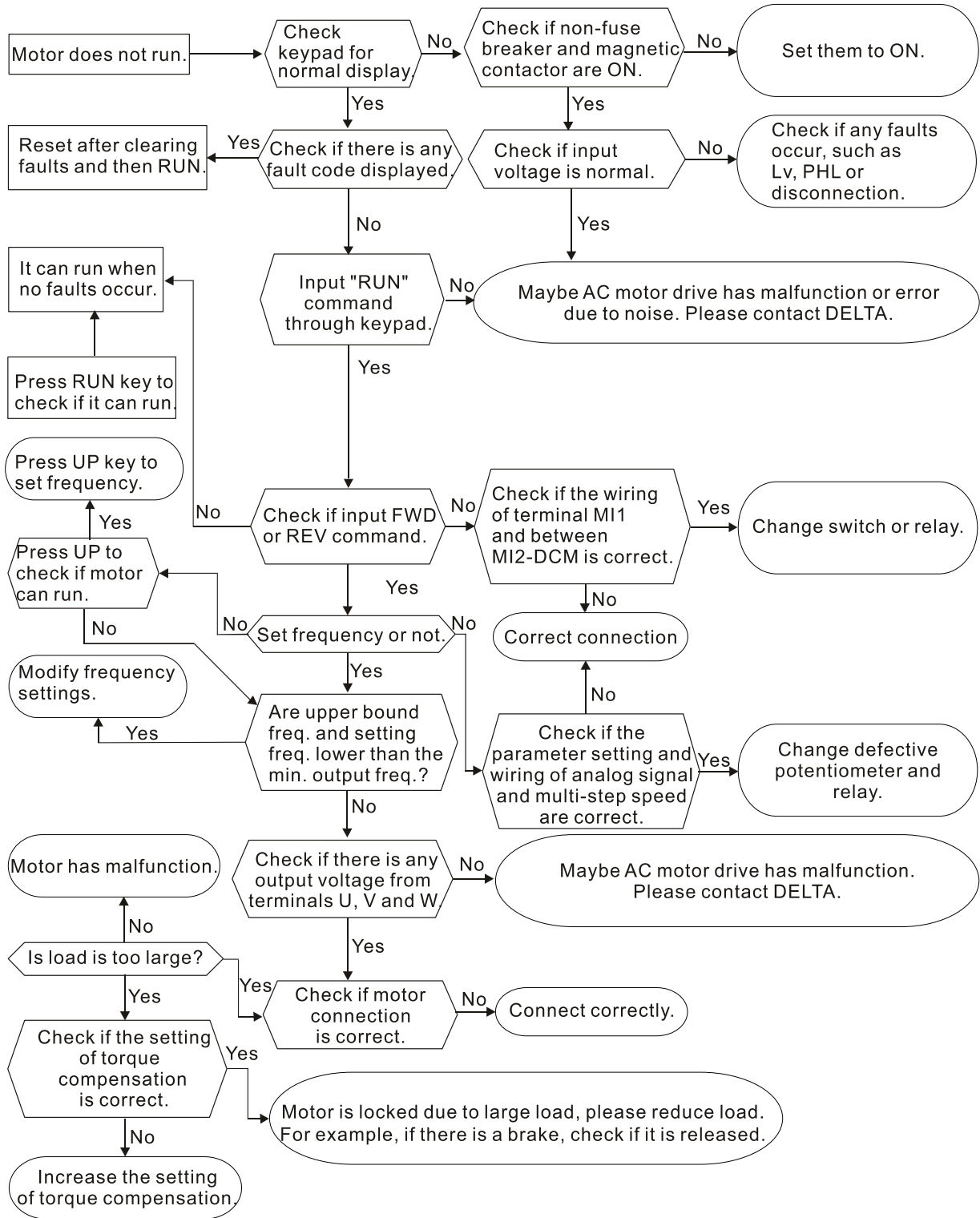

5-9 Motor Speed Cannot be Changed

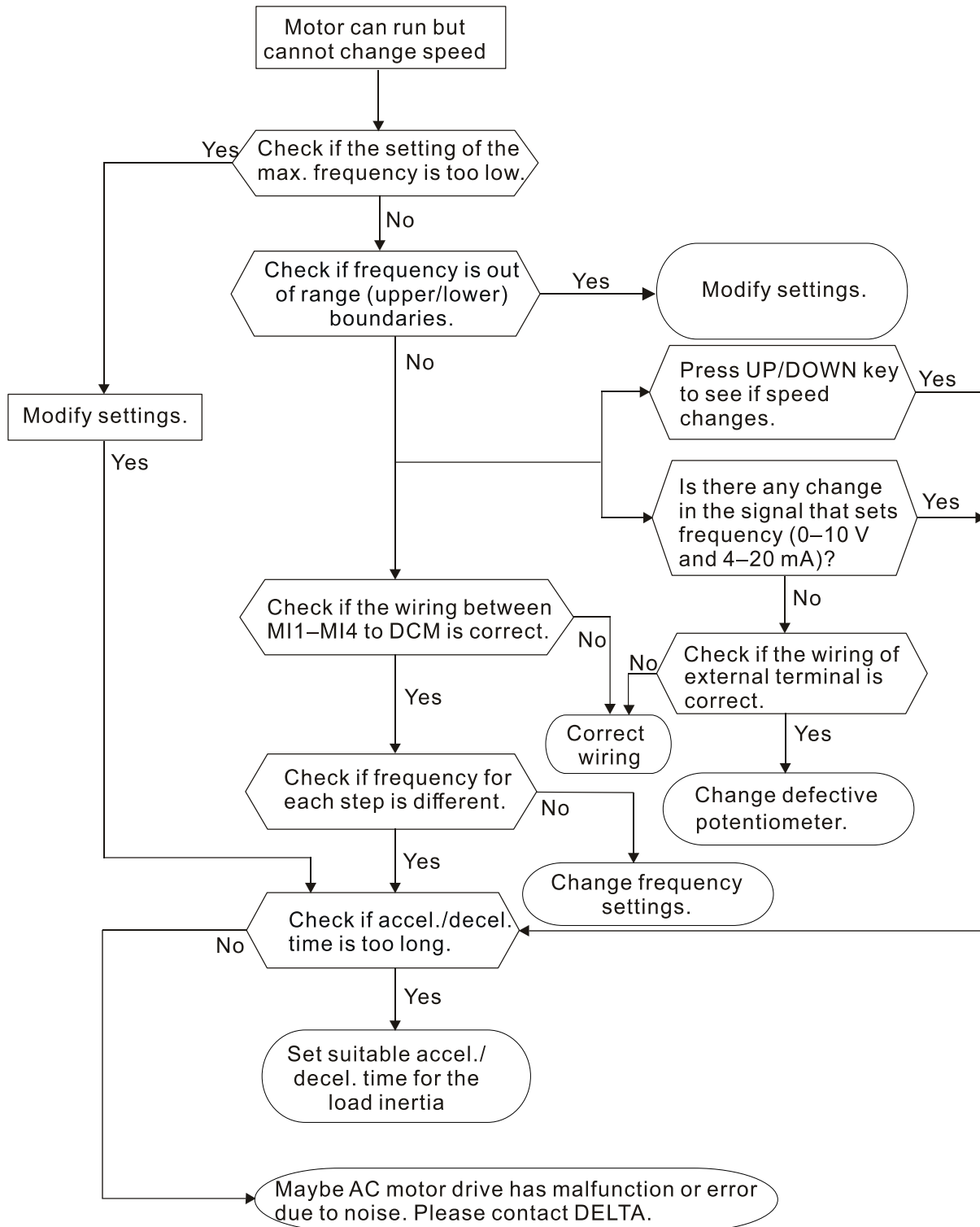

5-10 Motor Stalls during Acceleration

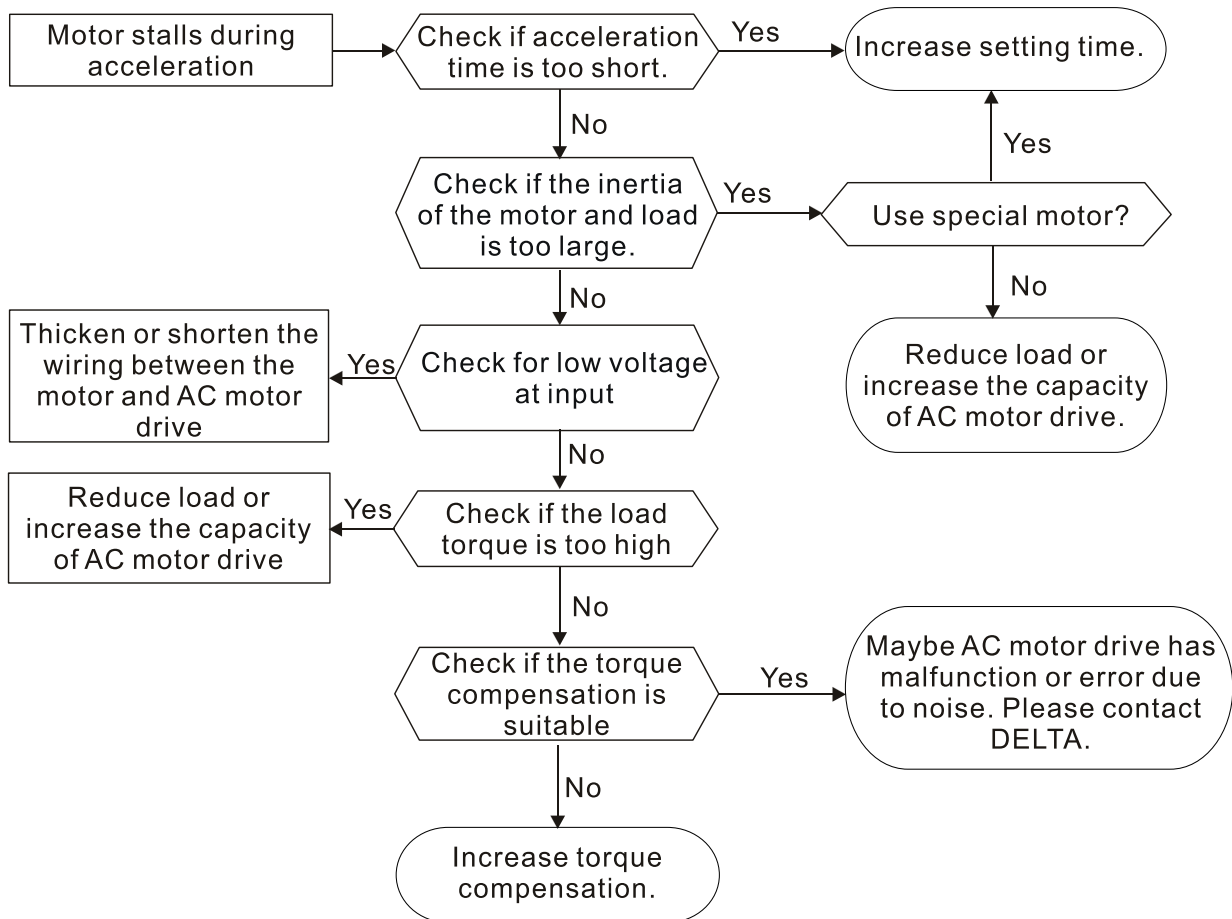

Chapter 5 Troubleshooting | VFD-EL-W

5-11 The Motor Does Not Run as Expected

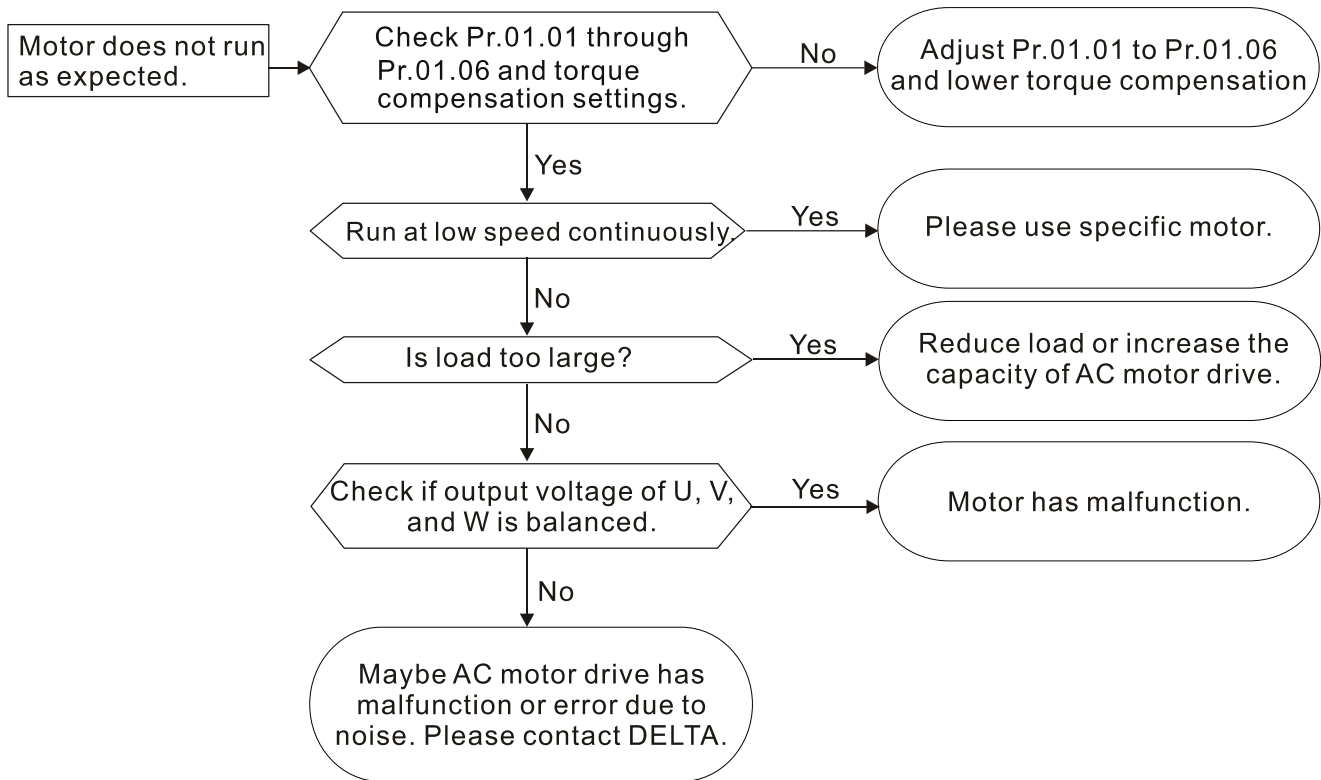

5-12 Electromagnetic/Induction Noise

Many sources of noise surround AC motor drives and affect them by radiation or conduction. This may cause the control circuits to malfunction and even damage the AC motor drive. Of course, there are solutions to increase the noise tolerance of an AC motor drive, but this has its limits. Solving the problem from the outside as follows is the best.

1. Add a surge suppressor on the relays and contacts to suppress switching surges.
2. Shorten the length of the wiring for the control circuit or serial communication and keep them separated from the power circuit wiring.
3. Comply with the wiring regulations by using shielded wires and isolation amplifiers for long wire length.
4. The grounding terminal must comply with the local regulations and be grounded independently; that is, do not use a common ground with electric welding machines and other power equipment.
5. Connect a noise filter at the mains input terminal of the AC motor drive to filter noise from the power circuit.

In short, solutions for electromagnetic noise exist of “no product” (disconnect disturbing equipment), “no spread” (limit emission from disturbing equipment) and “no receive” (enhance immunity).

5-13 Operating Environment Condition

Since the AC motor drive is an electronic device, you must deal with the operating environment conditions. Here are some remedial measures to use if necessary.

1. To prevent vibration, anti-vibration dampers are the last choice. Vibration must be within the specification. Vibration causes mechanical stress and it should not occur frequently, continuously or repeatedly to prevent damage to the AC motor drive.
2. Store the AC motor drive in a clean and dry location, free from corrosive fumes/dust to prevent corrosion and poor contacts. Poor insulation in a humid location can cause short circuits. If necessary, install the AC motor drive in a dust-proof and painted enclosure. If necessary in particular situations, use a completely sealed enclosure.
3. The ambient temperature should be within the specification. Too high or too low temperature affects the lifetime and reliability of the AC motor drive. For semiconductor components, damage occurs once any specification is out of range. It is necessary to periodically check air quality and the cooling fan and provide extra cooling if required. In addition, the microcomputer may not work in extremely low temperatures, making cabinet heating necessary.
4. Store the AC motor drive in a relative humidity range of 0% to 90% (non-condensing). Use an air conditioner and/or desiccator if necessary.

5-14 Affecting Other Machines

An AC motor drive may affect the operation of other machines due to many reasons. Some solutions are listed below:

High Harmonics at Power Side

You can reduce high harmonics at the power side during running.

1. Separate the power system: use a transformer for the AC motor drive.
2. Use a reactor at the power input terminal of the AC motor drive.
3. If using phase lead capacitors (never on the AC motor drive output!), use serial reactors to prevent damage to the capacitors from high harmonics.

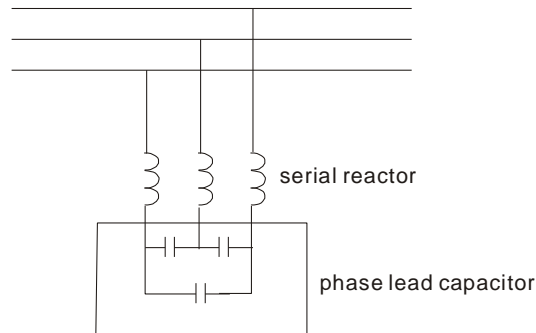

Motor Temperature Rises

When the motor is a standard induction motor with a fan, the cooling will be insufficient at low speed, causing the motor to overheat. In addition, high harmonics at the output increases copper and core losses. Use the following measures depending on load and operation range.

1. Use a motor with independent ventilation (forced external cooling) or increase the motor rated power.
2. Use a special inverter-duty motor.
3. Do NOT run at low speed for long periods of time.

Chapter 5 Troubleshooting | VFD-EL-W

[This page is intentionally left blank]

Chapter 6 Fault Code Information and Maintenance

6-1 Fault Code Information

6-2 Maintenance and Inspections

Chapter 6 Fault Code Information and Maintenance | VFD-EL-W

The AC motor drive has various warnings and protections against errors such as over-voltage, low voltage, or over-current. Once an error occurs, the protections activate, the AC motor drive stops output, activates the error contacts, and the motor coasts to stop. Please refer to the error display from the AC motor drive and look up the corresponding causes and solutions. The fault record is stored in the AC motor drive internal memory and can store the five most recent error messages. You can read it from the digital keypad or through the communications by accessing the parameters.

The AC motor drive includes a large number of electronic components, including ICs, resistors, capacitors, transistors, and cooling fans. These components do not last forever. Even under normal circumstances, they will eventually become error-prone if used past their lifespans. Therefore, you must perform periodic preventive maintenance to identify defective and worn out parts, and eliminate the causes of malfunctions in the AC motor drive at an early stage. At the same time, parts that have exceeded their product life should be replaced whenever possible to ensure safe operation.





Visual checks should be done regularly to monitor the AC motor drive's operation, and to make sure nothing unusual happens. Check the situations listed in the following table.



- Wait five seconds after a fault has been cleared before pressing RESET with the input terminal keypad.
- The drive must first be switched off for at least five minutes for ≤ 22 kW models until the charging indicator turns off before it is safe to open the cover to begin maintenance operations.
- Only qualified personnel can work on maintenance or replace parts. (Remove metal items such as watch, rings, and other metal items before operation, and use only insulated tools.)
- Never modify internal components or wiring.
- The performance and the surrounding environment should meet the standard specifications. There should be no abnormal noise, vibration, or odor.
- Verify if the keypad displays normally. Check if there is any abnormality such as overheating or color change. Prevent the drive from electronic shock and equipment accident.

6-1 Fault Code Information

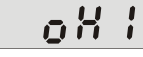







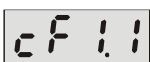

The following messages display when the operation command source is set as digital keypad.

Fault Name	Fault Descriptions	Corrective Actions
	<p>Over-current Abnormal increase in current.</p>	<ol style="list-style-type: none"> 1. Check if the motor power corresponds with the AC motor drive output power. 2. Check the wiring connections to U/T1, V/T2, and W/T3 for possible short circuits. 3. Check the wiring connections between the AC motor drive and motor for possible short circuits, and for short to ground. 4. Check for loose contacts between the AC motor drive and the motor. 5. Increase the Acceleration Time. 6. Check for possible excessive loading on the motor.
	<p>Over-voltage The DC bus voltage exceeds its maximum allowable value.</p>	<ol style="list-style-type: none"> 1. Check if the input voltage is in the rated AC motor drive input voltage range. 2. Check for possible voltage transients. 3. DC bus over-voltage may also be caused by motor regeneration. Either increase the Deceleration Time or add an optional brake resistor (and brake unit).
	<p>Overheating Heat sink temperature is too high.</p>	<ol style="list-style-type: none"> 1. Ensure that the ambient temperature is in the specified temperature range. 2. Make sure that the ventilation holes are not obstructed. 3. Provide enough spacing for adequate ventilation. (see Chapter 1)
	<p>Low voltage The AC motor drive detects that the DC bus voltage has fallen below its minimum value.</p>	<ol style="list-style-type: none"> 1. Check whether the input voltage is in the AC motor drive rated input voltage range. 2. Check for abnormal load on the motor. 3. Check for correct input power wiring to R-S-T (for three-phase models) without phase loss.
	<p>Overload The AC motor drive detects excessive drive output current. NOTE: The AC motor drive can withstand up to 150% of the rated current for a maximum of 60 seconds.</p>	<ol style="list-style-type: none"> 1. Check whether the motor is overloaded. 2. Reduce the torque compensation setting (Pr.07.02). 3. Use the next higher power AC motor drive model.



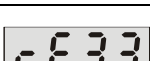
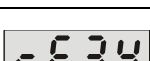
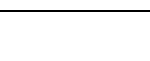

Chapter 6 Fault Code Information and Maintenance | VFD-EL-W

Fault Name	Fault Descriptions	Corrective Actions
ol1	Overload 1 Internal electronic overload trip	<ol style="list-style-type: none"> 1. Check for possible motor overload. 2. Check the electronic thermal overload setting. 3. Replace the drive with a larger capacity model. 4. Reduce the current level so that the drive output current does not exceed the value in the Motor Rated Current (Pr.07.00).
ol2	Overload 2 Motor overload.	<ol style="list-style-type: none"> 1. Reduce the motor load. 2. Adjust the over-torque detection settings to appropriate values (Pr.06.03–Pr.06.05).
HPF1	CC (current clamp)	Return the unit to the factory.
HPF2	OV hardware fault	Return the unit to the factory.
HPF4	OC hardware fault	
bb	External Base Block <ol style="list-style-type: none"> 1. When the external input terminals (B.B) (MI1–MI4) are active, the AC motor drive stops output. 2. When changing the communication address 2002H bit2 = 1, the drive stops output. 	The “bb” disappears once the signal source is cleared.
ocA	Over-current during acceleration	<ol style="list-style-type: none"> 1. Check if the screws between the drive and motor are loosen. 2. Check for possible poor insulation between the U-V-W terminals to the motor. 3. Increase the Acceleration Time. 4. Decrease the torque compensation setting (Pr.07.02). 5. Replace the drive with a larger capacity model.
ocd	Over-current during deceleration	<ol style="list-style-type: none"> 1. Check for possible poor insulation between the U-V-W terminals to the motor. 2. Increase the Deceleration Time. 3. Replace the drive with a larger capacity model.
ocn	Over-current during constant speed operation	<ol style="list-style-type: none"> 1. Check for possible poor insulation between the U-V-W terminals to the motor. 2. Check for possible motor stall. 3. Replace the drive with a larger capacity model.

Chapter 6 Fault Code Information and Maintenance | VFD-EL-W

Fault Name	Fault Descriptions	Corrective Actions
	External Fault 1. When multi-function input terminals (MI1–MI4) are set to external fault, the AC motor drive stops output. 2. When changing the communication address 2002H bit0 = 1, the drive stops output.	The “EF” disappears once the signal source is cleared and reset.
	Internal EEPROM cannot be programmed.	Return the unit to the factory.
	Internal EEPROM cannot be programmed.	Return the unit to the factory.
	Internal EEPROM cannot be read.	1. Press RESET key to reset all parameters to defaults. 2. If the fault still exists, return the unit to the factory.
	Internal EEPROM cannot be read.	1. Press RESET key to reset all parameters to defaults. 2. If the fault still exists, return the unit to the factory.
	Wiring detection fault	U-phase error, return the unit to the factory.
	Wiring detection fault	V-phase error, return the unit to the factory.
	Wiring detection fault	W-phase error, return the unit to the factory.
	Wiring detection fault	DC bus wiring detection error, return the unit to the factory.
	Wiring detection fault	Temperature sensor error, return the unit to the factory.
	Auto-acceleration/deceleration failure	1. Check if the motor is suitable for operation by the AC motor drive. 2. Check if the regenerative energy is too high. 3. Check for sudden load changes.
	Communication Fault	1. Check the RJ45 connection between the AC motor drive for loose wires and wiring to the correct pins. 2. Check if the communication protocol is properly set. 3. Refer to Parameter Group 09 Communication Parameters in Chapter 4 for detailed information.
	PID feedback signal fault	1. Check the parameter settings (Pr.10.01) and AVI/ACI wiring. 2. Check for possible fault between the system response time and the PID feedback signal detection time (Pr.10.08)

Chapter 6 Fault Code Information and Maintenance | VFD-EL-W

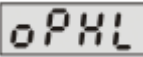
Fault Name	Fault Descriptions	Corrective Actions
	Software protection failure	Password locked.
	Analog signal error	Check if the wiring for ACI is broken.
	Unusual PID feedback	Check if wiring for PID feedback is correct and the parameter of PID feedback is properly set.
	Phase Loss	Check if the input power is three-phase.
	Multi-motor fault protection	Check if the motor wiring is normal.

Reset

Press the “RESET” key (as shown in the figure below) to reset the external terminal after the fault is cleared, and set this terminal to be ON or send the Reset command through communication, then the trip is cleared. Make sure the RUN command or signal is OFF before executing RESET to prevent damage to the drive or personal injury due to immediate operation after reset.



Digital Keypad for EL-W

6-2 Maintenance and Inspections

Before the check-up, always turn off the AC input power for at least five minutes and remove the cover. Even if the power has been turned off, a charge may still remain in the filter capacitors with hazardous voltages before the power is OFF. Make sure the voltage is lower than 25 V_{DC} before you perform any inspections.

Ambient environment

Items to Check	Methods and Criterion	Maintenance Period		
		Daily	Half Year	One Year
Check the ambient temperature, humidity, vibration and for any dust, gas, oil or water drops.	Visual inspection and measurement with equipment with standard specifications	○		
Check for any dangerous objects in the environment.	Visual inspection	○		

Voltage

Items to Check	Methods and Criterion	Maintenance Period		
		Daily	Half Year	One Year
Check if the voltages of the main circuit and control circuit are correct.	Measure with multi-meter with standard specifications.	○		

Digital keypad display

Items to Check	Methods and Criterion	Maintenance Period		
		Daily	Half Year	One Year
Check that the display is clear for reading.	Visual inspection	○		
Check for any missing characters in the display.	Visual inspection	○		

Mechanical parts

Items to Check	Methods and Criterion	Maintenance Period		
		Daily	Half Year	One Year
Check for any abnormal sounds or vibrations.	Visual and auditory inspection		○	
Check for any loose screws.	Tighten the screws		○	
Check for deformed or damaged parts.	Visual inspection		○	
Check for any color change due to overheating.	Visual inspection		○	
Check for any dust or dirt.	Visual inspection		○	

Chapter 6 Fault Code Information and Maintenance | VFD-EL-W**Main circuit**

Items to Check	Methods and Criterion	Maintenance Period		
		Daily	Half Year	One Year
Check for any loose or missing screws.	Tighten or replace the screws.	○		
Check for any deformed, cracked, or damaged machinery or insulation and for any color change due to overheating or ageing.	Visual inspection		○	
Check for any dust or dirt.	Visual inspection		○	

Main circuit terminals and wiring

Items to Check	Methods and Criterion	Maintenance Period		
		Daily	Half Year	One Year
Check for wiring color change or deformation due to overheating.	Visual inspection		○	
Check for wiring insulation damage or color change.	Visual inspection		○	

Main circuit terminal block

Items to Check	Methods and Criterion	Maintenance Period		
		Daily	Half Year	One Year
Check for any damage.	Visual inspection		○	

Main circuit filter capacity

Items to Check	Methods and Criterion	Maintenance Period		
		Daily	Half Year	One Year
Check for any leakage of liquid, color change, cracking or deformation.	Visual inspection	○		
Check if the safety valve is not removed or if the valve is obviously expanded.	Visual inspection	○		
Measure static capacity when required	Static capacity \geq initial value X 0.85		○	

Main circuit resistor

Items to Check	Methods and Criterion	Maintenance Period		
		Daily	Half Year	One Year
Check for any peculiar odors or insulation cracking due to overheating.	Visual inspection, smell.		○	
Check for any disconnections.	Visual inspection		○	
Check for damaged connections	Measure the resistor value with a multi-meter		○	

Main circuit transformer and reactor

Items to Check	Methods and Criterion	Maintenance Period		
		Daily	Half Year	One Year
Check for any abnormal vibrations or peculiar odors.	Visual, auditory inspection and smell.	○		

Main circuit electromagnetic contactor and relay

Items to Check	Methods and Criterion	Maintenance Period		
		Daily	Half Year	One Year
Check for any vibration sounds.	Auditory inspection.	○		
Check that the contact works correctly.	Visual inspection	○		

Main circuit printed circuit board and connector

Items to Check	Methods and Criterion	Maintenance Period		
		Daily	Half Year	One Year
Check for any loose screws and connectors.	Tighten the screws.		○	
Check for any peculiar odors or color changes.	Visual inspection and smell		○	
Check for any cracking, damage, deformation or corrosion.	Visual inspection		○	
Check for any leakage of liquid or deformation in the capacitors.	Visual inspection		○	

Cooling system cooling fan

Items to Check	Methods and Criterion	Maintenance Period		
		Daily	Half Year	One Year
Check for any abnormal sounds or vibrations.	Visual, auditory inspection and turn the fan by hand (turn off the power first) to check for smooth rotation.			○
Check for any loose screws.	Tighten the screws.			○
Check for any color change due to overheating.	Change fan.			○

Cooling system ventilation channel

Items to Check	Methods and Criterion	Maintenance Period		
		Daily	Half Year	One Year
Check for any obstruction around the heat sink, air intake or air outlet.	Visual inspection		○	

NOTE: Use chemically neutral cloth to clean and use a dust cleaner to remove dust when necessary.

Chapter 6 Fault Code Information and Maintenance | VFD-EL-W

[This page intentionally left blank.]

Appendix A. Specifications

A-1 230V 1 ϕ Models

A-2 460V 3 ϕ Models

A-3 General Specifications

A-4 Environment for Operation, Storage and Transportation

A-5 Derating Curve for Ambient Temperature and Carrier Frequency

Appendix A Specifications | VFD-EL-W

The VFD-EL-W Series include the 230V and 460V models. The 230V model is one-phase; the 460V model is three-phase. Refer to following specifications for details.

NOTE:

1. VFD-EL-W has two types of packaging: Individual Package [suffixed with (-1) at the end of the model name] and 12 pcs/ carton.
2. The electrical specifications are the same for either packaging.

A-1 230V 1 ϕ Models

Model Number VFD□□□EL21W (-1)		002	004	007	015	022
Max. Applicable Motor Output (kW)		0.2	0.4	0.75	1.5	2.2
Max. Applicable Motor Output (HP)		0.25	0.5	1.0	2.0	3.0
Output Rating	Rated Output Capacity (kVA)	0.6	1.0	1.6	2.9	4.2
	Rated Output Current (A)	1.6	2.5	4.2	7.5	11.0
	Maximum Output Voltage (V)	Three-phase Proportional to Input Voltage				
	Output Frequency (Hz)	0.1–400				
	Carrier Frequency (kHz)	2–12 (default: 8)				
Input Rating	Rated Input Current (A)	4.9	6.5	9.3	15.7	24.0
	Rated Voltage/Frequency	One-phase, 200–240 V, 50 / 60 Hz				
	Voltage Tolerance	$\pm 10\%$ (180–264 V)				
	Frequency Tolerance	$\pm 5\%$ (47–63 Hz)				
Cooling Method		Convective Cooling			Fan Cooling	
Weight (kg)		1.0	1.0	1.0	1.4	1.4

Appendix A Specifications | VFD-EL-W**A-2 460V 3 ϕ Models**

Model Number VFD□□□EL21W (-1)		004	007	015	022	040	055
Max. Applicable Motor Output (kW)		0.4	0.75	1.5	2.2	4.0	5.5
Max. Applicable Motor Output (HP)		0.5	1.0	2.0	3.0	5.5	7.5
Output Rating	Rated Output Capacity (kVA)	1.2	2.0	3.3	4.4	7.4	9.9
	Rated Output Current (A)	1.5	2.5	4.2	5.5	9.0	13.0
	Maximum Output Voltage (V)	Three-phase Proportional to Input Voltage					
	Output Frequency (Hz)	0.1–400					
	Carrier Frequency (kHz)	2–12 (default: 8)					2–12 (default: 4)
Input Rating	Rated Input Current (A)	1.8	3.2	4.3	7.1	10.0	14.0
	Rated Voltage/Frequency	Three-phase, 380–480V, 50 / 60Hz					
	Voltage Tolerance	$\pm 10\%$ (342–528 V)					
	Frequency Tolerance	$\pm 5\%$ (47–63 Hz)					
Cooling Method		Convective Cooling			Fan Cooling		
Weight (kg)		1.0	1.0	1.0	1.4	1.4	1.5

A-3 General Specifications

Characteristics		Descriptions	
Control Characteristics	Control System	SPWM (Sinusoidal Pulse Width Modulation) control (V/F control)	
	Frequency Setting Resolution	0.01 Hz	
	Output Frequency Resolution	0.01 Hz	
	Torque Characteristics	Includes the auto-torque/auto-slip compensation; starting torque can be 150% at 5.0 Hz	
	Overload Tolerance	150% of rated current for one minute	
	Skip Frequency	Three zones, setting range 0.1–400 Hz	
	Accel/Decel Time	0.1–600 seconds (2 Independent settings for Accel./ Decel. time)	
	Stall Prevention Level	Setting 20–250% of rated current	
	DC Brake	Operation frequency 0.1–400.0 Hz, output 0–100% rated current Start time 0–60 seconds, stop time 0–60 seconds	
	V/F Pattern	Adjustable V/F pattern	
Operating Characteristics	Frequency Setting	Keypad	Setting by ▲ ▼
		External Signal	Potentiometer-5 k Ω / 0.5 W, 0–10 V _{DC} , 4–20 mA, RS-485 interface; Multi-function inputs 2 to 4 (7 steps, Jog, up/down)
	Operation Setting Signal	Keypad	Set by RUN and STOP
		External Signal	Single-wire (default setting MI1) or Two-wire/Three-wire (MI1, MI2, MI3) by setting parameters, JOG operation, RS-485 serial interface (Modbus).
	Multi-function Input Signal	Multi-step selection 0–7, Jog, accel./decel. inhibit, two accel./decel. switches, counter, external Base Block, ACI/AVI selections, drive reset, UP/DOWN key settings, NPN/PNP input selection	
	Multi-function Output Indication	AC drive operating, frequency reached, zero speed, Base Block, fault indication, overheat alarm, emergency stop and status selections for input terminals.	
	Analog Output Signal	Output frequency/current	
Operation Functions	AVR, accel./decel. S-Curve, over-voltage/over-current stall prevention, five fault records, reverse inhibition, momentary power loss restart, DC brake, auto-torque/slip compensation, auto-tuning, adjustable carrier frequency, output frequency limits, parameter lock/reset, PID control, external counter, Modbus communication, abnormality reset, abnormality restart, power-saving, fan control, sleep/wake frequency, first/second frequency source selections, first/second frequency source combination, NPN/PNP selection.		
Protection Functions	Over-voltage, over-current, under-voltage, external fault, overload, ground fault, overheating, electronic thermal, IGBT short circuit, PTC		
Display Keypad	Six-key, seven-segment LED with four-digits, four status LEDs, master frequency, output frequency, output current, custom units, parameter values for setup and lock, faults, RUN, STOP, RESET, FWD/REV.		

Appendix A Specifications | VFD-EL-W**A-4 Environment for Operation, Storage and Transportation**

	Built-in EMI Filter	N/A
Environmental Conditions	Enclosure Rating	IP20
	Pollution Degree	2
	Installation Location	Altitude 1,000 m or lower, keep from corrosive gasses, liquid and dust.
	Ambient Temperature	Non-condensing, non-freezing -10–50°C [40°C for side-by-side mounting, excluding VFD007EL21W(-1)] -10–40°C [VFD007EL21W(-1), ambient temperature exceeding 40°C may reduce the service life of the drive]
	Storage/ Transportation Temperature	-20–60°C
	Ambient Humidity	Below 90% RH (non-condensing)
	Vibration	1.0 mm, peak to peak 2–13.2 Hz; 0.7–1.0 G, 13.2–55 Hz; 1.0 G, 55–512 Hz; compliance with IEC 60068-2-6
Certifications	CE, RoHS, GB 12668.3, KC (Only individually packaged)	

A-5 Derating Curve for Ambient Temperature and Carrier Frequency

Ambient Temperature Derating Curve

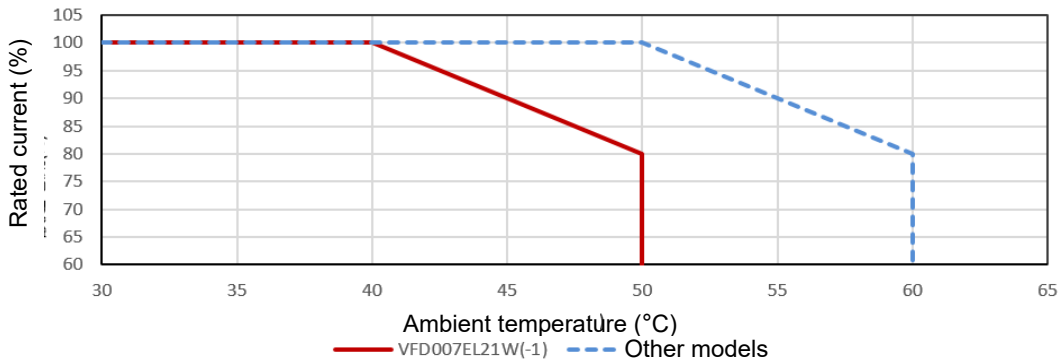

Model	Ambient Temperature Limitation
VFD007EL21W(-1)	If the AC motor drive operates at the rated current, the ambient temperature needs to be between -10–40°C. If the temperature is above 40°C, decrease 2% of the rated current for every 1°C increase in temperature. The maximum allowable temperature is 50°C.
Other models	If the AC motor drive operates at the rated current, the ambient temperature needs to be between -10–50°C. If the temperature is above 50°C, decrease 2% of the rated current for every 1°C increase in temperature. The maximum allowable temperature is 60°C.

Carrier Frequency Derating Curve

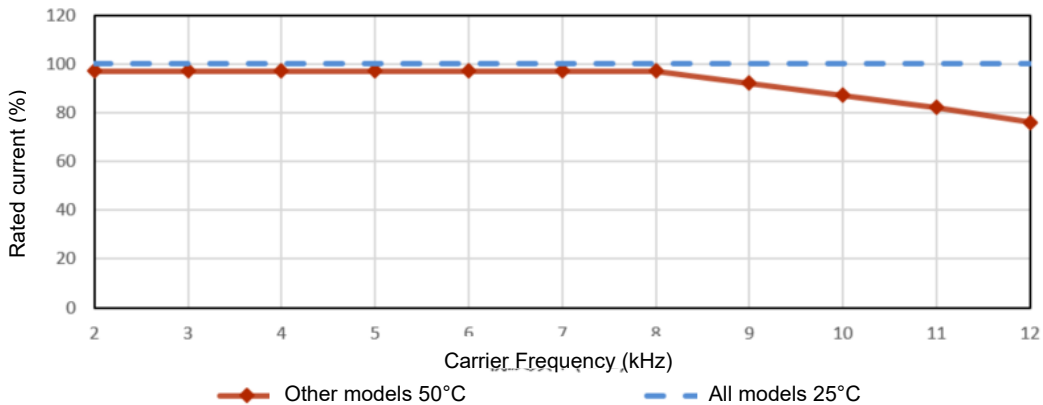
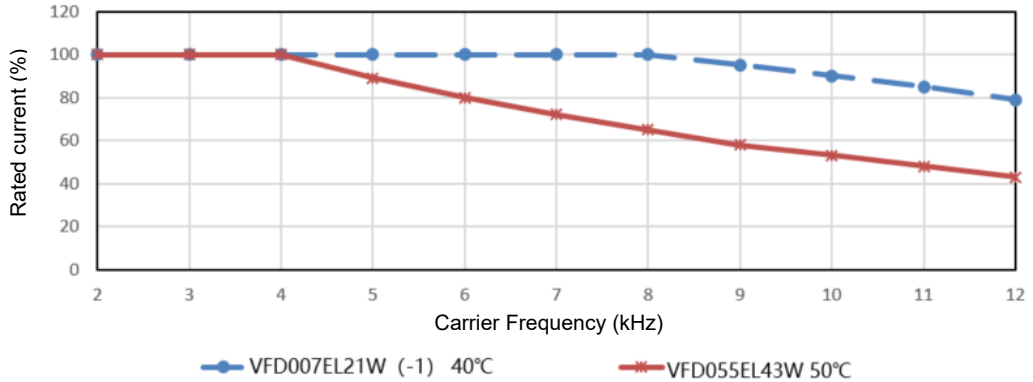

Appendix A Specifications | VFD-EL-W

Model	Carrier Frequency Limitation
VFD007EL21W(-1)	If the AC motor drive is installed at an ambient temperature of 40°C, and operates at the rated current, the carrier frequency needs to be within 8 kHz. If the carrier frequency is higher than 8 kHz, decrease 5% of the rated current for every 1 kHz increase in the carrier frequency. The maximum allowable carrier frequency is 12 kHz.
VFD055EL43W	If the AC motor drive is installed at an ambient temperature of 50°C, and operates at the rated current, the carrier frequency needs to be within 4 kHz. If the carrier frequency is higher than 4 kHz, decrease 5% of the rated current for every 1 kHz increase in the carrier frequency. The maximum allowable carrier frequency is 12 kHz.
Other models	If the AC motor drive is installed at an ambient temperature of 50°C, and operates at the rated current, the carrier frequency needs to be within 8 kHz. If the carrier frequency is higher than 8 kHz, decrease 5% of the rated current for every 1 kHz increase in the carrier frequency. The maximum allowable carrier frequency is 12 kHz.

Appendix B. Accessories

B-1 Non-fuse Circuit Breaker Chart

B-2 Reactor

B-3 Digital Keypad

B-4 Auxiliary Cooling Fan

Appendix B. Accessories | VFD-EL-W**B-1 Non-fuse Circuit Breaker Chart**

For one-phase/ three-phase drives, the current rating of the breaker must be between 2–4 times the rated input current.

One-phase		Three-phase	
Model	Recommended non-fuse breaker (A)	Model	Recommended non-fuse breaker (A)
VFD002EL21W(-1)	10	VFD004EL43W(-1)	5
VFD004EL21W(-1)	15	VFD007EL43W(-1)	5
VFD007EL21W(-1)	20	VFD015EL43W(-1)	10
VFD015EL21W(-1)	30	VFD022EL43W(-1)	15
VFD022EL21W(-1)	50	VFD040EL43W(-1)	20
		VFD055EL43W(-1)	30

Fuse Specification Chart

Fuse specifications lower than the table below are allowed.

Model	I (A) Input	I (A) Output	Line Fuse	
			I (A)	Bussmann P/N
VFD002EL21W(-1)	4.9	1.6	10	JJN-10
VFD004EL21W(-1)	6.5	2.5	15	JJN-15
VFD004EL43W(-1)	1.8	1.5	5	JJS-6
VFD007EL21W(-1)	9.3	4.2	20	JJN-20
VFD007EL43W(-1)	3.2	2.5	5	JJS-6
VFD015EL21W(-1)	15.7	7.5	30	JJN-30
VFD015EL43W(-1)	4.3	4.2	10	JJS-10
VFD022EL21W(-1)	24.0	11.0	50	JJN-50
VFD022EL43W(-1)	7.1	5.5	15	JJS-15
VFD040EL43W(-1)	10.0	9.0	20	JJN-20
VFD055EL43W(-1)	14.0	13.0	30	JJS-30

B-2 Reactor

B-2-1 AC Reactor

AC Input Reactor Recommended Value

230V, 50/60Hz, One-Phase

kW	HP	Fundamental Amps	Max. continuous Amps	Inductance (mH)	
				3–5% Impedance	
0.2	0.25	4	6	6.5	
0.4	0.5	5	7.5	3	
0.75	1	8	12	1.5	
1.5	2	12	18	1.25	
2.2	3	18	27	0.8	

460V, 50/60Hz, Three-Phase

kW	HP	Fundamental Amps	Max. continuous Amps	Inductance (mH)	
				3% Impedance	5% Impedance
0.4	0.5	2	3	20	32
0.75	1	4	6	9	12
1.5	2	4	6	6.5	9
2.2	3	8	12	5	7.5
4.0	5.5	8	12	3	5
5.0	7.5	12	18	2.5	4.2

AC Output Reactor Recommended Value

230V, 50/60Hz, Three-Phase

kW	HP	Fundamental Amps	Max. continuous Amps	Inductance (mH)	
				3% Impedance	5% Impedance
0.2	0.25	4	6	9	12
0.4	0.5	4	6	6.5	9
0.75	1	8	12	3	5
1.5	2	8	12	1.5	3
2.2	3	12	18	1.25	2.5

460V, 50/60Hz, Three-Phase

kW	HP	Fundamental Amps	Max. continuous Amps	Inductance (mH)	
				3% Impedance	5% Impedance
0.4	0.5	2	3	20	32
0.75	1	4	6	9	12
1.5	2	4	6	6.5	9
2.2	3	8	12	5	7.5
4.0	5.5	12	18	3	5
5.5	7.5	18	27	1.5	2.5

Applications

Connected in input circuit

Application 1

When more than one AC motor drives are connected to the same mains power and are running, and one of them is ON during operation.

Issues: When applying power to one of the AC motor drives, the charge current of the capacitors may cause voltage dip. The AC motor drive may be damaged when over-current occurs during operation.

Correct wiring:

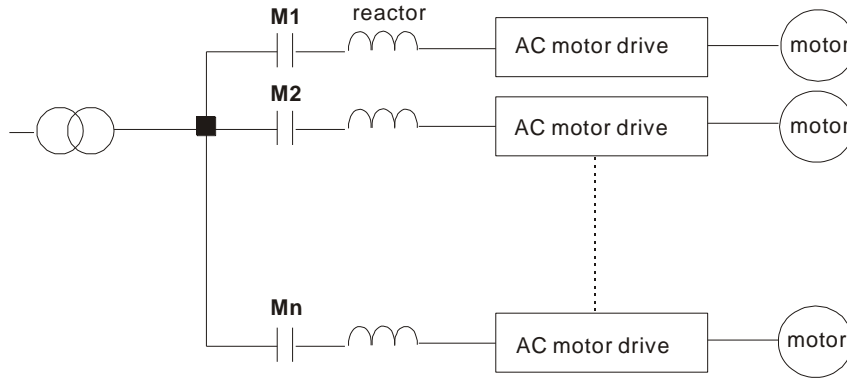

Application 2

A silicon rectifier and AC motor drive are connected to the same power.

Issues: Switching spikes are generated when the silicon rectifier switches ON/OFF. These spikes may damage the mains circuit.

Correct wiring:

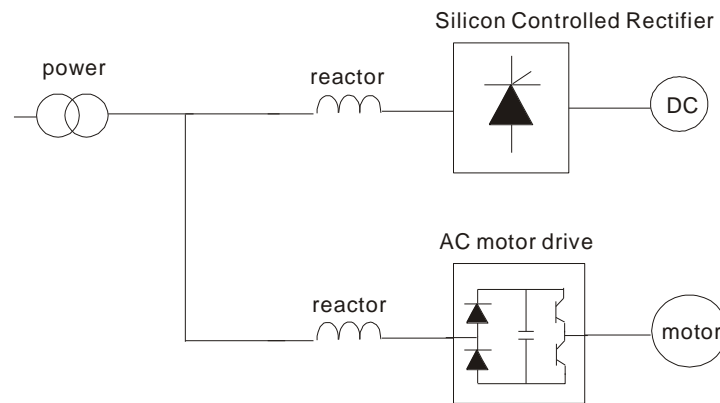

Application 3

The power supply capacity is 10 or above times the AC motor drive capacity.

Issues: When the mains power capacity is too large, line impedance is small and the charge current is too high. This may damage the AC motor drive due to the higher rectifier temperature.

Correct wiring:

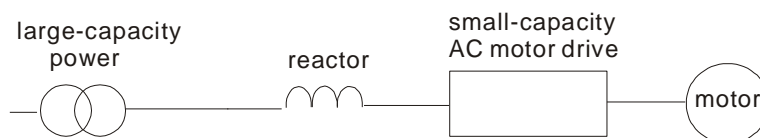

B-2-2 Zero Phase Reactor

RF220X00A

UNIT: mm [inch]

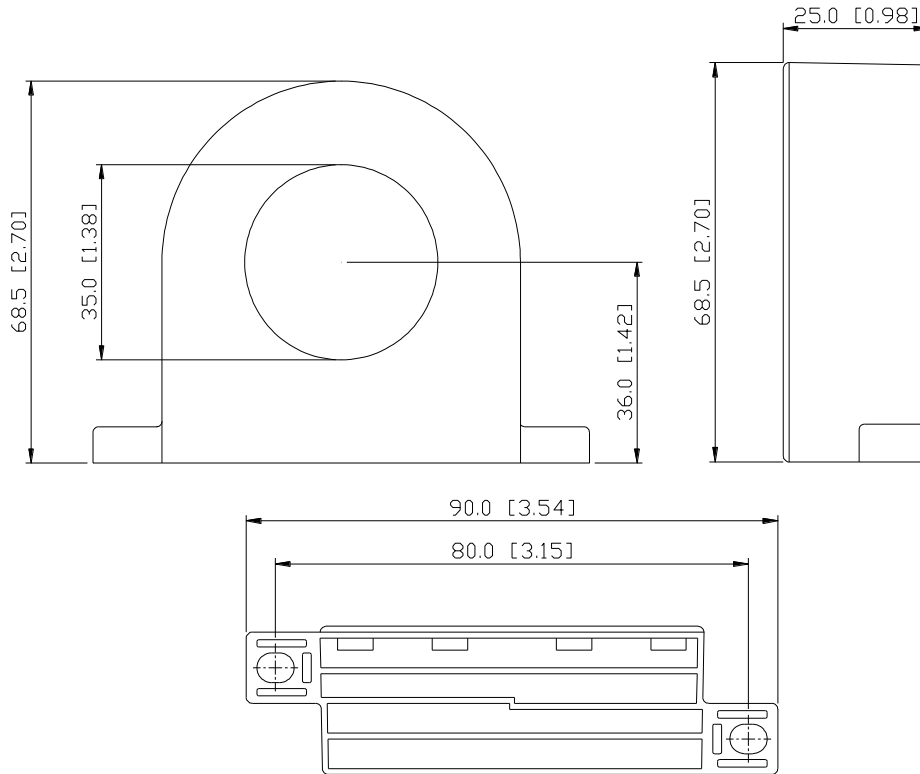

Cable Type (Note)	Recommended Wire Size			Qty.	Wiring Method
	AWG	mm ²	Nominal (mm ²)		
Single-core	≤ 10	≤ 5.3	≤ 5.5	1	Diagram A
	≤ 2	≤ 33.6	≤ 38	4	Diagram B
Three-core	≤ 12	≤ 3.3	≤ 3.5	1	Diagram A
	≤ 1	≤ 42.4	≤ 50	4	Diagram B

Diagram A

Please wind each wire four times around the core. The reactor must be put as close to the inverter output as possible.

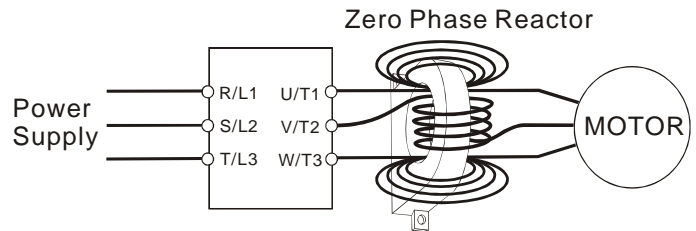
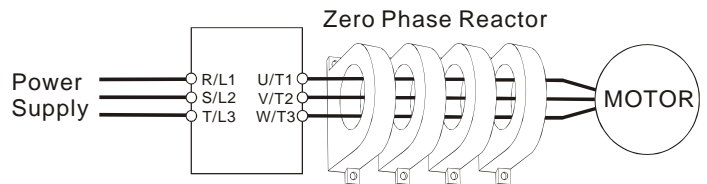

Diagram B

Please put all wires through four cores in series without winding.



NOTE:

600V Insulated Unshielded Cable

1. The table above gives approximate wire size for zero phase reactors, but the selection is ultimately governed by the type and diameter of the cable; that is, the cable must fit through the center hole of zero phase reactors.
2. When wiring, do not pass the grounding cable through the zero phase reactor; only pass the motor wire or power cable through the zero phase reactor.
3. With longer motor cables the zero-phase reactor can effectively reduce interference at the motor output.

B-3 Digital Keypad

B-3-1 Digital Keypad VFD-PU06

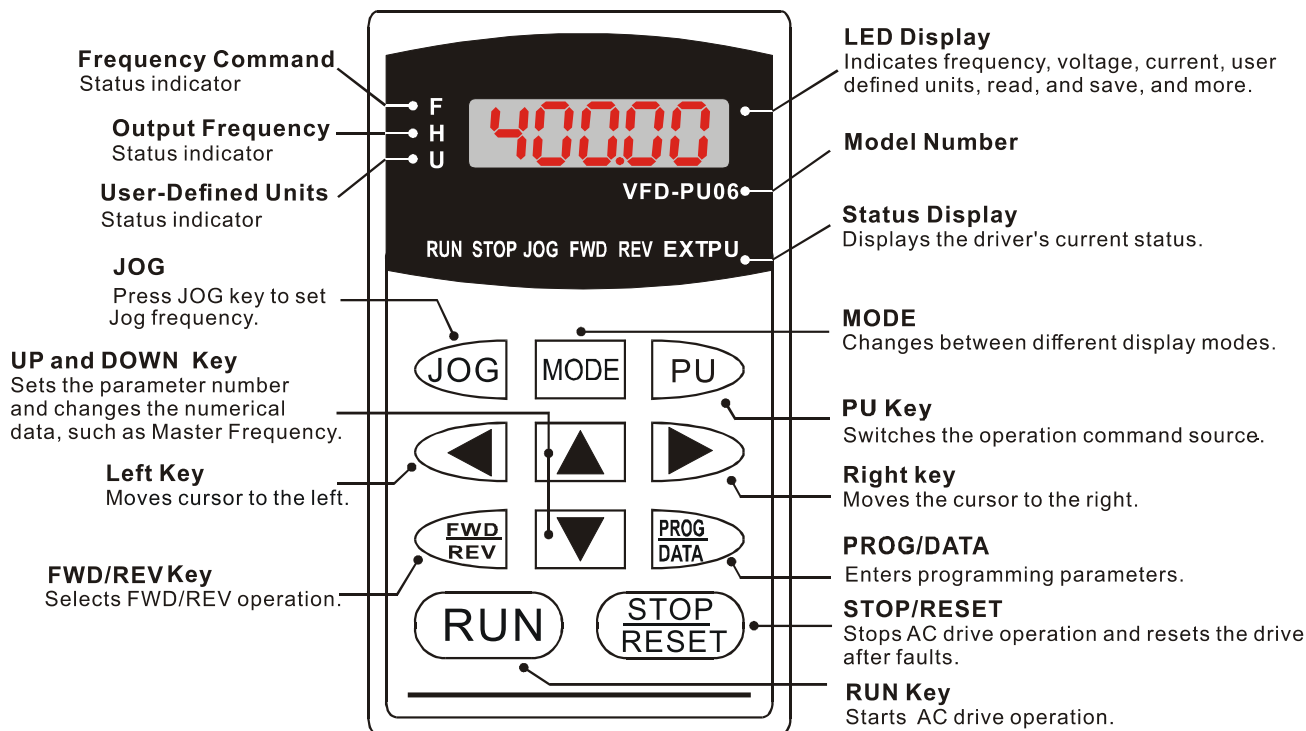

Display Message Explanation

Display Message	Descriptions
	The current frequency of the drive.
	The actual operation frequency that the drive outputs to the motor.
	The user-defined unit (u)
	The loading current of the drive.
	Read parameters. Press PROG/DATA for 2–3 sec. until it is flashing. Then, you can read four parameters from the AC motor drive to the digital keypad PU06 (read D0–read D3). Press UP or DOWN key to change to SAVE function.
	Write parameters. Press PROG/DATA for 2–3 sec. until it is flashing. Then, you can write the parameters from the digital keypad PU06 to the AC motor drive. Press UP or DOWN key to change to READ function.
	The specified parameter setting.
	The actual value stored in the specified parameter.
	External Fault

Display Message	Descriptions
	"End" displays for approximately one second if the entered input data has been accepted. After a parameter value has been set, the new value is automatically stored in memory.
	"Err" displays if the input is invalid or the input exceeds the setting range.
	Communication Error. Refer to Parameter Group 09 in Chapter 04 for details.

PU06 Operation Flow Chart

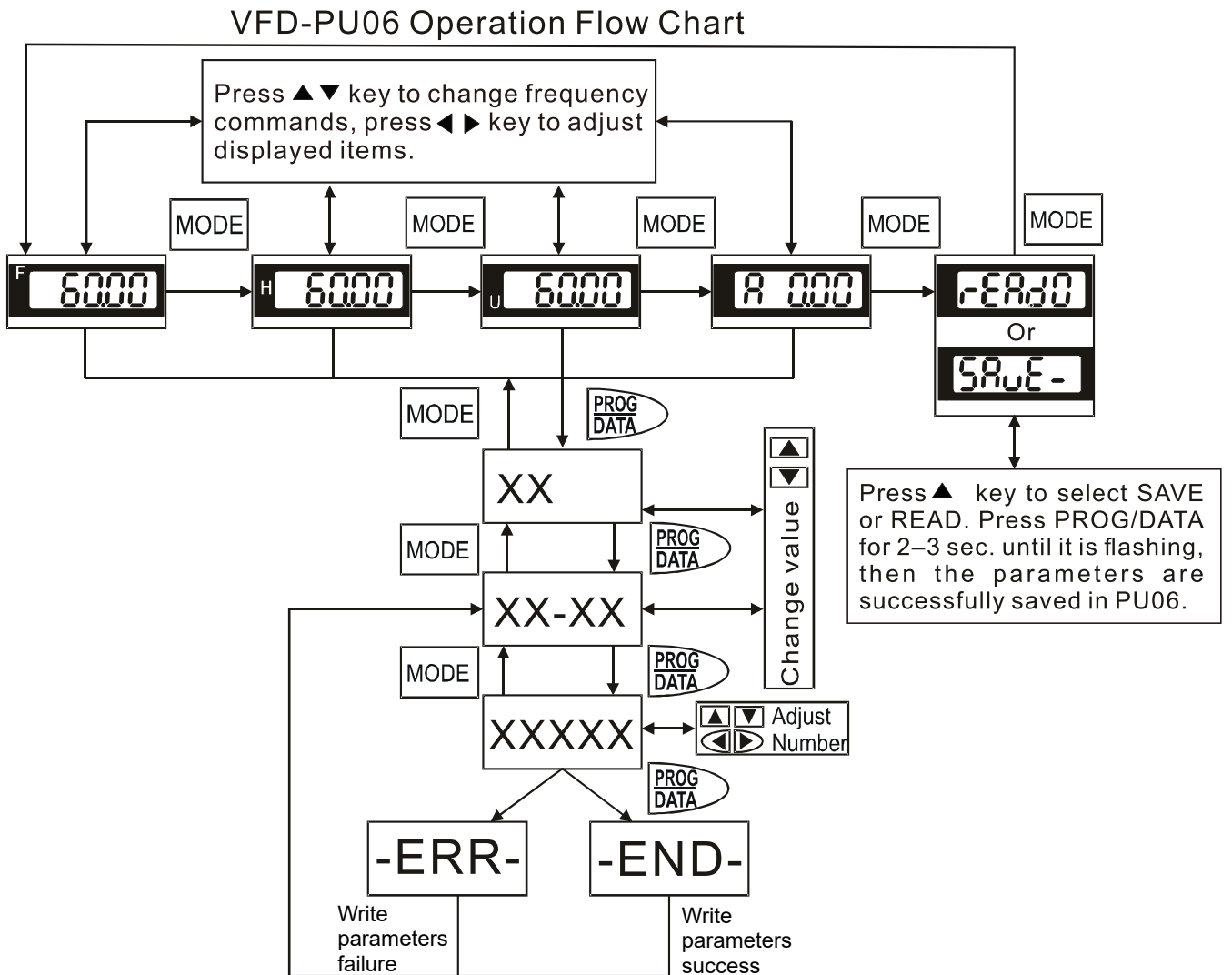

B-3-2 Digital Keypad VFD-PU08 / VFD-PU08V

VFD-PU08 Dimension

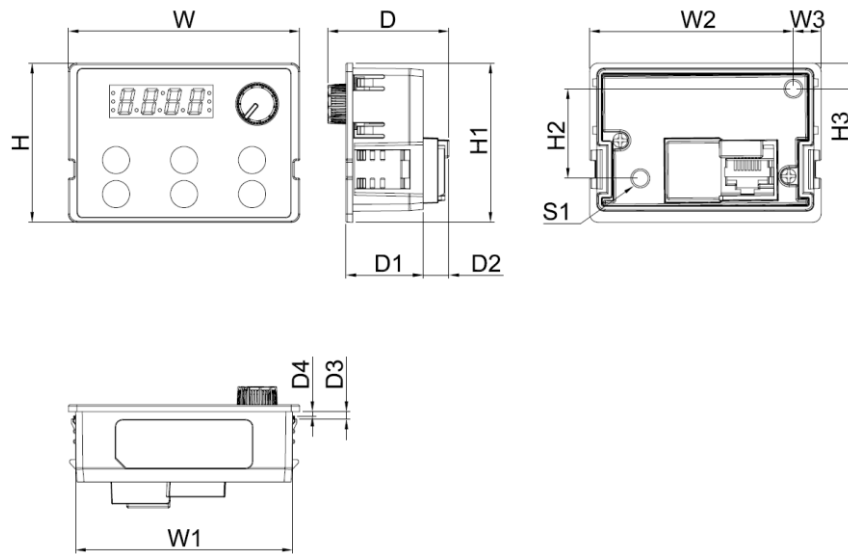

Unit: mm (inch)

W	W1	W2	W3	H	H1	H2	H3	D	D1	D2	D3	D4	S1
68.0 (2.68)	63.8 (2.51)	59.9 (2.36)	8.1 (0.32)	46.8 (1.84)	42.0 (1.65)	26.3 (1.04)	7.5 (0.30)	35.6 (1.40)	22.7 (0.89)	7.6 (0.30)	2.2 (0.09)	1.3 (0.05)	M3*0.5 (2X)

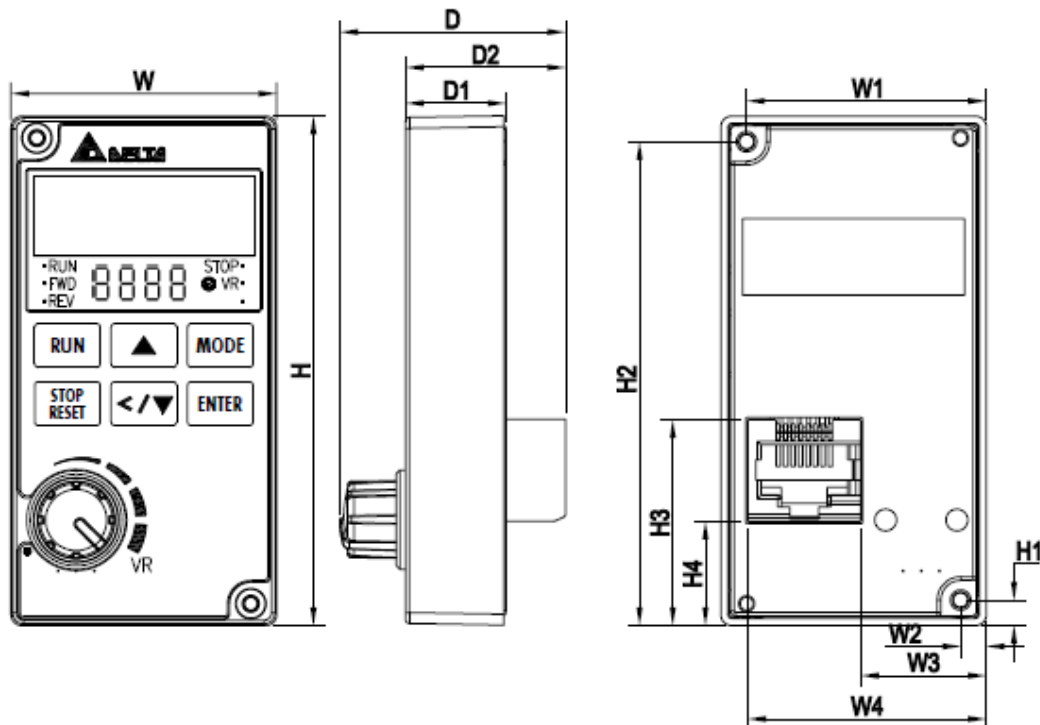

VFD-PU08V Dimension



Unit: mm (inch)

W1	W2	W3	W4	W	H1	H2	H3	H4	H	D1	D2	D
32.9 (1.30)	3.6 (0.14)	17.3 (0.68)	32.8 (1.29)	36.5 (1.44)	3.5 (0.14)	66.5 (2.62)	28.3 (1.11)	14.3 (0.56)	70.0 (2.76)	13.8 (0.54)	22.0 (0.87)	31.0 (1.22)

VFD-PU08 / VFD-PU08V Specification

<p>VFD-PU08</p> 	<table border="1"> <thead> <tr> <th>Items</th> <th>Description</th> </tr> </thead> <tbody> <tr> <td>Applicable VFD series</td> <td>ME300 and VFD-EL-W</td> </tr> <tr> <td>Communication Interface</td> <td>RS485 (exclusive mode), the host cannot use this interface when occupying.</td> </tr> <tr> <td>Installation</td> <td>VFD-PU08 fixed by plastic hook or screw. VFD-PU08V fixed by screws.</td> </tr> <tr> <td>IP Level</td> <td>Front panel: IP20. Back panel: IP00.</td> </tr> <tr> <td>Connector</td> <td>RJ45</td> </tr> <tr> <td>Max. length of extension cable</td> <td>5m</td> </tr> <tr> <td>Panel Display</td> <td>4-digits display with decimal point</td> </tr> <tr> <td>Core Functionality</td> <td>Read and Write, status display, operation instruction via RS485.</td> </tr> </tbody> </table>	Items	Description	Applicable VFD series	ME300 and VFD-EL-W	Communication Interface	RS485 (exclusive mode), the host cannot use this interface when occupying.	Installation	VFD-PU08 fixed by plastic hook or screw. VFD-PU08V fixed by screws.	IP Level	Front panel: IP20. Back panel: IP00.	Connector	RJ45	Max. length of extension cable	5m	Panel Display	4-digits display with decimal point	Core Functionality	Read and Write, status display, operation instruction via RS485.
Items	Description																		
Applicable VFD series	ME300 and VFD-EL-W																		
Communication Interface	RS485 (exclusive mode), the host cannot use this interface when occupying.																		
Installation	VFD-PU08 fixed by plastic hook or screw. VFD-PU08V fixed by screws.																		
IP Level	Front panel: IP20. Back panel: IP00.																		
Connector	RJ45																		
Max. length of extension cable	5m																		
Panel Display	4-digits display with decimal point																		
Core Functionality	Read and Write, status display, operation instruction via RS485.																		
<p>VFD-PU08V</p> 																			

NOTE:

The VFD-PU08 does not include the extension cord. Please choose the suitable extension cords as needed. (Refer to the table below)

Communication cable

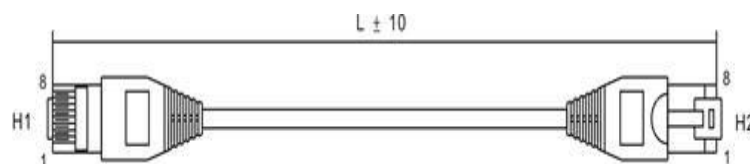



No.	Model Name	L	
		mm	inch
1	UC-CMC003-01A	300	11.8
2	UC-CMC005-01A	500	19.6
3	UC-CMC010-01A	1000	39.0
4	UC-CMC015-01A	1500	59.0
5	UC-CMC020-01A	2000	78.7
6	UC-CMC030-01A	3000	118.1
7	UC-CMC050-01A	5000	196.8











Appendix B. Accessories | VFD-EL-W

Status displayed

Status displayed	Note
	RUN: VFD is running
	FWD: VFD is running forwardly
	REV: VFD is running reversely
	STOP: VFD is stopped
	STOP Flashing: VFD is stopping
	VR light on: VFD potentiometer function is enabled VR light off: Direction function key (Up) and Direction function key (Down & left) is enabled

Button functionality

	To change the different mode selection	Press MODE button for 2 seconds, when "X" flashing: Direction function key "<" is enabled, Direction function key "▼" is disabled. Press MODE button for 2 seconds, when "X" stop flashing: Direction function key "<" is disabled, Direction function key "▼" is enabled.
	Decrease / Shift	Press Direction function key "▼" to decrease the value. Press Direction function key "<" to shift the set value and parameter.

- When  always on, you can press the  +  key combination to switch the up key  and <SHIFT> / down key  to adjust the frequency command of the inverter, and  will turn off at the same time.
- If  is off, press the MODE + ENTER key combination again, it will switch back to the state of adjusting the frequency by the panel potentiometer and  will lights up.
- When  is off, the frequency is adjusted by the up and down keys. It will not be maintained when the power is turned off. When the VFD-PU08 is powered on again, it is still adjusted by the panel potentiometer and  will lights up.

B-4 Auxiliary Cooling Fan

After VFD007EL21W(-1) installing the auxiliary cooling fan, the upper limit of the ambient operating temperature is increased to 50°C without derating. If the auxiliary cooling fan is not installed, the upper limit of the ambient operating temperature is 40°C without derating. The fan power is 24V, which can be taken from the drive control terminal +24V/DCM. If this fan is used, it is not allowed to connect other loads except the MI terminal for normal use in order to avoid overloading the +24V terminal and damage the drive.

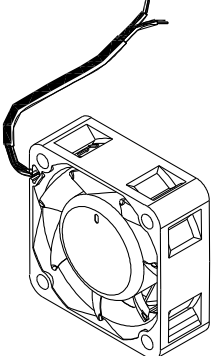
Fan Model	Model	Fan Kit
MKEL-AFKM1	VFD007EL21W(-1)	

NOTE: The fan cable is about 150mm.

Fan installation

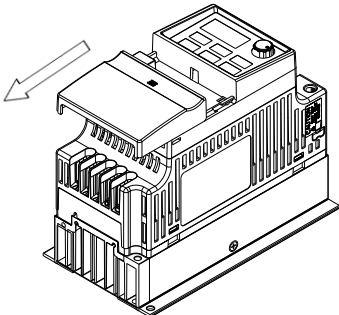
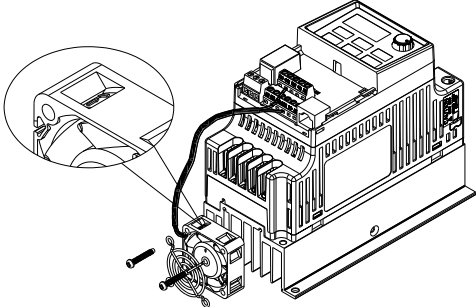
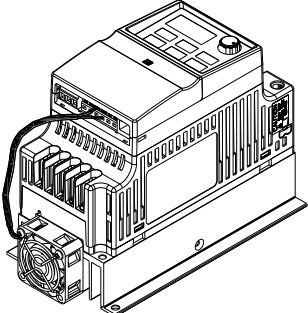
1. Remove the front cover.	
2. Place the fan as shown on the right, the arrow on the fan points to the heat sink, and use screws to assemble the fan net and the fan on the heat sink. Positive electrode: Red line to +24V Negative electrode: Black line to DCM	
3. Replace the upper cover, complete the fan installation.	

Appendix B. Accessories | VFD-EL-W

[This page is intentionally left blank]

Appendix C. How to Select the Right AC Motor Drive

C-1 Capacity Formulas

C-2 General Precautions

C-3 How to Choose a Suitable Motor

Appendix C. How to Select the Right AC Motor Drive | VFD-EL-W

The choice of the right AC motor drive for the application is very important and has a big influence on the drive's lifetime. If the capacity of the AC motor drive is too large, it cannot provide complete protection to the motor and motor might be damaged. If the capacity of the AC motor drive is too small, it cannot provide the required performance and the AC motor drive might be damaged due to overloading.

Simply selecting the AC motor drive with the same capacity as the motor cannot completely meet the application requirements. Therefore, a designer should consider all the conditions, including load types, load speeds, load characteristics, operation methods, rated output, rated speed, power and the change in load capacity. The following table lists the factors you need to consider, depending on your requirements.

Item		Related Specification			
		Speed and Torque Characteristics	Time Ratings	Overload Capacity	Starting Torque
Load type	Friction load and weight load Liquid (viscous) load Inertia load Load with power transmission	•			•
Load speed and torque characteristics	Constant torque Constant output Decreasing torque Decreasing output	•	•		
Load characteristics	Constant load Shock load Repetitive load High starting torque Low starting torque	•	•	•	•
Operation mode	Continuous operation Short-time operation Long-time operation at medium/low speeds		•	•	
Rated output	Maximum output current (instantaneous) Constant output current (continuous)	•		•	
Rated speed	Maximum frequency Base frequency	•			
Power supply	Power supply transformer capacity or percentage impedance Voltage fluctuations and unbalance Number of phases, single phase protection Frequency			•	•
Load capacity change	Mechanical friction, losses in wiring			•	•
	Duty cycle modification		•		

C-1 Capacity Formulas

1. One AC motor drive operates one motor

The starting capacity should be less than 1.5x the rated capacity of the AC motor drive.

The starting capacity equals:

$$\frac{k \times N}{973 \times \eta \times \cos \phi} \left(T_L + \frac{GD^2}{375} \times \frac{N}{t_A} \right) \leq 1.5 \times \text{the_capacity_of_AC_motor_drive(kVA)}$$

2. One AC motor drive operates more than one motor

- The starting capacity should be less than the rated capacity of the AC motor drive.

Acceleration time ≤ 60 seconds

The starting capacity equals:

$$\frac{k \times N}{\eta \times \cos \phi} \left[n_r + n_s(k_s - 1) \right] = P_{Cl} \left[1 + \frac{n_s}{n_r} (k_s - 1) \right] \leq 1.5 \times \text{the_capacity_of_AC_motor_drive(kVA)}$$

Acceleration time ≥ 60 seconds

The starting capacity equals:

$$\frac{k \times N}{\eta \times \cos \phi} \left[n_r + n_s(k_s - 1) \right] = P_{Cl} \left[1 + \frac{n_s}{n_r} (k_s - 1) \right] \leq \text{the_capacity_of_AC_motor_drive(kVA)}$$

- The current should be less than the rated current of the AC motor drive (A).

Acceleration time ≤ 60 seconds

$$n_r + I_M \left[1 + \frac{n_s}{n_r} (k_s - 1) \right] \leq 1.5 \times \text{the_rated_current_of_AC_motor_drive(A)}$$

Acceleration time ≥ 60 seconds

$$n_r + I_M \left[1 + \frac{n_s}{n_r} (k_s - 1) \right] \leq \text{the_rated_current_of_AC_motor_drive(A)}$$

- When running continuously

The load capacity requirement should be less than the capacity of the AC motor drive (kVA).

The load capacity requirement equals:

$$\frac{k \times P_M}{\eta \times \cos \phi} \leq \text{the_capacity_of_AC_motor_drive(kVA)}$$

The motor capacity should be less than the capacity of the AC motor drive.

$$k \times \sqrt{3} \times V_M \times I_M \times 10^{-3} \leq \text{the_capacity_of_AC_motor_drive(kVA)}$$

The current should be less than the rated current of the AC motor drive (A).

$$k \times I_M \leq \text{the_rated_current_of_AC_motor_drive(A)}$$

Appendix C. How to Select the Right AC Motor Drive | VFD-EL-W**Symbol explanation**

P_M	Motor shaft output for load (kW)
η	Motor efficiency (normally approx. 0.85)
$\cos \varphi$	Motor power factor (normally approx. 0.75)
V_M	Motor rated voltage (V)
I_M	Motor rated current (A), for commercial power
k	Correction factor calculated from the current distortion factor (1.05–1.1, depending on PWM method)
P_{C1}	Continuous motor capacity (kVA)
k_s	Starting current/rated current of the motor
n_r	Number of motors in parallel
n_s	Number of simultaneously started motors
GD^2	Total inertia (GD^2) calculated back to motor shaft (kg m^2)
T_L	Load torque
t_A	Motor acceleration time
N	Motor speed

C-2 General Precautions

Selecting an AC Motor Drive

1. When connecting the AC motor drive directly to a large-capacity power transformer (600 kVA or higher), or when switching a phase lead capacitor, excess peak currents may occur in the power input circuit and may damage the converter section. To avoid this, use an AC input reactor (optional) before the AC motor drive mains input to reduce the current and improve the input power efficiency.
2. When using a special motor or when driving more than one motor in parallel with a single AC motor drive, select the AC motor drive current to be $\geq 1.25x$ (sum of the motor rated currents).
3. The starting acceleration and deceleration characteristics of a motor are limited by the AC motor drive rated current and the overload protection. Compared to running the motor D.O.L. (Direct On-Line), you can expect a lower starting torque output with the AC motor drive. If a higher starting torque is required (such as for elevators, mixers, tooling machines, etc.), use a higher capacity AC motor drive or increase the capacities of both the motor and the AC motor drive.
4. When a fault occurs on the drive, a protective circuit is activated and the AC motor drive output is turned off. The motor coasts to stop. For an emergency stop, use an external mechanical brake to quickly stop the motor.

Setting Parameters

1. You can set the AC motor drive to an output frequency up to 400 Hz (less for some models) with the digital keypad. Setting errors may create a dangerous situation. For safety, setting an upper limit frequency function is strongly recommended.
2. High DC brake operating voltages and long operation time (at low frequencies) may cause overheating of the motor. In that case, forced external motor cooling is recommended.
3. Motor acceleration and deceleration time is determined by motor rated torque, load torque, and load inertia.
4. If you activate the stall prevention function, the acceleration and deceleration time is automatically extended to a length that the AC motor drive can handle. If the motor must decelerate within a certain time with a higher load inertia than the AC motor drive can handle in the required time, either use an external brake resistor and/or a brake unit (depending on the model) to shorten deceleration time only, or increase the capacity of both the motor and the AC motor drive.

Appendix C. How to Select the Right AC Motor Drive | VFD-EL-W

C-3 How to Choose a Suitable Motor

Standard Motors

When using the AC motor drive to operate a standard three-phase induction motor, follow these precautions.

- ☑ The energy loss is greater than that for an inverter-duty motor.
- ☑ Avoid running the motor at low speed for a long time. Under this condition, the motor temperature may rise above the motor rating due to limited airflow produced by the motor's fan. Consider adding external forced motor cooling.
- ☑ When the standard motor operates at low speed for a long time, the output load must be decreased.
- ☑ The load tolerance of a standard motor is according to the following diagram.

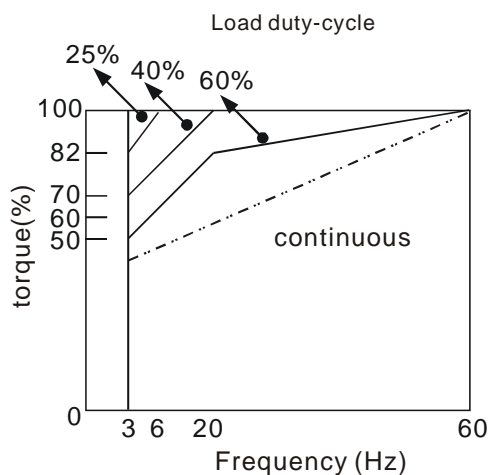

- ☑ If 100% of continuous torque is required at low speed, it may be necessary to use a special inverter-duty motor.
- ☑ Motor dynamic balance and rotor endurance should be considered once the operating speed exceeds the rated speed (60Hz) for a standard motor.
- ☑ Motor torque characteristics vary when driving the motor with an AC motor drive instead of a commercial power supply. Check the load torque characteristics of the machine connected to the motor.
- ☑ Because of the high carrier frequency PWM control of the VFD series, pay attention to the following motor vibration problems:
 - ☑ Resonant mechanical vibration: use anti-vibration dampers to mount equipment that runs at varying speed.
 - ☑ Motor imbalance: special care is required for operation at 60 Hz and higher frequencies.
 - ☑ The motor fan is very noisy when the motor speed exceeds 60 Hz or above.

Special Motors

- ☑ Pole-changing (Dahlander) motor:
The rated current differs from that of a standard motor. Check before operation and carefully choose the capacity of the AC motor drive. When changing the number of poles, stop the motor first. If over-current occurs during operation or the regenerative voltage is too high, let the motor free run to stop (coast).
- ☑ Submersible motor:
The rated current is higher than that of a standard motor. Check before operation and carefully choose the capacity of the AC motor drive. A long motor cable between the AC motor drive and the motor reduces the available motor torque.
- ☑ Explosion-proof (Ex) motor:
Must be installed in a safe place and the wiring should comply with the (Ex) requirements. Delta AC Motor Drives are not suitable for (Ex) areas that require special precautions.
- ☑ Gear reduction motor:
The lubricating method of the reduction gearbox and the speed range for continuous operation are different and depend on the motor brand. Carefully consider the lubricating method when operating for a long time at low speed and for high-speed operation.
- ☑ Synchronous motor:
The rated current and the starting current are higher than those of standard motors. Check before operation and carefully choose the capacity of the AC motor drive. When one AC motor drive operates more than one motors, pay attention to starting and changing the motor.

Power Transmission Mechanism

Pay attention to reduced lubrication when operating equipment such as gear reduction motors, gearboxes, belts and chains over long periods at low speeds. At high speeds (60 Hz and above), noises and vibrations that reduce the lifetime of the equipment may occur.

Motor Torque

The motor torque characteristics operated by an AC motor drive depend on the motor model selection and AC motor drive parameter settings.

Appendix C. How to Select the Right AC Motor Drive | VFD-EL-W

[This page is intentionally left blank]